

## ISCHESS – Integration of stochastic renewables in the Swiss electricity supply system

Alexander Fuchs<sup>A1</sup>, Turhan Demiray<sup>B1</sup>, Panos Evangelos<sup>C2</sup>, Ramachandran Kannan<sup>D2</sup>,  
Tom Kober<sup>E2</sup>, Christian Bauer<sup>F2</sup>, Warren Schenler<sup>G2</sup>, Peter Burgherr<sup>H2</sup> and Stefan  
Hirschberg<sup>I2</sup>

<sup>1</sup>ETH Zurich, Research Center for Energy Networks

<sup>2</sup>Paul Scherrer Institute, Laboratory for Energy Systems Analysis

---

<sup>A</sup>fuchs@fen.ethz.ch

<sup>B</sup>demirayt@fen.ethz.ch

<sup>C</sup>evangelos.panos@psi.ch

<sup>D</sup>kannan.ramachandran@psi.ch

<sup>E</sup>tom.kober@psi.ch

<sup>F</sup>christian.bauer@psi.ch

<sup>G</sup>warren.schenler@psi.ch

<sup>H</sup>peter.burgherr@psi.ch

<sup>I</sup>stefan.hirschberg@psi.ch

# Contents

- List of Figures** **i**
  
- List of Tables** **i**
  
- Executive Summary** **1**
  
- 1 Project Overview** **4**
  - 1.1 Project Scope . . . . . 4
  - 1.2 Project Workplan . . . . . 6
  
- 2 WP2: Technology Assessment** **13**
  - 2.1 Introduction . . . . . 13
  - 2.2 Objectives . . . . . 13
  - 2.3 Scope . . . . . 13
  - 2.4 Methodology . . . . . 14
  - 2.5 Results . . . . . 22
  - 2.6 Conclusions . . . . . 29
  - 2.7 Future work . . . . . 29
  
- 3 WP3: Distribution Grid Modelling** **32**
  - 3.1 Introduction . . . . . 32
  - 3.2 Objectives . . . . . 32
  - 3.3 Scope . . . . . 33
  - 3.4 Methodology - Grid optimization procedure . . . . . 33
  - 3.5 Methodology - Energy pattern generation . . . . . 35
  - 3.6 Results . . . . . 43
  - 3.7 Conclusions . . . . . 49
  - 3.8 Future Work . . . . . 52
  
- 4 WP4: Assessment of alternative RES integration strategies** **53**
  - 4.1 Introduction . . . . . 53
  - 4.2 Objectives . . . . . 53
  - 4.3 Scope . . . . . 53
  - 4.4 Methodology . . . . . 53
  - 4.5 Results . . . . . 58
  - 4.6 Conclusions . . . . . 74
  - 4.7 Future Work . . . . . 75
  
- 5 WP5: National Electricity Grid Model** **76**
  - 5.1 Introduction . . . . . 76
  - 5.2 Objectives . . . . . 76
  - 5.3 Scope . . . . . 76
  - 5.4 Methodology – Secure aggregation of detailed grid models . . . . . 76

5.5	Results . . . . .	77
5.6	Conclusions . . . . .	80
5.7	Future Work . . . . .	80
<b>6</b>	<b>WP6: Energy system modeling</b>	<b>81</b>
6.1	Introduction . . . . .	81
6.2	Objectives . . . . .	81
6.3	Scope . . . . .	81
6.4	Methodology . . . . .	82
6.5	Results . . . . .	86
6.6	Conclusions . . . . .	88
6.7	Future Work . . . . .	89
<b>7</b>	<b>WP7: Integration of energy system and grid modeling</b>	<b>90</b>
7.1	Introduction . . . . .	90
7.2	Objectives . . . . .	90
7.3	Scope . . . . .	90
7.4	Methodology . . . . .	90
7.5	Results . . . . .	98
7.6	Conclusions . . . . .	102
7.7	Future Work . . . . .	103
<b>8</b>	<b>WP8 – Assessment of different future energy scenarios</b>	<b>106</b>
8.1	Introduction . . . . .	106
8.2	Objectives . . . . .	106
8.3	Scope . . . . .	106
8.4	Methodology . . . . .	106
8.5	Results . . . . .	110
8.6	Conclusions . . . . .	137
8.7	Future Work . . . . .	139
<b>9</b>	<b>Final Conclusions and Recommendations</b>	<b>170</b>

## List of Figures

1.1	Project Work Plan	5
1.2	Graphical representation of work flow, data flow and interfaces	6
1.3	Color Map for task sharing	6
2.1	LCA scheme – framework for Life Cycle Assessment [23] arrows in both directions indicate iterative processes.	14
2.2	LCC levelized cost methodology	18
2.3	LCA results of batteries and hydrogen production; per kWh of storage capacity for batteries and per MJHLV of hydrogen, respectively	22
2.4	LCA results of electricity production and supply mixes in Switzerland; per kWh of electricity generated at PV modules and wind turbines, respectively, and per kWh supplied from the grid.	22
2.5	LCA results of electricity grid infrastructure components; per kg of transformer and per meter of power lines, respectively.	22
2.6	LCC results for storage technology options (Phase 2 EEM modeling).	23
2.7	PEM electrolyzer cost per kg of hydrogen for different plant sizes.	24
2.8	EPEX energy price data for hydrogen electrolysis.	24
2.9	Net revenue per kg for hydrogen electrolysis.	25
3.1	Example degradation curve of the battery cost model used in the distribution grid model (data used for Lithium-Ion models).	35
3.2	Typical load profile	36
3.3	Typical load profile (zoom) - weekly and daily pattern	37
3.4	Fourier analysis of 24 hour pattern over one year with seasonal approximation	39
3.5	Comparison of load pattern with generated approximation	40
3.6	Swiss load demand and PV injections from ES2050	41
3.7	Generated patterns for one week in July 2035	42
3.8	Rural section of a distribution grid with 390 nodes, 1 feeder (black square), 20 kV lines (red), 400 V lines (green) and 16 transformer (blue).	44
3.9	PV integration studies: Price profile $c_i$ over 24 hours, used at the feeder of the grid in Fig. 4.1.	45
3.10	PV integration studies: Total load in the grid over 24 hours (blue, summed over all nodes in the grid in Fig. 4.1) and solar radiation profile $r_{PV,i}$ (green, normalized to 1 MW).	46
3.11	PV integration studies regarding <i>Curtailment</i> : Grid PV power injections for different PV capacities. Maximum PV capacity without curtailment $P_{PV}^*$ (blue), $2 \cdot P_{PV}^*$ (green), $3 \cdot P_{PV}^*$ (red). Available PV power (dashed) and injected PV power (solid). Upper bound with theoretical maximum injections (bold black).	47
3.12	PV integration studies regarding <i>Curtailment</i> : Grid operation cost for different PV capacities. Maximum PV capacity without curtailment $P_{PV}^*$ (blue), $2 \cdot P_{PV}^*$ (green), $3 \cdot P_{PV}^*$ (red). Lower bound with theoretical maximum injections (bold black).	48

3.13	PV integration studies regarding <i>Storage</i> : Grid PV power injections for different storage levels. No storage (blue), Storage for 30 minutes PV injections (green), Storage for 1 hour PV injections (red). Available PV power (black dashed).	49
3.14	PV integration studies regarding <i>Storage</i> : Grid operation cost for different storage levels. No storage (blue), Storage for 30 minutes PV injections (green), Storage for 1 hour PV injections (red). Available PV power (black dashed).	50
3.15	PV integration studies regarding <i>Storage</i> : Total net storage flow of all storage devices. Storage accomodating 30 minutes PV injections (green),and 1 hour PV injections (red).	51
4.1	Distribution network Sursee-14 as part of the CKW network.	56
4.2	Simulation example: Electricity price profile	58
4.3	Simulation example: Aggregated load demand (red) and feeder power (blue).	59
4.4	Simulation example: Aggregated available PV power (blue), injected PV power (green) and curtailed PV energy (yellow surface).	59
4.5	Simulation example: Aggregated storage profile at all buses.	60
4.6	Simulation example: Distribution of the storage elements between buses.	61
4.7	Demand side management (blue) and nominal demand (green) at specific bus.	61
4.8	Demand side management aggregated over all loads.	62
4.9	<b>Full operational cost</b> of the grid reference scenario after optimal storage planning <b>without DSM</b> . Low demand (left column) and high demand (right column). Average electricity price of 20 CHF/MWh (top row), 40 CHF/MWh (middle row) and 80 CHF/MWh (bottom row). Results without/with grid upgrade (solid/dashed lines). Results for different battery cost parameters ( $b_{\text{bat}}$ on x-axis, $d_{\text{bat}}$ via different colours).	66
4.10	<b>Total allocated storage size</b> of the grid reference scenario after optimal storage planning <b>without DSM</b> . Low demand (left column) and high demand (right column). Average electricity price of 20 CHF/MWh (top row), 40 CHF/MWh (middle row) and 80 CHF/MWh (bottom row). Results without/with grid upgrade (solid/dashed lines). Results for different battery cost parameters ( $b_{\text{bat}}$ on x-axis, $d_{\text{bat}}$ via different colours).	67
4.11	<b>Total RES curtailment ratio</b> of the grid reference scenario after optimal storage planning <b>without DSM</b> . Low demand (left column) and high demand (right column). Average electricity price of 20 CHF/MWh (top row), 40 CHF/MWh (middle row) and 80 CHF/MWh (bottom row). Results without/with grid upgrade (solid/dashed lines). Results for different battery cost parameters ( $b_{\text{bat}}$ on x-axis, $d_{\text{bat}}$ via different colours).	68
4.12	<b>Full operational cost</b> of the grid reference scenario after optimal storage planning <b>with constant fixed battery costs</b> $d_{\text{bat}}$ . Low demand (left column) and high demand (right column). Average electricity price of 20 CHF/MWh (top row), 40 CHF/MWh (middle row) and 80 CHF/MWh (bottom row). Results without/with grid upgrade (solid/dashed lines). Results for different battery cost parameters ( $b_{\text{bat}}$ on x-axis) and different DSM participation ratios ( $k_{\text{DSM}}$ via different colours).	71

4.13	<b>Total allocated storage size</b> of the grid reference scenario after optimal storage planning <b>with constant fixed battery costs</b> $d_{\text{bat}}$ . Low demand (left column) and high demand (right column). Average electricity price of 20 CHF/MWh (top row), 40 CHF/MWh (middle row) and 80 CHF/MWh (bottom row). Results with/without grid upgrade (solid/dashed lines). Results for different battery cost parameters ( $b_{\text{bat}}$ on x-axis) and different DSM participation ratios ( $k_{\text{DSM}}$ via different colours).	72
4.14	<b>Total RES curtailment ratio</b> of the grid reference scenario after optimal storage planning <b>with constant fixed battery costs</b> $d_{\text{bat}}$ . Low demand (left column) and high demand (right column). Average electricity price of 20 CHF/MWh (top row), 40 CHF/MWh (middle row) and 80 CHF/MWh (bottom row). Results with/without grid upgrade (solid/dashed lines). Results for different battery cost parameters ( $b_{\text{bat}}$ on x-axis) and different DSM participation ratios ( $k_{\text{DSM}}$ via different colours).	73
5.1	Topology of the six bus example system, showing bus numbers and line constraints. The nodes 2-5 are aggregated into the center region. The demand power at node 6 is 4 GW, at all other nodes 3 GW. The maximum generation power at nodes 1 and 4 is 6 GW, at all other nodes 3 GW.	78
5.2	Six bus system with increased transmission capacity aggregated into three regions. Possible net power injections in the center and southern region after dispatch (star). Generator constraints (red), line constraints (yellow) and strong feasibility constraints (green). The intermediate set is convex and lies between the yellow and the green area.	78
5.3	Illustration of the detailed network model with 231 nodes and 439 lines.	79
6.1	Overview of the enhanced representation of the electricity sector in the STEM model	83
6.2	Probabilistic approach for ex-ante determination of requiring positive and negative control reserve capacity [28]	85
6.3	Power plant operating scales for a flexible unit (a) and a non-flexible unit (b) with respect to the electricity generation and reserve provision.	87
6.4	Power-to-hydrogen and power-to-gas pathways	87
6.5	Evolution of electricity storage costs, in terms of energy, for different scales (excluding pumped hydro).	88
7.1	Mapping between the Swiss cantons to the regions identified in the STEM model.	91
7.2	Location of existing power plants (left) and congested transmission grid lines (right) in 2014 (source: VSE [2] and Swissgrid [3])	92
7.3	Domestic electricity production per region in TWh in 2014	93
7.4	A simplified diagram of modelling the electricity grid security constraints as an add-on in the existing structure of STEM; the process is however not iterative	96
7.5	Heuristic to speed up the solution time of the STEM model with electricity grid constraints	97
7.6	Overview of the modelling framework developed in Section 7 and used in the scenario analysis of WP8	98

7.7	Electricity generation mix in 2050, without grid constraints (Case 6) and with grid constraints for different assumptions regarding the locations of large scale gas-based power plants(Cases 1 – 26); the cases are ordered based on the value of the objective function obtained, from the lowest to the highest. . . . .	100
7.8	Objective function (total discounted system cost) for the 26 cases with grid constraints enabled, in which different assumptions regarding the location and the size of large gas power plants are considered; the values are indexed to the objective function of the case without the grid constraints; the vertical line denotes the Case 3, in which it is assumed that the same capacity of gas plants is installed in each one of the 5 sites. . . . .	101
7.9	Long-run marginal cost of electricity supply duration curve in selected cases (vertical axis is limited to -20 Rp./kWh for clarity in the presentation; the actual minimum is -119 Rp./kWh). . . . .	102
8.1	Definition of scenarios . . . . .	107
8.2	Long-run marginal cost of electricity by country of origin from two scenarios: “Reference” is compatible with EU-Trends Reference scenario, while the “Climate Change” scenario assumes 90% CO <sub>2</sub> emission reduction by 2050 from 2010 level in the electricity sector. . . . .	108
8.3	Complete list of the scenarios assessed, including the electricity grid infrastructure expansion variants . . . . .	109
8.4	Final electricity consumption by end use sector for different assumptions regarding the allocation of large gas power plants in P- and W- family of scenarios . . . . .	111
8.5	Electricity generation by technology and electricity final energy consumption in the P-family (top) and W-family (bottom) when no grid expansion is assumed and for Case 3, in TWh. . . . .	113
8.6	Electricity generation by technology in 2050, under different allocation schemes of large gas power plants, in TWh (the results in the corresponding scenarios with imports . . . . .	115
8.7	Regional electricity generation in 2050 (in TWh), for different regional allocation of large gas power plants (Cases 3, 11 and 26) in the P- scenario family; also the regional electricity mix under strong climate policy and high electricity demand (W_CO2) is presented for Case 3 (similar results are obtained for the rest of the cases when strong climate policy and high electricity demand are assumed). . . . .	117
8.8	Electricity storage installed capacity and generation by type for the P- and W- family of scenarios in Case 3, in GWh. . . . .	119
8.9	Charging (negative) and discharging (positive) profile of batteries and CAES in “P-CO2” Case 3 in 2050 (MW), for summer (left) and winter (right) (x-axis represents the typical day in each season and their hourly profile – SUM denotes summer, WIN denotes winter, SA denotes a typical Saturday, SU denotes a typical Sunday and WK denotes a typical working day, while D01-D24 denotes the 24 hours in a day). . . . .	120

8.10	Correlation between electricity trade and pumped hydro storage operation for the “W-CO2-IMP” scenario, Case 3, in 2050 (GW), for summer (left) and winter (right) (x-axis represents the typical day and their hourly profile). . . . .	122
8.11	Requirements in battery storage (aggregated across different sizes) under different assumptions regarding the allocation of the large gas power plants in 2050, in MW . . . . .	122
8.12	Requirements in electricity storage (GW) with respect to the installed capacity of wind and solar across all ISCHESS scenarios, without grid expansion . . . . .	123
8.13	GWh of electricity seasonally stored into Power-to-X technology, for different scenarios (x-axis) and different assumptions regarding the location of the large gas power plants (Cases 3, 11 and 26) in 2050 . . . . .	124
8.14	Installed capacity of electrolyzers, electricity input to electrolysis and electricity entered in electrolysis and it is seasonally shifted in the “W-CO2-IMP” scenario for Case 26, in 2050 . . . . .	124
8.15	Contribution of different options in provision of secondary positive control reserve for Case 3 in 2050, in MW . . . . .	126
8.16	Amount of electricity shifted to different consumption hours via water heaters and heat pumps in 2050 for Case 3, in TWh . . . . .	127
8.17	Undiscounted cumulative cost for the electricity and heat sector in Case 3 scenarios, over the period 2010 – 2050. . . . .	128
8.18	Long run marginal electricity production cost for the “P” and “P-CO2” scenarios for Case 3, with and without the electricity transmission grid constraints; the difference in the marginal costs can be used as a proxy for the congestion rent under restrictions in grid expansion. . . . .	128
8.19	Change in electricity production and final electricity consumption when doubling the most congested line, compared to the grid expansion restriction for Case 3. . .	130
8.20	Electricity generation under different assumptions in the allocation of the large gas power plants when doubling the capacity of the most congested line. . . . .	131
8.21	Changes in installed capacity (in terms of output) of battery storage in the different allocation cases, when doubling the most congested line compared to the grid expansion restriction. . . . .	132
8.22	Change in the maximum contribution in the provision of secondary positive control reserve in Case 3, when doubling the capacity of the most congested line compared to the grid expansion restriction. . . . .	134
8.23	Change in average annual undiscounted system cost over the period of 2020 – 2050, when doubling the capacity of the most congested line compared to the grid expansion restriction . . . . .	135
8.24	Changes in average annual undiscounted cost due to grid expansion per sector, over the period 2020 – 2050 for Case 3 . . . . .	136
8.25	Long run marginal cost of electricity in the “P” and “P-CO2” scenarios with and without grid expansion . . . . .	136



8.26	Electricity generation mix and final consumption in all scenarios and variants of Case 3, under grid expansion restriction, in 2050 . . . . .	141
8.27	Electricity generation mix and final consumption in all scenarios of Case 11, under grid expansion restriction, in 2050 . . . . .	142
8.28	Electricity generation mix and final consumption in all scenarios of Case 26, under grid expansion restriction, in 2050 . . . . .	143
8.29	Installed electricity storage capacity and production in Case 3, under restriction in grid expansion, in 2050 . . . . .	144
8.30	Installed electricity storage capacity and production in Case 11, under restrictions in grid expansion, in 2050 . . . . .	145
8.31	Installed electricity storage capacity and production in Case 26, under restriction in grid expansion, in 2050 . . . . .	146
8.32	Maximum requirement in secondary positive control reserve and maximum contribution per technology in Case 3, under grid expansion restriction, in 2050 . . .	147
8.33	Maximum requirement in secondary positive control reserve and maximum contribution per technology in Case 11, under grid expansion restriction, in 2050 . .	148
8.34	Maximum requirement in secondary positive control reserve and maximum contribution per technology in Case 26, under grid expansion restriction, in 2050 . .	149
8.35	Electricity stored in water heaters and heat pumps in different cases, under grid expansion restriction, in 2050 . . . . .	150
8.36	Electricity stored in Power-to-X pathways in different cases, under grid expansion restriction, in 2050 . . . . .	151
8.37	Cumulative undiscounted system cost over the period of 2010 – 2050 in Case 3, under grid expansion restriction . . . . .	152
8.38	Cumulative undiscounted system cost over the period of 2010 – 2050 in Case 11, under grid expansion restriction . . . . .	153
8.39	Cumulative undiscounted system cost over the period of 2010 – 2050 in Case 26, under grid expansion restriction . . . . .	154
8.40	Electricity generation mix and final consumption in all scenarios and variants of Case 3, under grid expansion, in 2050 . . . . .	156
8.41	Electricity generation mix and final consumption in all scenarios and variants of Case 11, under grid expansion, in 2050 . . . . .	157
8.42	Electricity generation mix and final consumption in all scenarios and variants of Case 26, under grid expansion, in 2050 . . . . .	158
8.43	Changes in the final electricity consumption and generation mix in all scenarios between the grid restriction and grid expansion alternatives for the three different cases regarding the choices in location and size of large gas power plants, in 2050, in TWh . . . . .	159
8.44	Installed electricity storage capacity and production in Case 3, under grid expansion, in 2050 . . . . .	160
8.45	Installed electricity storage capacity and production in Case 11, under grid expansion, in 2050 . . . . .	161

8.46	Installed electricity storage capacity and production in Case 26, under grid expansion, in 2050	162
8.47	Maximum requirement in secondary positive control reserve and maximum contribution per technology in Case 3, under grid expansion, in 2050	163
8.48	Maximum requirement in secondary positive control reserve and maximum contribution per technology in Case 11, under grid expansion, in 2050	164
8.49	Maximum requirement in secondary positive control reserve and maximum contribution per technology in Case 26, under grid expansion, in 2050	165
8.50	Electricity stored in water heaters and heat pumps in different cases, under grid expansion, in 2050	166
8.51	Cumulative undiscounted system cost over the period of 2010 – 2050 in Case 3, under grid expansion	167
8.52	Cumulative undiscounted system cost over the period of 2010 – 2050 in Case 11, under grid expansion	168
8.53	Cumulative undiscounted system cost over the period of 2010 – 2050 in Case 26, under grid expansion	169

## List of Tables

4.1	Parameter ranges sampled for the benchmark simulations of the grid planning procedure. Parameter values for specific illustrations of Section 4.5.1 is set in bold. . . . .	57
4.2	Total operational grid costs $J$ and total curtailment ratio of PV energy $C_{PV}$ for the base scenario using no storages, no DSM and no grid upgrade. Only PV curtailment is used as a fallback strategy when the grid operates at a technical limit. Results for low and high household demand and different electricity prices. . . . .	63
6.1	Costs and efficiency of electrolyzers and hydrogen methanation technologies. . . . .	88
7.1	Electricity consumption by region and sector in GWh, 2014 (colors shades correspond to the region colors of Fig. 7.4.1) . . . . .	92
7.2	Contribution of each location in total (national) installed capacity of large scale gas plants (CC), % . . . . .	99

## Executive Summary

The project *integration of stochastic renewables in the Swiss electricity supply system* (ISCHESS) addresses the problem to be dealt with by network operators due to the integration of large scale stochastic renewable energy sources (RES) in the Swiss electricity systems during the coming decades. Located at the center of the ENTSO-E transmission grid, the Swiss electricity network also forms a benchmark case for the European energy transition. The contributions required for the planning of the future electricity supply system are highly interdisciplinary. This project brings together expertise from economics, technology assessment, life cycle analysis, network security and optimisation. It follows a bottom up approach, first studying the short-term distribution grid aspects; and extending the methods both in temporal and spatial scale to a comprehensive study at the national level.

The first part of the analysis concerns the distribution grid aspects of the future electricity supply. To facilitate the technical solution approaches, a broad review of different strategies for the integration of intermittent RES is performed with respect to their environmental and cost aspects. New inventory data have been established for several battery as well as hydrogen generation technologies. Environmental burdens and potential impacts are quantified using Life Cycle Assessment (LCA) methodology. A time trajectory generator of grid components and a software tool for the operation and planning of electricity grids have been developed and are used throughout the project. The benchmark case is the integration of solar photovoltaic (PV) power in a distribution grid from central Switzerland using grid extension, curtailment, reactive power control, storage units and demand side management. The following findings and conclusion have been made in the first project part:

1. Storage is only economical for higher electricity prices or lower storage costs than today. For low demand scenarios, storage units are only economical for extremely low battery cost. For high demand scenarios with little or no demand side management, storage units can become an economic approach that reduce the curtailment of the solar PV supply.
2. Grid upgrade evaluation depends on the calculation costs of the grid operator. The tool determines the potential gain from the reduced operating costs after a system upgrade.
3. Economically, curtailment is in almost all scenarios reasonable to some extent. The controllability of the PV components models the curtailment of available PV injections that would otherwise overload parts of the network. Costs result from the opportunity costs of not injecting the available PV energy.
4. A strong reduction of the system operating costs can be reached if parts of the nominal load demands can be shifted in time by the distribution system operator (DSO), even if just using 10% of the daily energy demand.
5. Uncertainties related to some of the available LCA, in particular network expansion and some battery technologies are high. The LCA could only be performed on the electricity grid/supply component level, but not on an integrated system level due to time constraints.

The second modelling framework used in this study was the Swiss TIMES energy system model (STEM), which covers Swiss energy system from resource supply to end uses over a long-term horizon. A distinguished feature of the model is its hourly intra-annual time resolution for three typical days (working day, Saturday and Sunday) in four (summer, autumn, winter and spring) seasons. Most importantly, within this project, the electricity sector in STEM has been enhanced by

1. representation of different grid voltage levels with a spatial representation of 15 aggregated nodes;
2. inclusion of new/emerging electricity storage technologies of various sizes for the different grid levels;
3. introduction of variability in wind and solar PV based electricity supply; and
4. representation of secondary (and primary) control reserve provision markets.

In this context, this study contributes with its methodological advancements to the introduction of RES variability as well as grid topology in long term energy systems model. Incorporating grid infrastructure in energy system models provides significant benefits because RES integration can be modelled more realistically, including grid congestion and price effects.

A range of 'what-if' type scenarios was assessed along three main dimensions (namely 1: future energy policy and demand, 2: location of new gas power plants, and 3: electricity network expansion and availability of batteries) to evaluate strategies for integrating stochastic RES in the Swiss electricity and heating sectors. Across the selected scenarios, electricity demands continue to increase and reach over 70 TWh by 2050. At the supply side, up to 3 GW of gas power plants are installed by 2050 to replace the existing nuclear power plants. At the same time, supply from variable renewables sources increases and contributes up to 24 TWh by 2050, under stringent climate policy. This high uptake of variable RES requires pumped hydro storage of about 5.6 TWh (3.3 GW) and batteries of 3.5 TWh (5.3 GW) by 2050. The need for electricity storage increases almost linearly with the deployment of wind and solar PV up to about 14 TWh. However, beyond this threshold of wind and solar PV based electricity generation, an accelerated deployment of storage is inevitable. In this context, batteries offer distributed (localized) balancing solutions, with their deployment potential depending on the grid level to which they are connected. The uptake of battery storage is driven by solar PV (at low voltage levels), and wind and CHP (at medium voltage levels). At the same time, large-scale batteries complement pump-hydro at high voltage levels when the latter is only partially available due to water resource restrictions or participate in other markets (e.g. balancing markets or international trade). In 2050, up to about 13% of the summer electricity production from wind and solar PV is stored for consumption in autumn and winter seasons. In conditions where stringent climate policy and restriction of grid enforcement are applied, power-to-gas technologies represent one option for seasonal energy storage driven by differences in seasonal electricity production costs. On the demand side, dispatchable loads such as water heaters and heat pumps, contribute in easing the electricity peak by shifting 10–25% of the electricity demand on a daily basis.

The analysis indicates that if there were to be no further grid expansion other than planned for 2025, grid congestions, the operation of certain network elements close to the loading limit, would become a major bottleneck to cope with increasing electricity demands. For example, under stringent climate change mitigation policy congestion could occur up to 7000 hours in the year 2050. Importantly, congestion affects both the electricity supply and demands. At the supply side, it could lead to the deployment of non-cost effective options in some grid nodes, such as geothermal for base load electricity, if full dispatchability of some more cost effective options in other grid nodes, such as large gas power plants, cannot be achieved due to congestion. It can also hinder the penetration of renewable electricity. On the demand side, grid congestion limits the electrification and retains fossil-based heating supply, compared to a reversed trend when the grid is expanded.

In fact, when grid infrastructure is to be reinforced, the overall net economic benefits for the Swiss electricity and heat system outweigh the costs of expansion. In this case, congestion levels reduce to less than 3000 hours (43% lower than the no grid expansion scenario). The savings in the whole electricity and heat supply system of Switzerland are in the range of 0.5 – 3 billion CHF per year over the period of 2020 – 2050 depending on the scenario. These cost savings result from changes in the electricity supply side (35% of the total cost savings on average), reduced imported electricity and fossil fuels (38%) and structural changes in the heat supply (27%).

Both electricity storage and grid expansion are necessary to realise the full potential of variable renewable energy sources. When both storage and grid expansion are excluded, then 20 – 50% less solar PV and wind are deployed, but the contribution from gas based generation increases up to 45%. The latter results in higher CO<sub>2</sub> emissions and consequently, incurs additional climate change mitigation costs up to 6 billion CHF per year (or +17%) on average over the period 2020 – 2050, compared to the case where both options are enabled.

# 1 Project Overview

## 1.1 Project Scope

The recent past has seen an increase in energy and climate policies oriented towards the promotion of renewable energy sources (RES) such as wind and solar. These RES feature a number of advantages as energy generating options: they are inexhaustible, have a low carbon footprint and can operate on a small scale, enabling their usage in the distribution grid. They are however typically variable and volatile, producing alternating and partly unpredictable amounts of electricity over time.

Since electricity grids have historically required generation to match consumption on a second-by-second basis, the future electricity system will have difficulties in meeting this fundamental stability requirement. Renewables will challenge the traditional way of continuously matching supply and demand and peak production of intermittent renewable sources feeding into the low-voltage grid could foster the need for specific measures at this level. The increasing role of such RES within the electricity network has therefore raised concerns about grid reliability and security of supply, and prompts the need for appropriate solutions depending on what the penetration level and impact of RES might be.

The project goal is to study the integration measures required for increasing the penetration level of distributed stochastic generation in the Swiss electrical supply system. The first phase will focus on evaluating the impact of intermittent RES at the distribution voltage level, whereas the second phase will extend the study to the national scale of the transmission grid. More specifically, at the distribution level there exist a variety of alternatives for the integration of RES in the grid.

- One alternative consists in reinforcing and expanding the network as required by the increasing energy flows in the grid. Conceptually, this is the traditional way to accommodate for varying power levels in the network and can therefore be denoted as business as usual (BAU).
- A novel option consists in the employment of batteries: in a bidirectional and less predictable system that nevertheless needs balancing, electrical storage devices in the distribution grid could balance supply and demand, since they offer the potential to store generated (excess) electrical energy and release it at a later point in time when there is a shortage of energy supply.
- Dispatchable loads (such as electrolyzers for hydrogen production or water heaters) represent an additional alternative in that they offer the possibility to shift the electricity demand in time, so that the generation/load balance may be temporarily preserved.
- Lastly, one further option is to directly curtail RES generation when too much generated energy is available, in order to preserve the energy equilibrium in the grid.



Figure 1.1: Project Work Plan



## 1.2 Project Workplan

The ongoing workplan development has started first with brainstorming workshops identifying goals, framework, data sources and corresponding functions and second characterising resulting interfaces between groups.

For the visualisation of the work flow, data flow and interfaces, the graphical representation depicted in Fig. 1.2 will be used. The figure shows the required data to perform a task and the results of the task with a corresponding color map which is indicating the task share between the project partners (see Fig. 1.3).

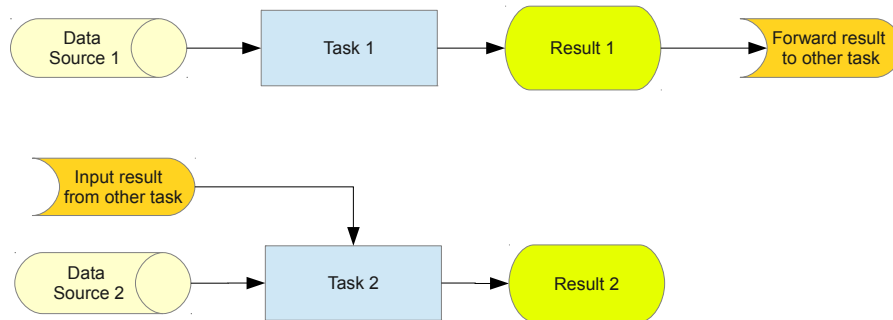

Figure 1.2: Graphical representation of work flow, data flow and interfaces

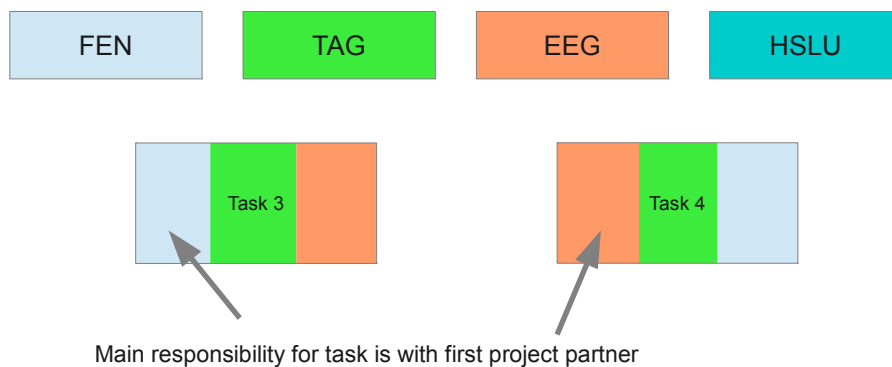
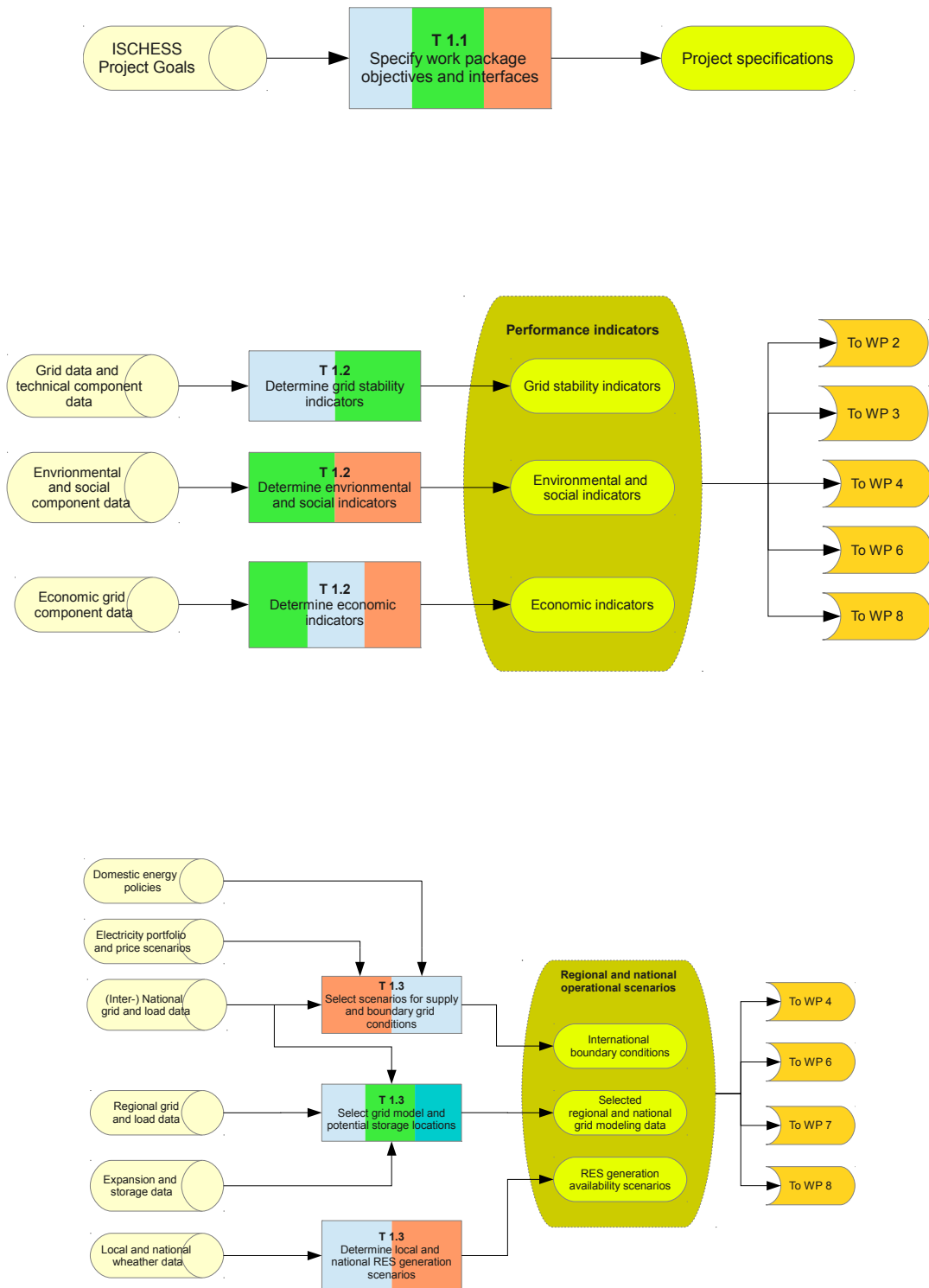

Figure 1.3: Color Map for task sharing

The result of the work flow, data flow and the interfaces analysis per workpackage is depicted below.

## WP1: Definition of objectives, indicators, scenarios



## WP2: Technology assessment

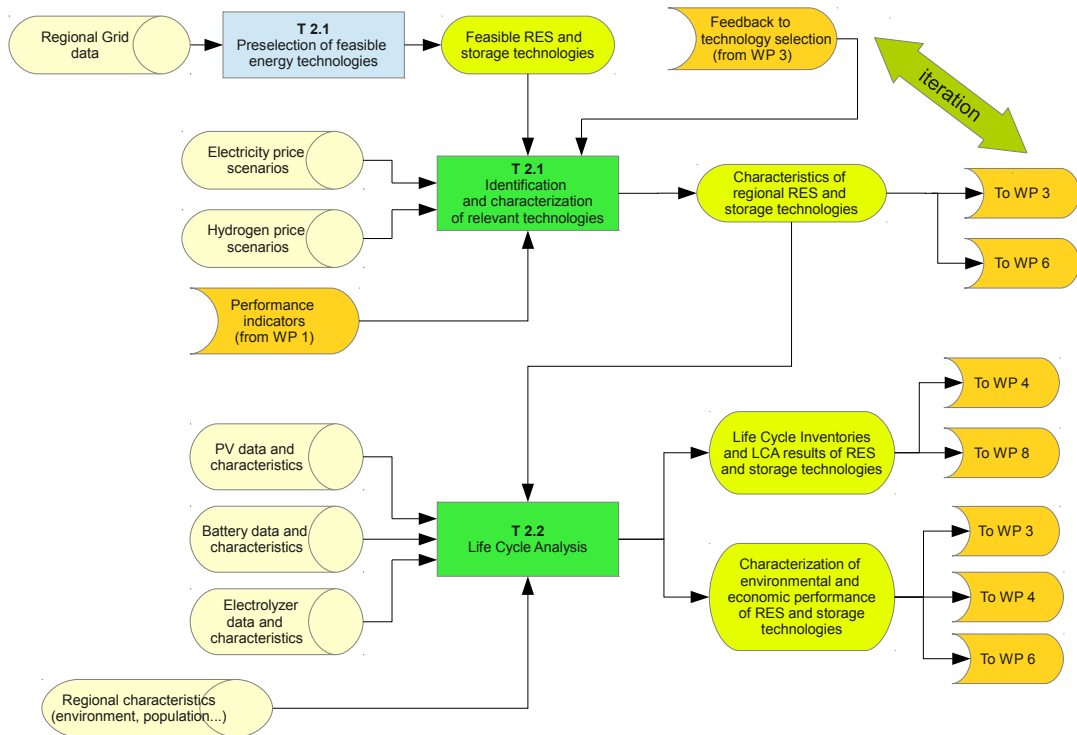

## WP3: Distribution grid modeling

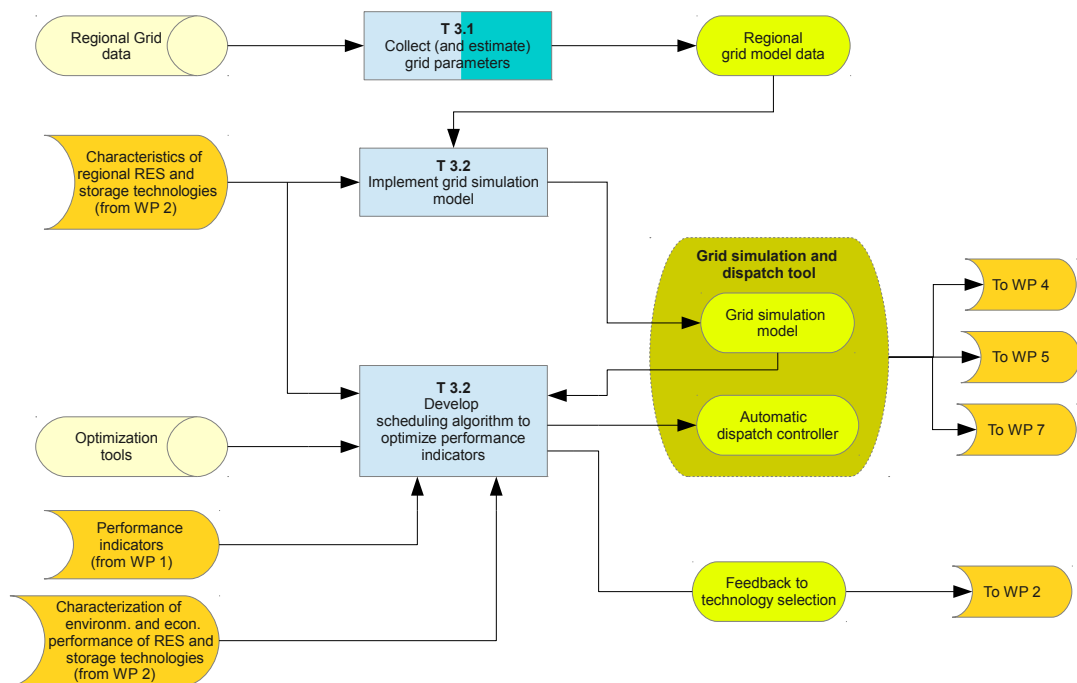

## WP4: Assessment of alternative RES integration strategies

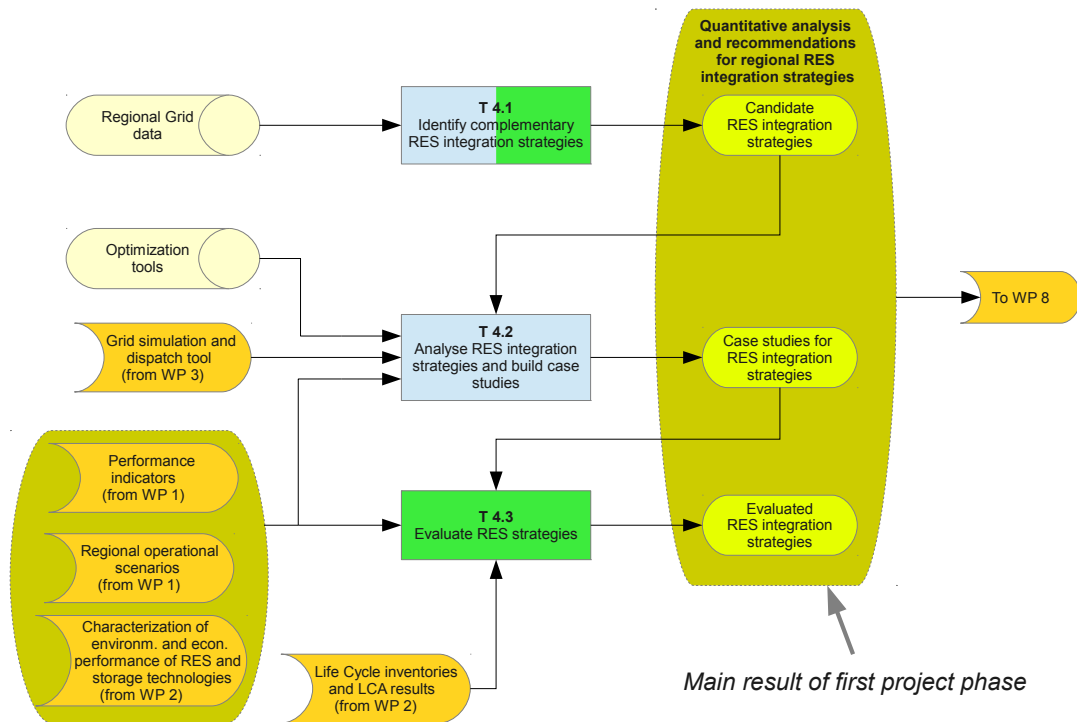

## WP5: National electricity grid modeling

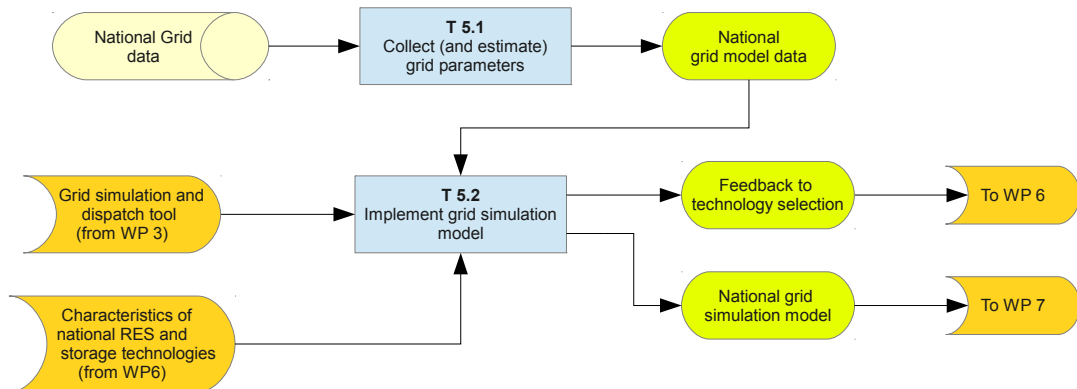

## WP6: Energy system modeling

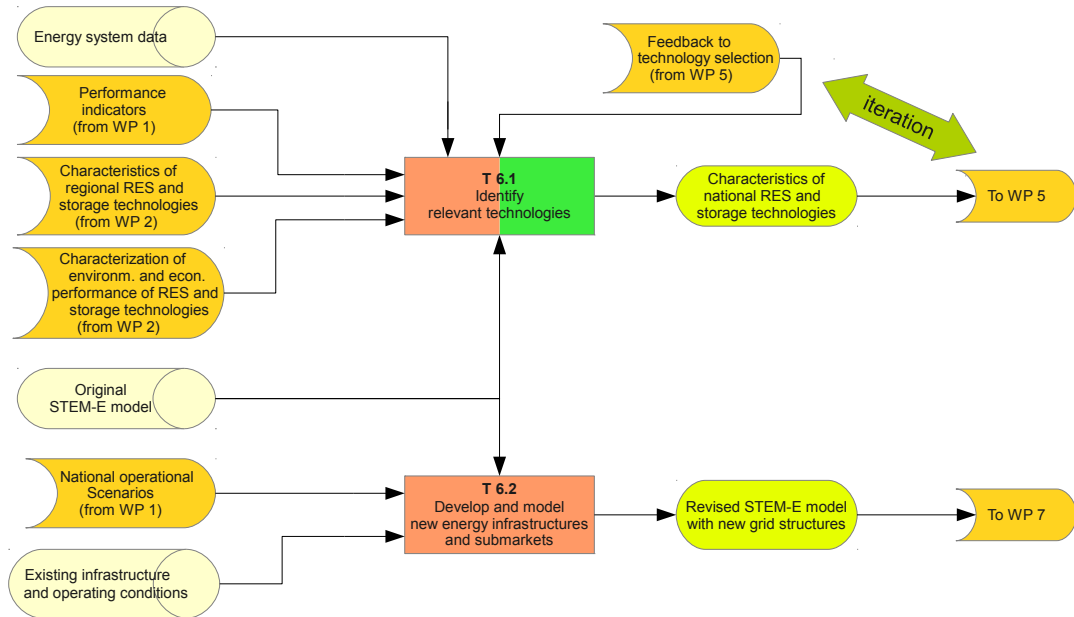

## WP7: Integration of energy system and grid modeling

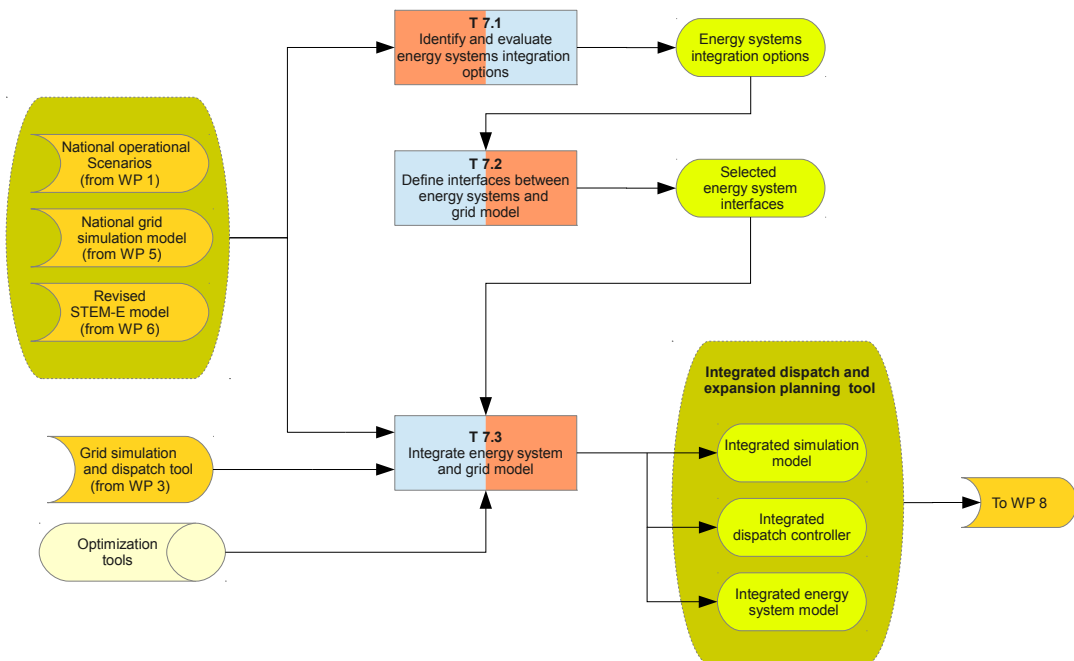

## WP8: Assessment of different future energy scenarios

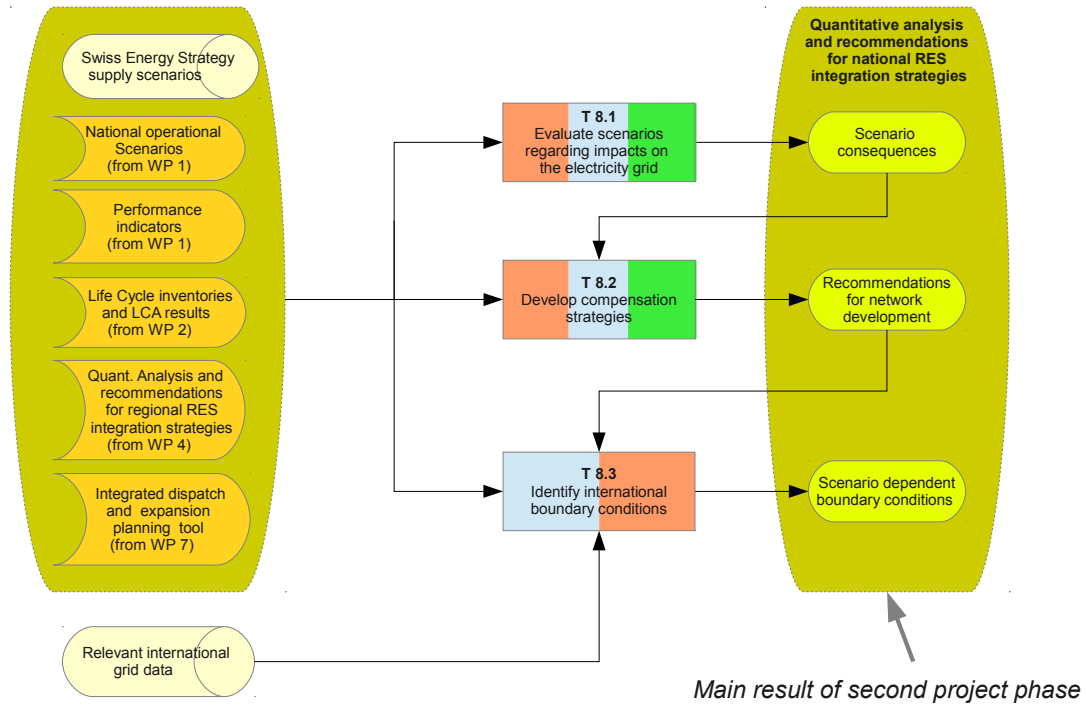

## WP9: Project management

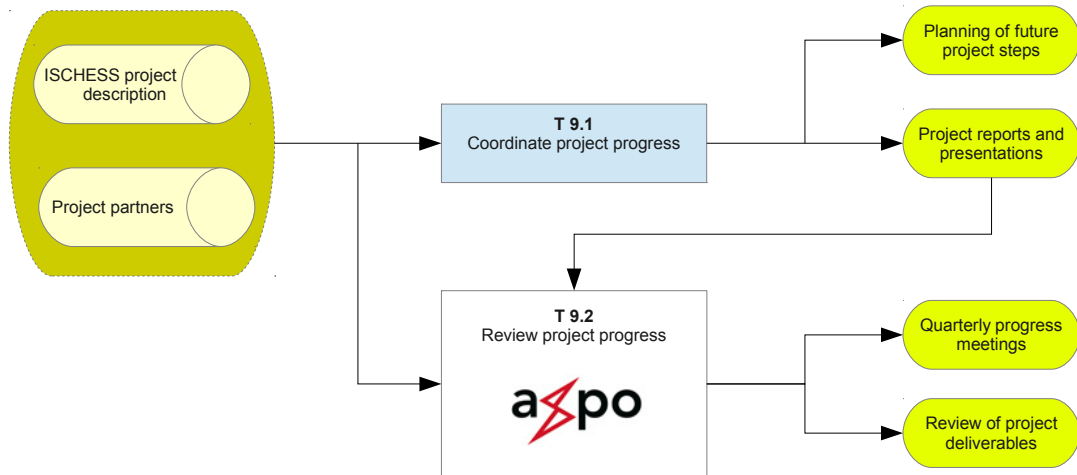

# Deliverables summary with main responsible project partners

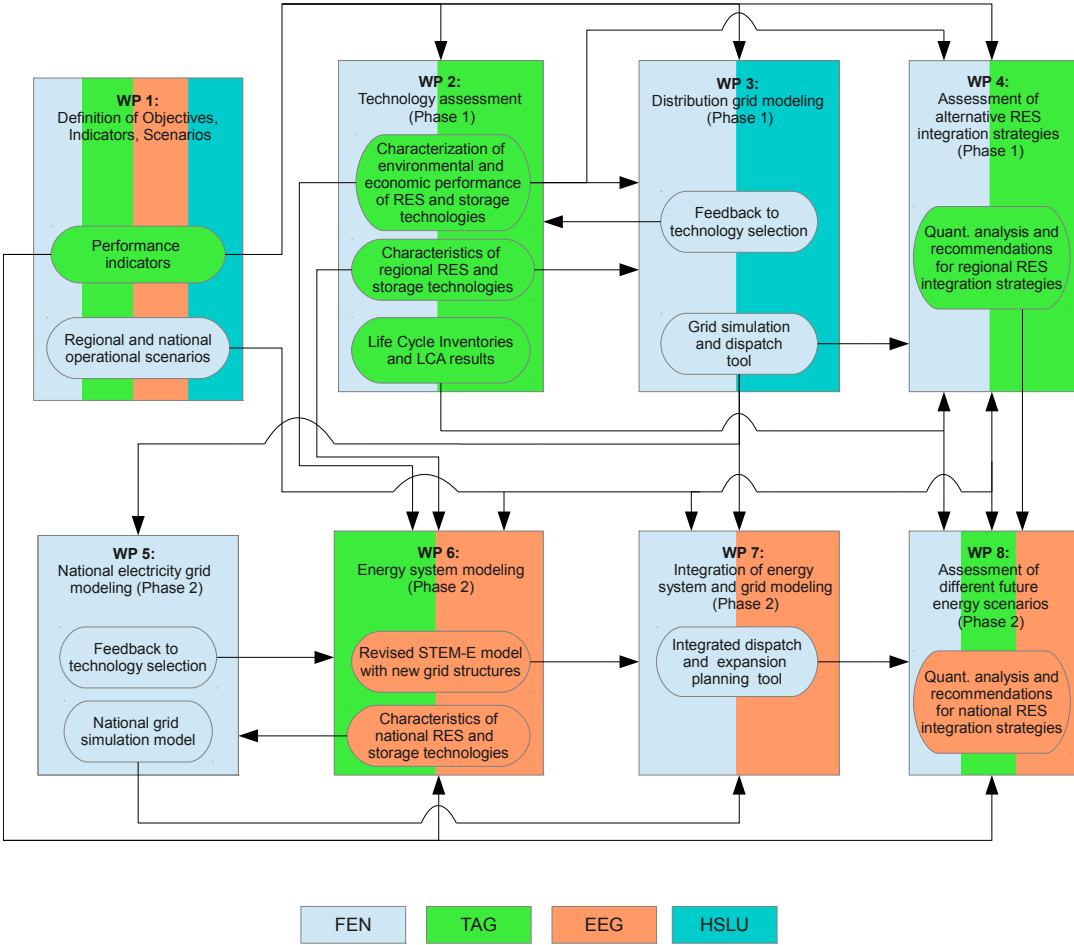

## **2 WP2: Technology Assessment**

### **2.1 Introduction**

The evaluation of different strategies for integration of intermittent renewable electricity (RE) generation in the Swiss power supply system carried out in this project includes both environmental and cost aspects. Environmental burdens and potential impacts are quantified using Life Cycle Assessment (LCA) methodology. Economic costs are quantified using the Life Cycle Cost (LCC) methodology for technologies, which are then incorporated into the scenario analysis based on system operation.

### **2.2 Objectives**

#### **2.2.1 Life Cycle Assessment (LCA)**

Including LCA into the comparative evaluation of different integration strategies for renewable electricity generation – both on the regional and the national level – aims at the quantification of environmental benefits and drawbacks of these different strategies.

#### **2.2.2 Life Cycle Cost (LCC)**

Life cycle cost is based on the levelized cost methodology, which is used to compare the relative costs of different integration strategies for renewable electricity generation – both on the regional and the national level. These technology level costs are also used for economically optimizing the various strategies analyzed.

### **2.3 Scope**

#### **2.3.1 Life Cycle Assessment (LCA)**

The scope of the LCA includes all technologies and components, which are part of the regional and national generation and supply scenarios, respectively. Electricity generation from intermittent technologies such as photovoltaics and wind power are considered as well as alternative supply from the average Swiss supply mix; different battery technologies for electricity storage are taken into account; furthermore, hydrogen generation using “excess electricity” from wind and PV power plants is included as flexible demand measure; and finally, grid reinforcement is considered in terms of additional power lines and transformer stations.

#### **2.3.2 Life Cycle Cost (LCC)**

The scope of the LCC analysis performed within WP2 included the costs of all the technical options initially considered for the regional distribution network analysis, including storage (e.g. different battery technologies) and dispatchable loads (primarily hydrogen from electrolysis). Costs for distribution grid expansion were collected by FEN from industry partners, and costs for curtailment of stochastic generation were considered to be negligible. These options were extended by



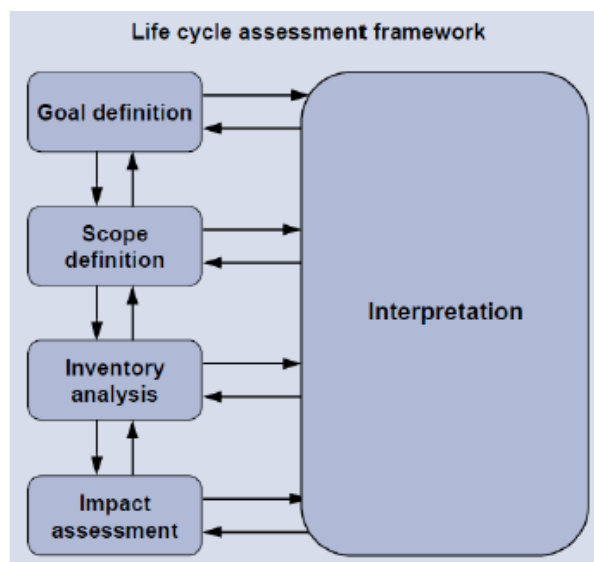

Figure 2.1: LCA scheme – framework for Life Cycle Assessment [3] arrows in both directions indicate iterative processes.

additional technologies for the national transmission grid study, including further storage options (e.g. larger scale batteries and compressed air energy storage).

## 2.4 Methodology

### 2.4.1 Life Cycle Assessment (LCA)

**Introduction** Life Cycle Assessment is used to quantify environmental burdens along complete value chains and life cycles of products and services. Production and use phase as well as end-of-life of products are taken into account. Emissions into air, soil and water bodies as well as resource extractions and land use are quantified. LCA methodology is described in detail in [1], [2], a scheme representing the LCA framework is shown in Figure 2.1. The first step, goal and scope definition, is followed by compilation of Life Cycle Inventory (LCI) data for each process in the analyzed product system (“unit process”). These unit processes are linked in a way allowing for quantification of total environmental burdens per functional unit of a product or service. Based on these burdens and using so-called “Life Cycle Impact Assessment” (LCIA) methods, potential impacts on resource quality, ecosystem quality and human health can be quantified.

The LCA carried out in this project is attributional and process-based. I.e., it is based on average material and energy supply chains (as opposed to marginal suppliers) [4] [5] [6] and environmental exchanges are recorded on a process level (as opposed to using environmentally extended, economic input/output tables) [7] [8] LCA is performed using the LCA software SimaPro [9] and ecoinvent background life cycle inventory (LCI) data [10]. LCIA methods/indicators applied are:

- Cumulative Greenhouse Gas (GHG) emissions (GWP 100a) according to IPCC 2007 [11].
- Impacts on Human Health (HH) according to ReCiPe (H,A)<sup>1</sup> [12].

<sup>1</sup>H: cultural perspective “Hierarchist”; A: “Average” weighting.

- Impacts on Ecosystem Quality (EQ) according to ReCiPe (H,A) [12].

The approach used for quantification of environmental burdens associated with the different RE integration strategies consists of several steps:

- a) Selection and specification of all relevant (potential) components of the electricity supply system: specific power generation technologies; electricity supply mix from the Swiss grid; batteries for electricity storage; power lines and transformers for grid infrastructure extension; hydrogen generation via electrolysis as flexible load.
- b) Compilation/collection of process based LCI data of all (potential) components of the electricity supply system; alternatively, use of appropriate LCI data from previous work or the ecoinvent background database.
- c) Quantification of cradle-to-gate<sup>2</sup> LCIA indicators for the components of the electricity supply system.
- d) Use of these component-specific LCIA indicators in the electricity network models, either as optimization objective (life-cycle GHG emissions), or for “post-modeling” processing (impacts on human health and ecosystem quality).

RE integration strategies are evaluated on the system level (as opposed to technology level), i.e., including all applicable (scenario-dependent) supply, demand, and storage technologies, network components and hydrogen production. Hydrogen from electrolysis (as flexible load) is considered as substitution of conventional production via steam methane reforming (SMR) of natural gas according to (Simons and Bauer 2011). Curtailed electricity generation is assumed to be alternatively provided from the average Swiss supply mix according to the ecoinvent database [10]. Evaluation on the system level means that total environmental burdens (GHG emissions, impacts on HH, and EQ, respectively) are quantified for each scenario (i.e., for each RE integration strategy) for a given year and these scenario results can be compared.

**LCA data:** Primary LCI data have been collected for lead-acid, current and future Li-Ion and vanadium redox-flow batteries (the two latter are used on the national level) as well as for hydrogen generation via electrolysis. The detailed LCI data for these technologies are documented in associated publications (REFs). This report provides their technologic specification as well as some key performance indicators. LCI data from previous or parallel projects or from the ecoinvent background database have been used for all other technologies. This project also includes evaluation of future scenarios on the national level. Ideally, LCI data representing future technologies would be used. However, compiling specific LCI data for all future technologies to be used within scenario evaluation, including background LCI data, is out of scope given the available resources. Only some of the LCI data are adjusted in order to represent expected technology development until 2050; these adjustments will be based on the expected improvement of technology-specific key performance indicators such as battery lifetime, electrolyzer and battery efficiency, etc.

---

<sup>2</sup>The term “cradle-to-gate” refers to production related environmental burdens of products. I.e., use and end-of-life phases are not included.

## Batteries

- Lead-acid battery (current; application in the regional scenario): LCI data of the lead-acid battery are largely based on [13] and are reported in (Bielitz 2016). Production and manufacturing of the battery is assumed to take place in Europe. The energy density of the battery amounts to 92 Wh/l and the specific energy is 35 Wh/kg [13].
- Li-Ion battery (current; application in the regional scenario): LCI data for current Li-Ion batteries were compiled by [14], represent automobile applications and are used as implemented in [10]. The technology used here is a spinel type  $\text{LiMn}_2\text{O}_4$ /graphite (cathode/anode) battery with a specific energy of 114 Wh/kg.
- Li-Ion battery (future; application in the national scenario): Li-Ion batteries are expected to be specifically designed for stationary applications in the future in order to allow for an extended lifetime and enhanced safety at the expense of reduced specific energy content. Primary industry data representing a new product from Leclanché were collected for this study; the resulting LCI data are documented in [15]. The battery is based on lithium titanate oxide ( $\text{Li}_4\text{Ti}_5\text{O}_{12}$  or LTO) anodes and lithium nickel cobalt aluminum oxide ( $\text{LiNiCoAlO}_2$  or NCA) cathodes. According to the manufacturer and independent verification, the NCA/LTO battery is particularly suited for large-scale storage applications due to the extremely long cycle life of up to 15'000 cycles, inherent safety and little capacity degradation even under high discharge (Pettinger 2014). The specific energy on the cell level amounts to 70 Wh/kg, on the battery module level to 42.4 Wh/kg [15].
- Vanadium Redox-Flow Battery (VRFB) (future; application in the national scenario): Contrary to conventional batteries, the electrochemically active elements of redox-flow batteries are not partly solids at the electrodes within the battery cell. Instead, they are completely dissolved in fluids stored outside of the actual battery and circulated through the cell by external pumps whenever needed. A major advantage of this layout is the flexibility of design by independently sizing power and energy. Power scales with the active surface area of the membranes and electrodes inside the cell, while the energy capacity is a function of electrolyte volume. Virtually unlimited energy capacity can be achieved by simply increasing the amount of electrolyte and the size of the storage tanks, which makes RFBs perfectly suitable for large-scale, stationary energy storage. The main disadvantage, low energy and power density compared to other electrochemical storage systems, is thus irrelevant for the targeted application [15]. Primary industry data are collected for compiling the LCI data of a VRFB for this study. The "Cell-Cube" from Gildemeister GmbH serves as commercial reference technology. One of the products offered is the "FB 200-400" with a power output of 200 kW and an energy storage capacity of 400 kWh, which is selected as reference technology within this study (other options are units with 800 and 1600 kWh storage capacity at 200 kW power; also units with smaller power and energy storage capacities exist). Complete LCI data are documented in [15]. The manufacturer claims a virtually unlimited cycle life for the battery, if maintenance is regularly performed. The only components that have to be replaced every 10 years are the pumps and the stacks. Specific energy of the "FB 200-400" amounts to 14 Wh/kg.

**Expansion of the electricity grid** Configuration and layout of grid expansion is relatively case-specific. Given the boundary conditions of this project (i.e., no specific project for reinforcement and expansion of power lines, but generic “expansion” of the grid infrastructure), generic LCI data for additional power lines and transformer stations from the ecoinvent database are used (ecoinvent 2014).

**Hydrogen generation – flexible load** Hydrogen production via electrolysis acts as flexible load in this project, meaning that electricity generated by RE and not consumed elsewhere can be converted via electrolysis to hydrogen. The hydrogen is assumed to be sold on the market, i.e. substitute conventional production via steam methane reforming (SMR) of natural gas.

- As flexible load via electrolysis: Primary data for electrolysis with alkaline and PEM electrolyzers have been collected. Complete LCI data are documented in [16].
- Alternative hydrogen production: LCI data from [17] are used for conventional hydrogen production via SMR of natural gas.

**Photovoltaic (PV) power generation** LCI data from the ecoinvent database representing Swiss average annual yield and multi-crystalline Si-modules mounted on slanted roofs are used for photovoltaic power generation [18], [10]. Both PV technologies and annual production can easily be adjusted according to location-specific insulation and yield, if more specific data are available.

**Wind power generation** LCI data from the ecoinvent database representing average annual Swiss yield and wind turbines with capacities of 1-3 MW are used for wind power generation [18],[10]. Both turbine technologies and annual production can easily be adjusted according to location-specific wind conditions and yield, if more specific data are available.

**Electricity supply from the grid** LCI data from the ecoinvent database representing the average Swiss electricity supply mix at high, medium, or low voltage level (HV, MV, LV) are used for electricity from the grid [18], [10]. This mix represents an annual average of domestic production and electricity imports. This mix is used in case of curtailment, i.e. substituting the RE generation not used, and for electricity imports in the regional case scenario.

**Background LCI data** Background LCI data from ecoinvent (ecoinvent 2014) are used for compilation of new process LCI data within this study.

## 2.4.2 Life Cycle Cost (LCC)

**Introduction** Life Cycle Cost is used to quantify economic impacts of the technologies considered. Unlike LCA, market costs automatically include internal costs of upstream activities, e.g. fuel costs automatically include fuel extraction (mining, drilling), refining and transport. Unlike LCA that quantifies downstream burdens, the life cycle cost does not include external costs not born by the end customer (e.g. environmental damages born by 3<sup>rd</sup> parties).

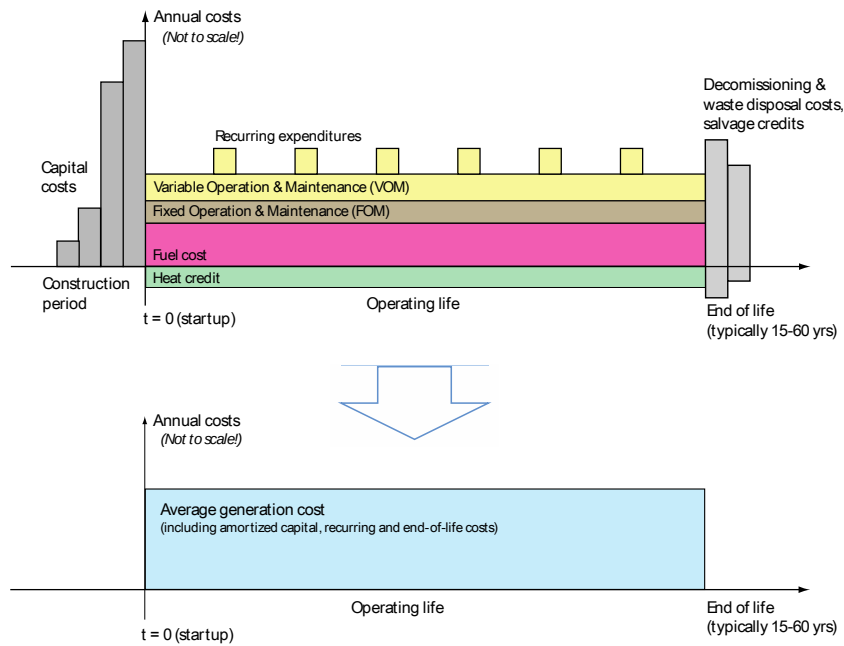

Figure 2.2: LCC levelized cost methodology

The basic methodology used in the life cycle costing is the levelized average cost of energy. In this approach, initial capital costs (including any interest) and end-of-life costs or recycling credits are amortized over the life of the technology, and added to the fuel/energy costs, non-fuel operating costs and maintenance. Total annual costs are divided by expected annual generation to obtain the levelized average cost of energy. This approach is illustrated in Figure 2.2 below.

For the economic analysis of the storage technologies considered this methodology deserves some particular comments.

First, the capital costs for storage technologies include both power and energy related costs, although these are not always, or even generally, clearly separated in the literature. In general, the battery represents the energy cost, and the power conversion and control equipment are power related costs. In the VRFB battery, the energy cost is linked to the electrolyte tank size. In compressed air energy storage, energy costs are based on cavern or tank size, and the power costs are linked to the size of the motor/compressor and the turbine/generator (these may be the same or separate). The average cost depends on combined energy and power costs, which in turn depends on the average cycle duration, which is key for both cost and storage technology choice.

Second, battery lifetime varies between technologies, but generally is determined by a complex combination of different damage mechanisms that depend on the both state of charge, the rate of charge/discharge, time, cycle count, temperature, etc. The end result is that the initial cost of the battery is not considered to be a fixed cost incurred once, but rather a marginal cost. That is, since the battery life depends upon its use, it is expensed based on the initial cost of the storage divided by the total lifetime energy throughput (in and out of the storage system). The lifetime energy throughput depends on the (interdependent) factors of discharge depth and cycle lifetime.

Third, both batteries and electrolyzers have significant economies of scale, so that the average cost declines with increasing size, and this is true for both the energy and power components of the capital costs.

The approach used for surveying the economic costs associated with the different renewable energy integration strategies consists of several steps:

- a) Selection of all potentially relevant components of the electricity supply system. In the case of costs this specifically means costs for the four major technical alternatives, i.e. electricity storage, additional grid infrastructure, dispatchable loads, and renewable energy curtailment. While a relatively limited set of technical alternatives within these categories was selected for the Phase 1 study on the distribution level, the set was expanded to also include larger technologies for the Phase 2 study of the national transmission grid.
- b) Collection of LCC cost data for all the technologies identified above. While investing in the assumed renewable energy generation capacity (that requires these technological alternatives) is certainly not inexpensive, the amount of capacity (and thus cost) is assumed to be equal in all the scenarios analyzed, and so the cost analysis focuses on the scenario elements that differ. Of these, the primary focus of the cost data collection was on the electricity storage and dispatchable load alternatives. Cost data on increased transmission and distribution capacity was gathered directly by FEN due to their close cooperation with the utility partners. Costs for curtailment of renewable generation were neglected, as the marginal costs for remote control are extremely small compared to the increased generation costs from other sources required to meet system load.
- c) In general, the battery and electrolysis data sources vary significantly in their own breadth or comprehensiveness, date of sources, assumptions, and overall quality. Rather than a strict algorithm approach to ‘average’ the results, the results were more qualitatively assessed for ‘consensus’ value, weighted by expert judgment regarding their relative reliability. Where appropriate, LCC data gathered was backstopped or compared to cost data available from previous project work performed within LEA.
- d) Cost data were supplied to FEN as needed to meet the Phase 1 and 2 modeling requirements (e.g. battery degradation costs).
- e) Unlike the LCA indicators, cost indicators were used directly by FEN and reported in their modeling results, without any need for post-model processing.

As mentioned above for both LCA and LCC, the renewable energy integration strategies are evaluated on the system level (as opposed to technology level), i.e., including all applicable transmission, storage, demand, and replacement energy costs. The necessary energy replacement costs for the renewable curtailment case in Phase 1 were assumed to the same spot market energy prices that were also used for the storage scheduling optimization. For Phase 2, the curtailed energy costs were based on the marginal replacement power costs from the existing capacity mix. Where hydrogen electrolysis was considered as a dispatchable load, the resulting hydrogen was given a value that was based on typical Swiss hydrogen costs for the transportation market, minus the transportation cost to the final fueling station.

Again, evaluation on the system level means that total costs are quantified for each scenario (i.e., for each renewable energy integration strategy) for a given year and these scenario results

can be compared to each other and also consistently compared against their relative environmental burdens.

**LCC data** Primary LCC data have been collected for lead-acid, current and future Li-Ion and vanadium redox-flow batteries (the two latter are used on the national level) as well as for hydrogen generation via electrolysis. The detailed LCC data as well as technical characteristics (size, efficiency, life, etc.) for these technologies are documented in results table, which also give a listing of references for each technological alternative.

**Batteries** The survey of battery costs reveals, in general, a very broad range of costs both within each battery type, as well as between the different battery types. The average cost and choice of battery depends upon the intended duty cycle (4 hours of storage for the Phase 2 study), and the broad cost ranges for different types overlap so a choice is not generally clear based on cost alone. The battery survey also revealed a general incoherence or inconsistency by many sources in giving a clear split between energy and power costs, or the basis for average storage cost.

- Lead-acid battery (current; application in the regional scenario): Although lead-acid batteries suffer from a relatively poor energy density (by weight) that makes them poorly suited for vehicle applications, this is not a significant problem for stationary applications. In general, their relatively low cost is counter balanced by their relatively short life, some specific models are cost competitive in specific applications, and there are still technological advances being made to reduce degradation, increase life, and reduce costs.
- Li-Ion battery (current; application in the regional scenario): Although lithium ion battery technology is largely driven by the market for mobile applications (vehicles and consumer electronics), they are now increasingly of interest for stationary applications. They are characterized by relatively higher costs, longer lives, and higher cycle efficiency.
- Li-Ion battery (future; application in the national scenario): The lithium ion cost results for the Phase 2 national scenario were based on a survey of a range of lithium ion chemistries, rather than the specific lithium titanate oxide chemistry used for the LCA analysis. In particular, a lower lifetime of 4000 cycles was assumed for the cost analysis (instead of 15000 for the LCA analysis).
- Vanadium Redox-Flow Battery (VRFB): As noted above, the redox-flow battery stores its energy in the rather viscous fluid electrolyte, rather than in solid electrodes, and so the energy storage is determined by the size of its tanks. The power to energy ratio is therefore more flexible than usual for other batteries (although for Phase 2 a common duty cycle of 4 hours of storage was used). The typical low energy density by weight or volume for the VRFB is not a significant problem for this stationary application.
- The sodium sulfur battery is a high temperature battery technology that is better suited for large, utility-scale applications. The technology has a medium assumed life of 3500 cycles, and a slightly longer duty cycle of 6 hours of storage.

- **Compressed Air Energy Storage (CAES):** For Phase 2, compressed air energy storage was chosen as a large-scale electricity storage option. This technology only has two existing, operating plants, but is widely studied as a potential future option that has a broader siting potential than pumped hydro. PSI is currently part of a research project that is studying an advanced adiabatic compressed air storage technology (AA-CAES) that has a higher potential cycle storage efficiency of 70%, by storing and then recovering the heat of compression. However the CAES options considered for the current work use the more conventional technology where the heat of compression is not stored, but the expanding air is used with natural gas to drive a combustion turbine.

**Expansion of the electricity grid** As noted above, distribution and transmission grid expansion costs were collected by FEN from industry partners and other sources, and were not collected within Work Package 2.

**Hydrogen generation – flexible load** It was assumed for the initial phase one analysis that the electrolysis unit would be located at the point where the local distribution grid connected to the higher voltage transmission grid. This was for two reasons. First, the relatively large economies of scale mean that the electrolysis costs are much lower for a larger, central unit. Second, it was assumed that the hydrogen generated would be sold for vehicle use, which is much more reasonable from a large, central unit than from small, distributed units. The value of the hydrogen was based on Swiss industry estimates for sale to vehicle transport, minus the hydrogen transport cost to the final point of sale. However, it became clear later in the analysis that if the electrolyzer is located in this way, there is no reason to limit its energy use to the electricity generated from the renewable resources in the distribution grid below it. Instead the electrolyzer can purchase any amount of power at any time from the higher voltage grid, based only on the hourly cost. In this case the economic analysis becomes a question of balance between the unit size, its economies of scale, and the capacity factor based on marginal cost, efficiency and hourly electricity prices. None of this is related to the local distribution grid constraints or stochastic generation, and so makes this option much more significant for the second phase national grid analysis than for the initial phase distribution grid analysis.

**Renewable generation (PV and wind) and grid electricity costs** Renewable generation is non-dispatchable, and therefore the timing and value of this generation are fixed between the various scenarios considered. As noted above, the capital cost of the renewable generation is also fixed between the various scenarios. The WP2 analysis therefore focused on the LCC costs of the storage and dispatchable load technologies considered. The grid electricity costs were considered to be exogenous in the first phase distribution grid, and were based on the national generation mix within the system-wide modeling performed during the second phase. From the technology assessment level, these costs are reflected by specifying the storage and electrolysis efficiencies so that energy losses are included. From the system assessment level, the grid electricity costs are also used to find the loss of revenue when the renewable generation curtailment alternative is analyzed.



		Batteries				Hydrogen		
		Lead-acid battery	Li-Ion batter, current	Li-Ion batter, future	Cell Cube 200-400	H2, electrolysis, alkaline, PV supply	H2, electrolysis, PEM, PV supply	H2, SMR
	unit	kWh storage capacity	kWh storage capacity	kWh storage capacity	kWh storage capacity	MJ H2 (LHV)	MJ H2 (LHV)	MJ H2 (LHV)
GWP 100a	kg CO2 eq	125	69	671	251	0.047	0.040	0.135
Human Health	DALY	2.12E-04	4.49E-04	7.29E-04	1.17E-03	1.57E-07	1.29E-07	2.23E-07
Ecosystem quality	species.yr	3.32E-07	6.66E-07	1.67E-06	2.40E-06	4.52E-10	3.87E-10	1.12E-09

Figure 2.3: LCA results of batteries and hydrogen production; per kWh of storage capacity for batteries and per MJHLV of hydrogen, respectively

		electricity				
		electricity, PV	electricity, wind	electricity, supply mix, HV	electricity, supply mix, MV	electricity, supply mix, LV
	unit	kWh generated	kWh generated	kWh supplied	kWh supplied	kWh supplied
GWP 100a	kg CO2 eq	0.081	0.018	0.116	0.115	0.123
Human Health	DALY	7.20E-08	1.71E-08	7.06E-08	7.13E-08	8.21E-08
Ecosystem quality	species.yr	2.17E-10	5.61E-11	3.02E-10	3.00E-10	3.24E-10

Figure 2.4: LCA results of electricity production and supply mixes in Switzerland; per kWh of electricity generated at PV modules and wind turbines, respectively, and per kWh supplied from the grid.

## 2.5 Results

### 2.5.1 LCA results on the technology level

LCA results on the technology level (i.e., cradle-to-gate) are provided per component. Different functional units cannot be avoided, which makes a comparison of these results somewhat meaningless. Even if cradle-to-gate LCA results can be compared, e.g. for different battery technologies, the life-cycle burdens will depend on performance indicators such as round-trip efficiencies, lifetimes, etc. and the application scenarios.

Results are provided for the three selected LCIA indicators: impacts on climate change (expressed in cumulative GHG emissions) and impacts on human health (HH) and ecosystem quality (EQ). Impacts on climate change (GWP 100a) per scenario component are expressed in life-cycle emissions of CO<sub>2</sub>-equivalents according to [11]. Impacts on human health are expressed in DALY<sup>3</sup>, impacts on ecosystem quality in terms of species\*yr, both according to [12]. The indicator results are summarized in Figure 2.3, 2.4 and 2.5.

<sup>3</sup>DALY = Disability Adjusted Life Years.

		Grid infrastructure					
		Transformer, HV	Transformer, LV	Electricity transmission network, HV, long-distance	Electricity transmission network, HV	Electricity transmission network, MV	Electricity distribution network, LV
	unit	kg	kg	m	m	m	m
GWP 100a	kg CO2 eq	5.8	4.1	442	125	28.4	16.4
Human Health	DALY	2.91E-05	5.75E-05	1.26E-03	3.21E-04	3.63E-04	3.12E-04
Ecosystem quality	species.yr	5.15E-08	4.30E-08	3.98E-06	1.63E-06	4.95E-07	3.82E-07

Figure 2.5: LCA results of electricity grid infrastructure components; per kg of transformer and per meter of power lines, respectively.

Type	Power	Energy	E/P	Cycle	Cycle	Life	Power	Energy	System	FOM	VOM	Sources:
	MW	MWh	ratio (hr)	efficiency	life #	years	cost USD/kW	cost USD/kWh	cost USD/kWh	USD/kW*a	USD/MWh	
Lead acid	10	40	4	80%	2000	5.5			400			1-9, 11-15
Lithium ion	5	20	4	90%	4000	11.0			1100			1-9, 12-15
Sodium sulfur (NaS)	50	300	6	75%	3500	9.6			400			1-2, 4-15
Vanadium redox flow battery (VRFB)	50	200	4	75%	12000	32.9			600			1-4, 6-15
D-CAES <sup>1</sup> , surface	50	250	5	70%	10950	30	1100	175	395	3.0	3.0	2, 4-6, 8-13, 15
D-CAES, underground	200	1600	8	70%	10950	30	867	16	124	3.0	3.0	"
AA-CAES, <sup>2</sup> underground	200	1600	8	70%	10950	30	867	38	146	3.0	3.0	"

1: For diabatic compressed air energy storage units (D-CAES), efficiency includes natural gas input, i.e. eff. = (electricity out)/(electricity in + heat in). Heat rate is 3900 and 3800 Btu in/kWhe out, respectively.

2: For advanced adiabatic compressed air energy storage unit (AA-CAES), no supplemental natural gas is used.

Sources: 1 - Battke et al (2013), 2 - BFE (2013), 3 - Bielizt (2016), 4 - Chen et al (2009), 5 - Evans et al (2012), 6 - Ferreira et al (2013), 7 - IET-JRC (2013), 8 - Kousksou et al (2014), 9 - Luo et al (2015), 10 - NREL (2009), 11 - Poullikkas (2013), 12 - Sandia (2011), 13 - Sandia (2013), 14 - WEC (2016), 15 - Zakeri and Syri (2015).

Figure 2.6: LCC results for storage technology options (Phase 2 EEM modeling).

## 2.5.2 LCC results on the technology level

Life cycle costs on the technology level are provided at the system boundary where the plant (generation or storage) meeting the transmission grid (also called the busbar cost, comparable to the cradle-to-gate measure for the LCA analysis). The average cost (or levelized cost of electricity) at technology level depends on the *assumed* capacity factor (or the annual generation). However the *actual* capacity factor depends upon system dispatch or operation, and hence upon system load and other generation (or storage) resources. Results are provided below for the key cost parameters, as well as the other key technology characteristics for the storage technologies (battery and CAES) in Figure 2.6

The dispatchable load (electrolysis) technology costs are shown for a wide range of size in Figure 2.\* below (note the logarithmic scale for size). Although a quite wide range of PEM electrolysis references were surveyed (see references), very few sources specifically addressed the issues of cost scaling versus size. For this reason, the main references for the PEM electrolysis cost data were (Genovese et al 2009) and (Ainscough et al 2014). The fitted cost curve that is shown in Figure 2.7 appears to be piecewise linear, but is actually of the form  $ax^b + c$ , where only a few points were graphed.

As noted above, in Phase 1 of ISCHESS the PEM electrolyzer was located at the interface of the local distribution network with the higher voltage transmission grid. Hence, the use of the electrolyzer would be based on the grid energy price, rather than the local PV generation, and it would run whenever the variable cost of electricity is less than the value of the hydrogen produced (based on the H2 transport sector value, and the electrolyzer efficiency). However, the question is then how many hours per year does the electrolyzer operate, and is this sufficient to recoup the fixed investment in the capital cost. Figure 2.8 below shows the EPEX price duration curve for Switzerland between 2007 and 2015.

Based on the EPEX data the number of hours of operation and the total annual cost of electricity were calculated, and combined with the fitted cost curve in Figure 2.8. Figure 2.9 below shows the net revenue per kg of hydrogen produced, based on electrolyzer size and the year of the EPEX energy price data. As can be seen, the electrolyzer only barely breaks even for the largest sized electrolyzers and for the last two years.

The results depend on the EPEX data in two ways. First the load curve price data varies sig-

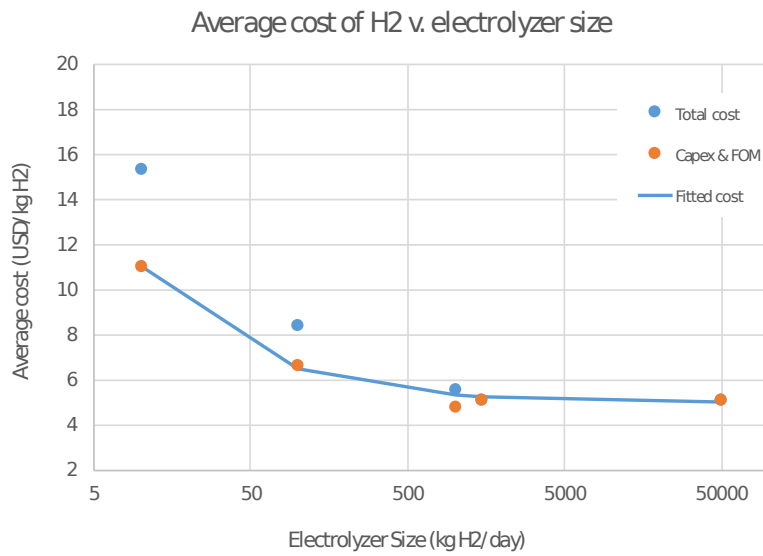

Figure 2.7: PEM electrolyzer cost per kg of hydrogen for different plant sizes.

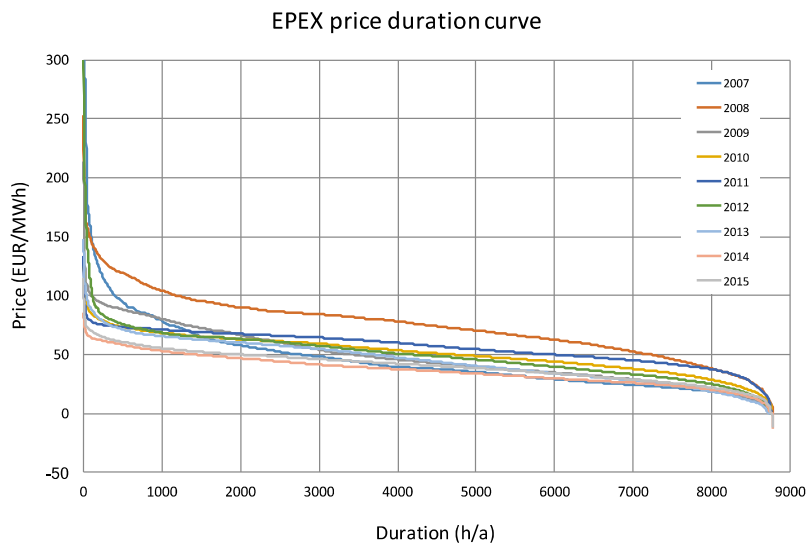

Figure 2.8: EPEX energy price data for hydrogen electrolysis.

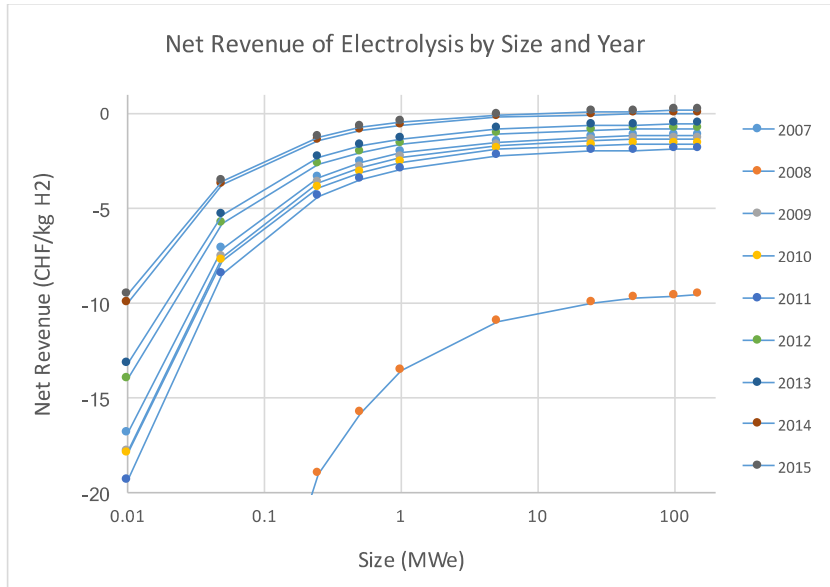

Figure 2.9: Net revenue per kg for hydrogen electrolysis.

nificantly between years, and in particular in 2008 the costs were so high that the electrolyzer would only operate 1271 hours (v. 8666 hours in 2015). Second, it was assumed that the hydrogen price was in Swiss Francs, while the EPEX data is in EUR/MWh, so the results also depend on the growing strength of the Swiss Franc which made the declining electricity prices in Euro's even less expensive in Francs.

References used for storage technology options in Figure 2.6:

- Battke et al (2013). Battke B., Schmidt T., Grosspietsch D. Hoffmann V., “A review and probabilistic model of lifecycle costs of stationary batteries in multiple applications,” *Renewable and Sustainable Energy Reviews* 25 (2013) 240-250.
- BFE (2013). “Energiespeicher in der Schweiz: Bedarf, Wirtschaftlichkeit und Rahmenbedingungen im Kontext der Energiestrategie 2050.” Projektnummer 810000227, Bundesamt für Energie, 12. Dezember 2013.
- Bielitz (2016). Bielitz C., “Environmental and Economic Life-Cycle Assessment of Battery Technologies for Electricity Storage.” MS thesis, ETH Zurich, 8 February 2016.
- Chen (2009). Chen H., Cong T., Yang W., Tan C., Li Y., Ding Y., “Progress in electrical energy storage system: A critical review,” *Natural Science* 19 (2009) 291-312.
- Evans (2012). Evans A., Strezov V., Evans T., “Assessment of utility energy storage options for increased renewable energy penetration,” *Renewable and Sustainable Energy Reviews* 16 (2012) 4141-4147.
- Ferreira (2013). Ferreira H., Garde R., Fulli G., Kling W., Lopes J. “Characterisation of electrical energy storage technologies,” *Energy* 53 (2013) 288-298.
- IET-JRC (2013). Gago Da Camara Simoes S. Nijs W., Ruiz Castello P., Sgobbi A., Rado D., Bolat P., Thiel C., Peteves E., “The JRC-EU-TIMES model – Assessing the long-term role of the SET Plan Energy technologies”. IET-JRC, Publications Office of the European Union, 2013. EUR 26292, ISBN: 978-92-79-34506-7 (pdf).
- Kousksou (2014). Kousksou T., Bruel P., Jamil A., El Rhafiki T., Zeraouli Y., “Energy storage: Applications and challenges,” *Solar Energy Materials & Solar Cells* 120 (2014) 59-80.
- Luo (2015). Luo X., Wang J., Dooner M., Clarke J., “Overview of current development in electrical energy storage technologies and the application potential in power system operation,” *Applied Energy* 137 (2015) 511-536.
- NREL (2009). Steward D., Saur G., Penev M., Ramsden T., “Lifecycle Cost Analysis of Hydrogen Versus Other Technologies for Electrical Energy Storage,” Technical Report NREL/TP-560-46719, November 2009.
- Poullikkas (2013). Poullikkas A., “A comparative overview of large-scale battery systems for electricity storage,” *Renewable and Sustainable Energy Reviews* 27 (2013) 778-788.
- Sandia (2011). “Energy Storage Systems Cost Update, A Study for the DOE Energy Storage Systems Program,” Sandia Report SAND2011-2730, April, 2011.
- Sandia (2013). DOE/EPRI 2013 Electricity Storage Handbook in Collaboration with NRECA, Sandia Report SAND2013-5131, July 2013.

- WEC (2016). "World Energy Resources, E-storage: Shifting from cost to value, Wind and solar applications", World Energy Council, 2016, ISBN: 978 0 946121 44 1. Zakeri and Syri (2015). Zakeri B., Syri S., "Electrical energy storage systems: A comparative life cycle analysis," *Renewable and Sustainable Energy Reviews* 42 (2015) 569-596.

References used for hydrogen electrolysis in Figure 2.7:

- Ainscough et al (2014). Ainscough C., Peterson D., Miller E., "Hydrogen Production Cost from PEM Electrolysis," DOE Hydrogen and Fuel Cells Program Record 14004, July 1, 2014.
- Bertuccioli et al (2014). Bertuccioli L., Chan A., Hart D., Lehner F., Madden B., Standen E., "Development of Water Electrolysis in the European Union," Fuel Cells and Hydrogen Joint Undertaking, Final Report, February 2014.
- Felgenhauer & Hammacher (2015). Felgenhauer M., Hamacher T., "State of the art of commercial electrolyzers and on-site hydrogen generation for logistic vehicles in South Carolina," *International Journal of Hydrogen Energy* 40 (2015) 2084-2090.
- Gardiner (2014). Gardiner M., "Hydrogen for Energy Storage," U.S. DOE Fuel Cell Technologies Office, Hannover Messe, April 7-11, 2014.
- Genovese et al (2009). Genovese J., Harg K., Paster M., Turner J., "Current (2009) State-of-the-Art Hydrogen Production Cost Estimate Using Water Electrolysis National Renewable Energy Laboratory report NREL/BK-A61-46676, September 2009.
- Hamdan (2014). Hamdan M., "High Efficiency Large PEM Electrolyzers," Giner, Inc., Hanover Messe, April 7-11, 2014.
- James et al (2014). James B., Moton J., Whitney G., "Hydrogen Pathways Analysis for Polymer Electrolyte Membrane (PEM) Electrolysis," Project ID: PD102, 2014 DOE Hydrogen and Fuel Cells Program and Vehicle Technologies Office Annual Merit Review and Peer Evaluation Meeting, June 16-20, 2014.
- Mittelsteadt et al (2015). Mittelsteadt C., Norman t., Rich M., Willey J., "Ch. 11 PEM Electrolyzers and PEM Regenerative Fuel Cells Industrial View," *Electrochemical Energy Storage for Renewable Sources and Grid Balancing*, Elsevier, 2015.
- Noack et al (2015). Noack C., Burggraf F., Hosseiny S., Lettenmeier P., Kolb S., Belz S., Kallo J., Friedrich K. A., Pregger T., Cao K., Heide D., Naegler T., Borggreffe F., Büniger U., Michalski J., Raksha T., Voglstätter C., Smolinka T., Crotogino F., Donadei S., Horvath, P., Schneider G., "Studie über die Planung einer Demonstrationsanlage zur Wasserstoff-Kraftstoffgewinnung durch Elektrolyse mit Zwischenspeicherung in Salzkavernen unter Druck," Deutsches Zentrum für Luft- und Raumfahrt, Stuttgart, February 2, 2015.
- Sanghai (2013). Sanghai Y., "Techno-Economic Analysis of Hydrogen Fuel Cell Systems Used as an Electricity Storage Technology in a Wind Farm with Large Amounts of Intermittent Energy," MS thesis, University of Massachusetts Amherst, 2013.

- Saur (2008). Saur G., “Wind-To-Hydrogen Project: Electrolyzer Capital Cost Study,” National Renewable Energy Laboratory report NREL/TP-550-44103, December 2008.
- Saur & Ramsden (2011). Saur G., Ramsden T. “Wind Electrolysis: Hydrogen Cost Optimization,” National Renewable Energy Laboratory report NREL/TP-5600-50408, May 2011.

### 2.5.3 Data gaps, uncertainties and limitations

**Life Cycle Assessment** Data quality of lead acid and Li-Ion batteries as well as hydrogen generation and electricity generation and supply can be rated as high. However, LCI data of PV electricity generation are slightly outdated; considering the fact that a large share of PV modules is imported from China today (with higher associated environmental burdens [19]), which is not well represented within the current LCI data, the PV related LCA results should represent the current status well. Data quality of VRF batteries and components for grid reinforcement and expansion is somewhat lower. Information concerning manufacturing energy demand for VRFB was not available and could therefore only be included in a generic way and to a minimum extent. The LCI data for power lines and transformer stations are relatively old; further, only generic data can be used, which will not represent location specific aspects likely to be important in the context of grid expansion. Also selection of technologies as such (and exclusion of others) introduces uncertainties. Current Li-Ion batteries rather represent application in battery electric vehicles than stationary use. Furthermore, different battery chemistries and manufacturing processes (from the technology selected) would be associated with different environmental burdens [20], [21]. And fundamentally different future battery technologies such as Li-air [22] could substantially change environmental burdens [23].

Further uncertainties in the results are due to uncertainties in performance indicators such as lifetime, efficiencies, etc. of the technologies involved and in the application scenarios. For example, Li-Ion batteries from battery electric vehicles (BEV) could further be used for stationary applications as soon as their performance would be insufficient for use in BEV [24],[25], [26], [27], with substantial environmental benefits for both types of application.

**Life Cycle Cost** Data quality for the cost data has some problematic aspects. One of the key findings of the present cost survey, and also one of the findings of the technology surveys surveyed, is that battery cost results can vary very widely, both within a specific battery family (e.g. lead-acid) and the target application (short-term, daily, or seasonal), so that the cost ranges for different battery chemistries overlap widely. This is true even for the mature technologies (like lead-acid), and of course especially true for the less mature chemistries, and also those battery families where there are many related alternatives (e.g. the wide range of lithium chemistries). A close comparison is generally only possible based on manufacturer’s specifications for specific models for a specific target use and duty cycle. For the dispatchable load electrolysis, only polymer membrane fuel cells were considered due to their size and speed of response characteristics. However there is also still significant uncertainty here due to data sources, continuing development and economies of scale. This is not to say that the cost results are worthless, but rather that they reflect a rapidly developing field, where there is more data on older and less effective alternatives, and less data on newer and hopefully better alternatives.

## **2.6 Conclusions**

### **2.6.1 Life Cycle Assessment (LCA)**

LCA related conclusions concerning this WP2 only concern LCI data (i.e. inputs to the regional and national modeling), since LCA results for specific components of the electricity supply system on their own are hardly meaningful; the environmental performance of components, e.g. batteries depends on their application and operation parameters such as lifetime and efficiency.

Data quality for the available inventory data is mixed. While for certain battery technologies (VRFB, future Li-Ion) as well as hydrogen and electricity generation data quality can be considered as high, inventory data for lead acid batteries and grid expansion/reinforcement are relatively old and probably less accurate. Furthermore, a large variety of Li-Ion battery technologies exist, which could not be represented within the scope of this analysis. Also the fast innovation cycles in battery technology development could not be represented within the given project boundary conditions. As a consequence, uncertainties related to some of the available LCA results are high.

### **2.6.2 Life Cycle Cost (LCC)**

As with LCA, the cost conclusions here are necessarily technology-specific, since total system costs depend upon the interactions of the entire system with the storage and dispatchable load technologies considered. As noted above, battery costs vary widely within as well as across the different families of batteries, and also depend on parameters including efficiency, lifetime, and operating cycle. The cost and operating parameters given above are representative, but real accuracy is mostly limited to cases where a specific battery type and vendor can be matched to a specific application. As with the LCA, rapid developments and a broad range of chemistries (e.g. Li-ion in particular) mean that the results are more a 'snapshot' of the current state of the art. The major conclusion for the PEM electrolyzer was that based on the value of hydrogen, the annual costs for electricity and fixed capital and O&M costs, only the largest electrolyzers will break even if currently low electricity costs continue.

## **2.7 Future work**

### **2.7.1 Life Cycle Assessment (LCA)**

Future work must aim at increasing the quality of LCI data in terms of temporal and technology-related representativeness. New inventory data should be established for stationary battery technologies, which are supposed to enter the market soon. Also appropriate LCI data for large-scale grid reinforcement/expansion (e.g. for transformer stations and transmission lines at different voltage levels) need to be developed. For all components involved, consistent prospective inventory data should be established.

In addition to the currently applied attributional LCA approach, consequential LCA should be applied in order to capture the consequences of a large-scale transformation of the Swiss energy supply system in a better way.



## 2.7.2 Life Cycle Cost (LCC)

Methodologically, there is no real need to further develop the levelized cost methodology. The major emphasis in future work is rather to keep the cost data current with the developments of the various technologies, some of which are advancing more rapidly than others. This includes not only the capital costs, but also the key operating parameters that affect unit technology costs. The battery costs can be expected to decline more rapidly than the CAES storage, particularly for battery types that are used in the transport sector. It is also expected that fuel cell costs will continue to drop, but at slower rates since the stack costs decline most strongly, and are already less than half of the overall system costs. Future work on dispatchable loads could also focus more on control of other existing consumer, commercial and industrial loads, as applicable, and improved analysis of the spot market interactions. Finally, grid expansion costs could be improved by more detail of terrain-specific costs, or even line specific costs for major transmission projects.

## References

- [1] ISO. *ISO 14040. Environmental management - life cycle assessment - principles and framework*. 2006.
- [2] ISO. *ISO 14044. Environmental management - life cycle assessment - requirements and guidelines*. 2006.
- [3] EC. *International Reference Life Cycle Data System (ILCD) Handbook - General guide for Life Cycle Assessment - Detailed guidance*. Tech. rep. Luxembourg, 2010.
- [4] J Mason Earles and Anthony Halog. "Consequential life cycle assessment: a review". In: *The International Journal of Life Cycle Assessment* 16.5 (June 2011), pp. 445–453. ISSN: 1614-7502.
- [5] Alessandra Zamagni et al. "Lights and shadows in consequential LCA". In: *The International Journal of Life Cycle Assessment* 17.7 (Aug. 2012), pp. 904–918. ISSN: 1614-7502.
- [6] S Hellweg and L Milà i Canals. "Emerging approaches, challenges and opportunities in life cycle assessment". In: *Science* 344.6188 (2014), pp. 1109–1113.
- [7] S Suh and G Huppes. "Methods for life cycle inventory of a product". In: *Journal of Cleaner Production* 13.7 (2005), pp. 687–697.
- [8] S Suh and S Nakamura. "Five years in the area of input-output and hybrid LCA". English. In: *The International Journal of Life Cycle Assessment* 12.6 (2007), pp. 351–352.
- [9] PréConsultants. *SimaPro 8.04.30 Multi user*. 2015.
- [10] Ecoinvent. *the ecoinvent LCA database, v3.1, "cut-off by classification"*. 2014.
- [11] S Solomon et al. *Climate Change 2007: The Physical Science Basis. Contribution of Working Group I to the Fourth Assessment Report of the Intergovernmental Panel on Climate Change*. Tech. rep. 2007.
- [12] M Goedkoop et al. *ReCiPe 2008 - A life cycle impact assessment method which comprises harmonised category indicators at the midpoint and the endpoint level*. Tech. rep. First edition, 2008.

- [13] J L Sullivan and L Gaines. "Status of life cycle inventories for batteries". In: *Energy Conversion and Management* 58 (2012), pp. 134–148.
- [14] D A Notter et al. "Contribution of Li-Ion Batteries to the Environmental Impact of Electric Vehicles". In: *Environmental Science & Technology* 44.17 (2010), pp. 6550–6556.
- [15] C Bielitz. "Environmental and Economic Life-Cycle Assessment of Battery Technologies for Electricity Storage". PhD thesis. Zurich, 2016.
- [16] X Zhang et al. "Life Cycle Assessment of Power-to-Gas: Approaches, system variations and their environmental implications". In: *Applied Energy* 190 (2017), pp. 326–338.
- [17] A Simons and C Bauer. "Life cycle assessment of hydrogen production". English. In: *Transition to Hydrogen: Pathways Toward Clean Transportation*. Ed. by A Wokaun and E Wilhelm. Cambridge; New York, United States of America: Cambridge University Press, 2011. ISBN: 9780521192880 0521192889.
- [18] Karin Treyer and Christian Bauer. "Life cycle inventories of electricity generation and power supply in version 3 of the ecoinvent database—part I: electricity generation". In: *The International Journal of Life Cycle Assessment* 21.9 (Sept. 2016), pp. 1236–1254. ISSN: 1614-7502.
- [19] D Yue, F You, and S B Darling. "Domestic and overseas manufacturing scenarios of silicon-based photovoltaics: Life cycle energy and environmental comparative analysis." In: *Sol Energy* 105 (2014), pp. 669–678.
- [20] L Ellingsen et al. "Life Cycle Assessment of a Lithium-Ion Battery Vehicle Pack". In: *Journal of Industrial Ecology* 18.1 (2014), pp. 113–124.
- [21] J B Dunn et al. "The significance of Li-ion batteries in electric vehicle life-cycle energy and emissions and recycling's role in its reduction". In: *Energy & Environmental Science* 8.1 (2015), pp. 158–168.
- [22] J Christensen et al. "A Critical Review of Li/Air Batteries". In: *Journal of The Electrochemical Society* 159.2 (2011), R1–R30.
- [23] G P Hammond and T Hazeldine. "Indicative energy technology assessment of advanced rechargeable batteries". In: *Applied Energy* 138 (2015), pp. 559–571.
- [24] L Ahmadi et al. "Environmental feasibility of re-use of electric vehicle batteries". In: *Sustainable Energy Technologies and Assessments* 6 (2014), pp. 64–74.
- [25] L Ahmadi et al. "A cascaded life cycle: reuse of electric vehicle lithium-ion battery packs in energy storage systems". In: *The International Journal of Life Cycle Assessment* (2015), pp. 1–14.
- [26] L Casals et al. "Second life of electric vehicle batteries: relation between materials degradation and environmental impact". In: *The International Journal of Life Cycle Assessment* (2015), pp. 1–12.
- [27] K Richa et al. "Environmental trade-offs across cascading lithium-ion battery life cycles". In: *The International Journal of Life Cycle Assessment* (2015), pp. 1–16.

## 3 WP3: Distribution Grid Modelling

### 3.1 Introduction

This workpackage develops the framework for the study of renewable energy source (RES) integration in distribution grids. Using the example of photovoltaic (PV) power and distribution grid examples of the CKW network in the central-Swiss region, the goal is to determine the maximum admissible PV installation in a given grid scenario using different integration strategies like grid extension, curtailment, reactive power control or storage.

Photovoltaic (PV) energy sources are a popular solution for the generation of electrical energy. As the most important renewable energy source (RES) besides hydro and wind power, it is widely used ranging from small individual systems of a few kW to large installation of several MW rated power. The entry barrier for individual private operators is relatively low, leading to an increasing share of PV generation in distribution grids.

A unified PV integration problem with the structure of a general AC OPF problem is formulated and used for both the planning and operation of the PV sources. Studies of real models and scenarios of large Swiss distribution grids with rural, urban and industrial characteristics indicate a strong benefit from the addition of distributed storage components, such as batteries, compared to the other integration strategies.

Distribution grids have traditionally a unidirectional power flow, from the feeder to the end consumer. With intermittent PV generation, this flow may be altered or reversed and may cause violation of voltage level or thermal line loading bounds.

This section discusses the software tools used for the planning and operation of *distribution grids* with a large share of RES components. The tools will also be used in large parts for the planning and operation on the transmission grid level, see WP5 for the current status of the transmission grid aspects.

### 3.2 Objectives

The focus of this section are the planning and operational consequences of large scale PV installation in existing distribution grids. A two step procedure is proposed to determine the maximum admissible PV capacity. First, the maximum injection capacity of the current grid is determined, independent of the actual PV profile. Secondly, a range of state-of-the-art RES integration strategies, including reactive power control, curtailment and storage, are compared regarding their effectiveness, of reaching and extending this injection capacity with PV generation.

Essentially, all integration strategies increase the controllability of the network and are cast into a unified PV integration problem for both the operation and the dimensioning of the system's PV, storage and control devices, similar to the method in [1]. The optimization problem retains the structure of a general AC optimal power flow problem (OPF) that can be solved using available state of the art solvers and ensures the feasibility of the grid constraints. If the solution is employed in a receding horizon fashion for the system operation, it corresponds to a nonlinear model predictive control scheme.

A second contribution is the application of the grid optimization problem to models of selected Swiss distribution networks, planning and operating hundreds of PV and storage devices. A large

connected distribution area is separated into sub-grids with rural, industrial and urban characteristics and a PV integration study is performed. The results represent a bound on the achievable grid performance, using a central coordination of the systems PV, storage and control devices.

### 3.3 Scope

To execute a distribution grid simulation, optimization and planning study, two essential inputs are required.

1. First, a mathematical formulation of the technical power grid components on a relevant time scale, such as household loads, cables, lines, transformer and storage components.
2. Secondly, a time trajectory of the relevant grid inputs during current and future operation, such as load profiles, cost profiles and PV profiles.

The software tools that were developed for the two inputs are presented in the subsequent sections. The PV integration case of this project is illustrated in [2].

### 3.4 Methodology - Grid optimization procedure

The software tool developed for the quantitative assessment of the RES integration strategies is structured in two levels.

First, the optimal grid operation does not alter the network, but only uses the available controllable components to optimize the grid performance over a given operation or prediction horizon, for instance 24 hours in a day-ahead operational planning.

Secondly, the grid planning uses benchmark scenarios to select the optimal grid investments for the selected scenarios, for instance representative days of past or estimated future grid conditions.

Both steps will formulate the problem as mathematical optimization problem with the following structural properties:

- A nonlinear multi-period AC power flow problem that can be solved with extensions of standard software implementations, in this case the MATLAB toolbox Matpower [3].
- Approximative solution approaches can be obtained with linearization based models [4], [5], [6] and SDP relaxations [7]. These approximation neglect or simplify the reactive power and voltage magnitude coupling of the network. For this study, no such approximations were necessary. The problems can efficiently solved and potentially parallelized possible with the setup of MATPOWER / IPOPT / PARDISO (<http://www.pardiso-project.org>) [8], [9].
- Further improvement of the solution speed possible by exploiting the problem structure (ongoing development in related projects at FEN).

In both steps, the approach assumes a centralized coordination of the available grid control signals. This provides an optimal bound on the achievable performance using the selected approaches. In practise, the grid operator may prefer a more decentralized or clustered operation,

for instance of groups of PV panels using only local measurements, resulting in a possibly worse performance.

### 3.4.1 Optimal grid operation

The problem has the following structure:

$$J^* = \left( \min_{u_1, \dots, u_N} \sum_{i=1}^N l_i(x_i, u_i) \right)$$

$$\text{s.t. } \forall i = 1, \dots, N : g(x_i, u_i) \leq 0, \quad h(x_i, u_i) = 0,$$

where  $N$  is the prediction horizon, e.g. 24 hours with  $i$  denoting the timestep. The vector  $u_i$  denotes the controllable components at each time step, for instance storage signals or RES curtailment signals. The vector  $x_i$  denotes the grid variables at each time step, including voltage magnitudes, voltage angles and line power flows. The vector function  $g(\cdot, \cdot)$  denotes the grid inequality constraints at each time step, for instance thermal limits, rate limits, generation limits or voltage limits. The vector function  $h(\cdot, \cdot)$  denotes the grid equality constraints at each time step, for instance the Kirchhoff network equation and storage update equations.

### 3.4.2 Optimal grid planning

To extend the grid operation method to the grid planning method, an additional optimization layer is introduced.

$$J^* = \min_p \left( \min_{u_1, \dots, u_N} \sum_{i=1}^N l_i(x_i, u_i, p) \right) \quad (1)$$

$$\text{s.t. } \forall i = 1, \dots, N : g(x_i, u_i, p) \leq 0, \quad h(x_i, u_i, p) = 0, \quad (2)$$

The planning parameter  $p$  includes extension of existing grid components (such as lines, cables and transformers) and the size and location of the storage units in the system. Additional parameters included the degree of PV curtailment and the degree of participation in demand side management. The outer optimization layer can be included in the basic multi-period OPF problem formulation used for the grid operation. Constraints affecting the continuous linear constraints, such as the storage size, can be directly included as new parameter without changing the problem structure. Discrete parameter or parameters entering the problem constraints in a nonlinear fashion, such as the grid upgrade parameters for lines, transformers and cables, are included by sampling the corresponding value ranges.

### 3.4.3 Parametric solution approach

A key element is the parametric solution of the grid planning problem. Rather than committing to a specific value for the battery degradation and cost parameter or the grid upgrade costs, the grid operator receives as result a lookup table that allows to extract the optimal investment decisions for various assumed parameter, for instance included in an investment risk analysis.

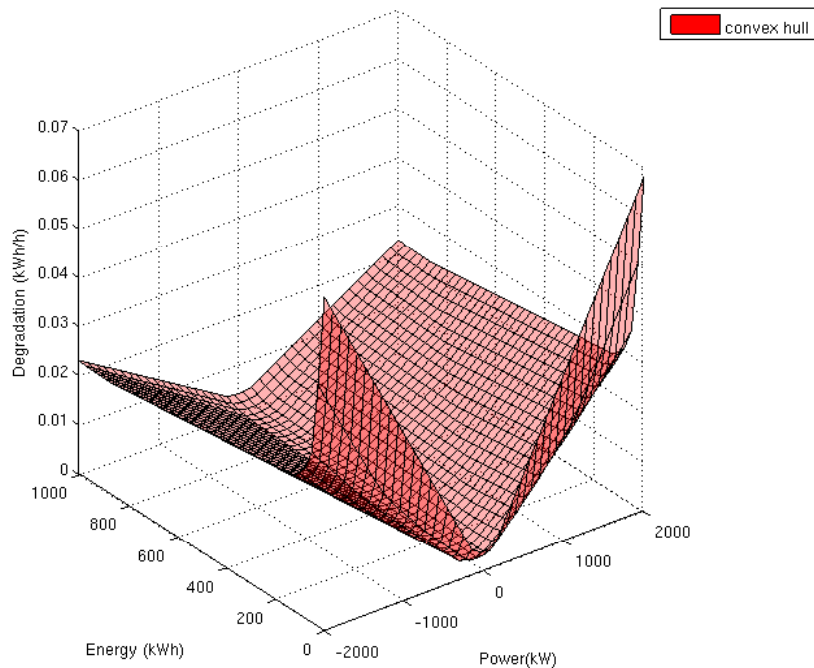

Figure 3.1: Example degradation curve of the battery cost model used in the distribution grid model (data used for Lithium-Ion models).

In this report, the parametric solution is provided along the following strategic problem parameters:

- three different battery cost parameters
- grid upgrade cost (left as independent parameter for the grid operator)
- projected load demand level (high and low scenarios)
- projected average electricity price level (20 - 80 CHF/MWh)
- admissible participation in demand side managements (0 - 30 % per household)

### 3.5 Methodology - Energy pattern generation

This section presents a generation procedure of future hourly supply and demand profiles based on very few key parameters from general predictions for aggregated areas, e.g. in the Energy Strategy 2050 (ES2050).

The section is outlined as follows. Section 3.5.1 outlines reduction and prediction scheme based on nested Fourier transforms enabling a straightforward pattern generation from few key parameters. Section 3.5.3 reviews the sources for data acquisition in the Swiss Energy sector. Section 3.5.2 illustrates the pattern generation scheme with a selected scenario from the ES2050.

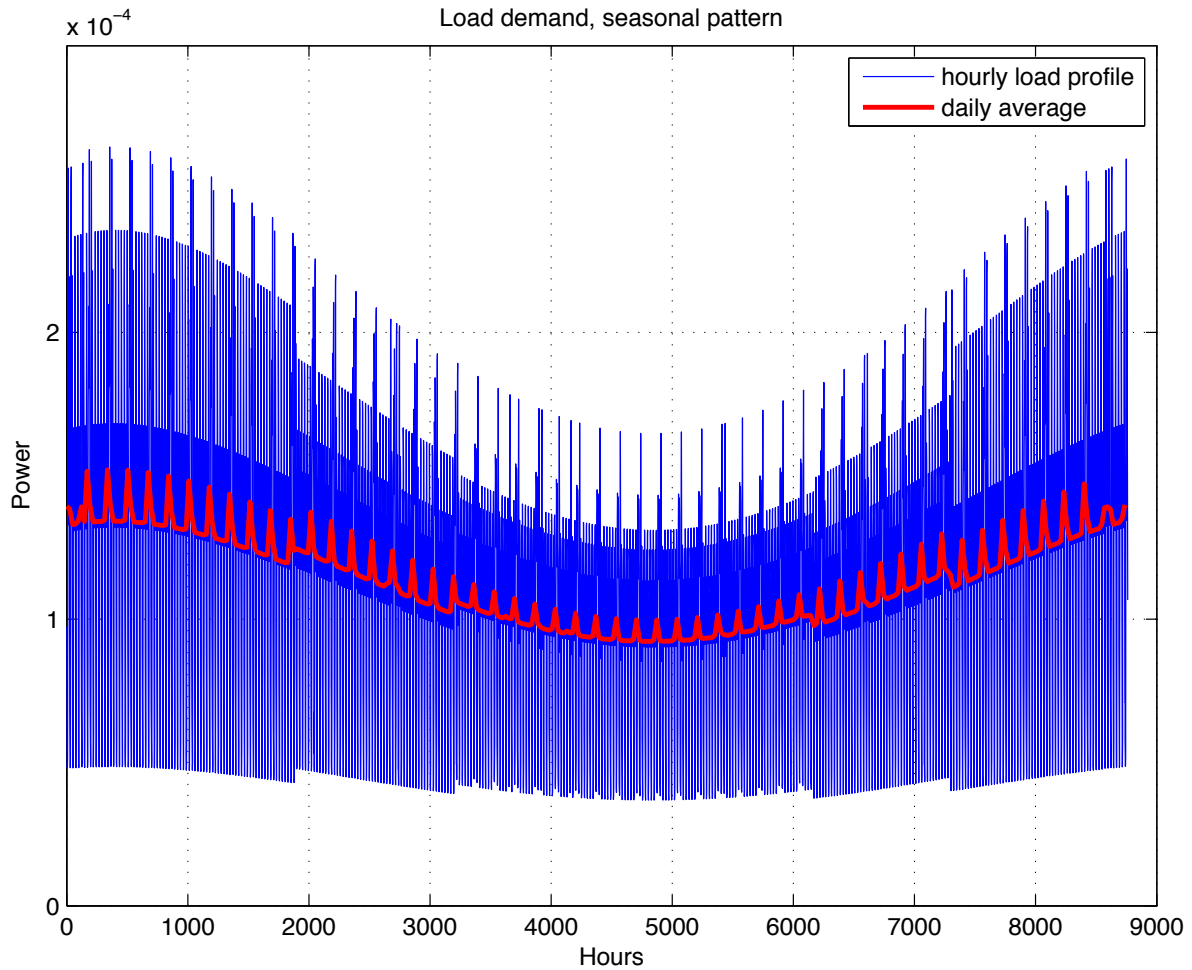

Figure 3.2: Typical load profile

### 3.5.1 Pattern generation from aggregated data

To develop and test RES integration strategies for future energy scenarios, it is necessary to perform a sequence of power flow simulations of the electrical power system, in order to check feasibility and performance of the selected scenario and strategy. These simulation require profiles of the individual load demand and available power injections (e.g. from PV sources) on an hourly or 15 minute time scale covering 24 hours to a few days. However, predictions of the future energy portfolio typically include only a few key parameters, like the predicted total energy consumption of an aggregated area.

Therefore, it is necessary to map these key parameters to a set time series for the geographically distributed nodes in the future power grid. This section addresses the *time series generation* from aggregated parameters. The geographic distribution aspect is topic of ongoing investigations.

Figure 3.2 and Figure 3.3 show a typical hourly load profile over a full yearly. It can be seen that the profile features three pattern characteristics:

- A seasonal pattern of the entire year.
- A weekly pattern with the distinct characteristic for each day of the week and holidays.

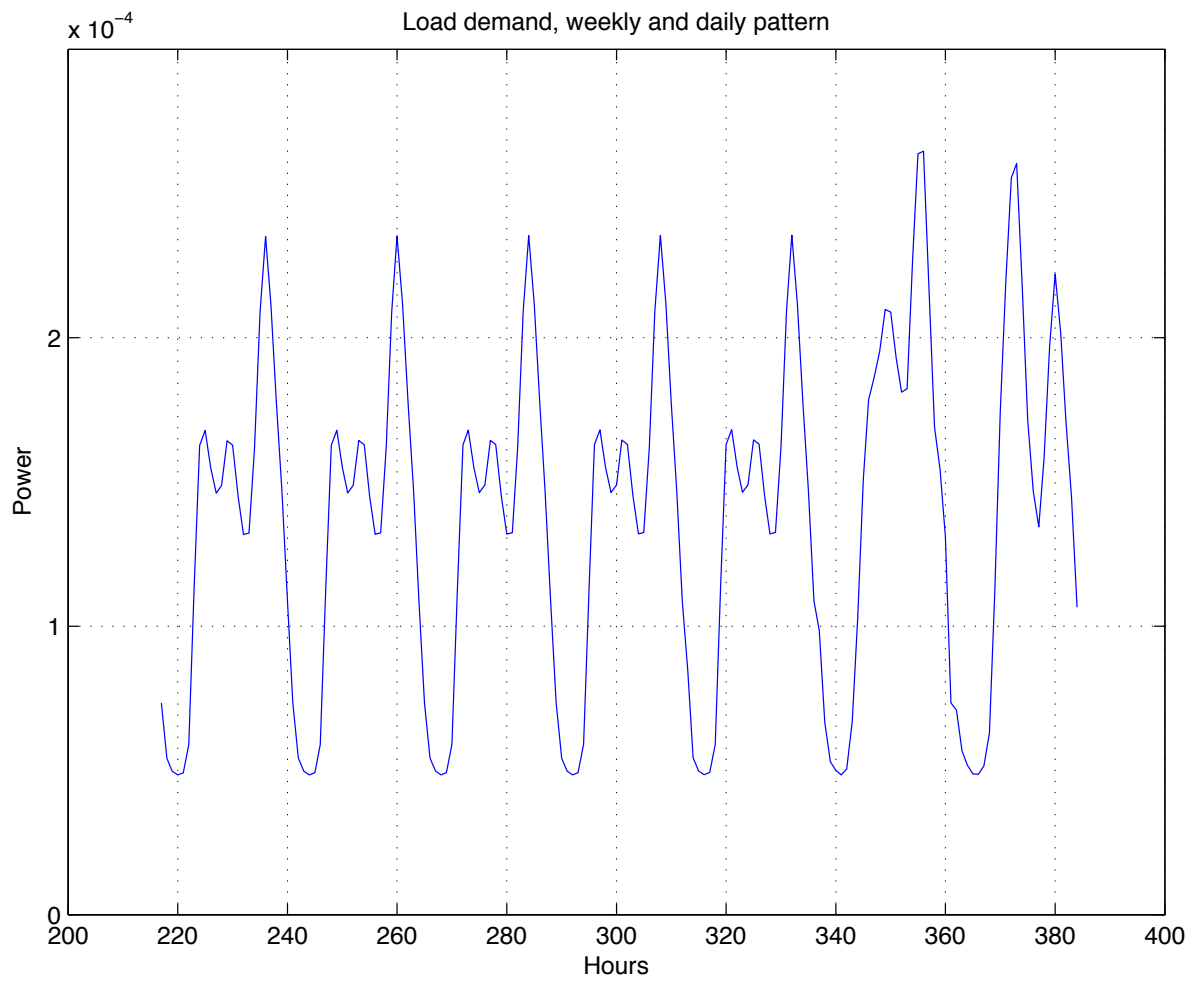

Figure 3.3: Typical load profile (zoom) - weekly and daily pattern



- A daily pattern over 24 hours.

Aside from these characteristics, the patterns are quite repetitive. This motivates a procedure, to extract the essential information from today's profiles, thereby reducing the amount of redundant information and making it available to generate and tune alternative energy profiles.

A systematic procedure for the information extraction from a time series and the corresponding backwards step to generate the original profile is the (truncated) Discrete Fourier Transform (DFT) and the corresponding Inverse Discrete Fourier Transform (IDFT). Figure 3.4 shows the DFT of all Wednesdays in a year, taken over 24 hour intervals. Each datapoint corresponds to the magnitude or phase of the given harmonic (colour coded) at the given week of the year (on the x-axis). It can be seen that the magnitudes and phases of the DFTs slowly change over the year in an almost sinusoidal fashion. This allows to break down the overall time series using the following reduction steps:

- Approximation of 24 hours using a truncated DFT, keeping the average and the first 4 harmonics of the 24 hour DFT.
- Separate evaluation of each weekday.
- Approximation of seasonal trends using a simple DFT with one harmonic (sinusoidal signal over the 51 weeks).

This allows to reduce the overall information content by over 99% keeping only the key parameters. For the inverse transform, the 24 hour profile of a selected day in a selected week of the year can be generated by computing the seasonal value of the relevant DFT parameters and taking the IDFT of those.

Figure 3.5 illustrates that the reduction step has little impact on the inverse signal compared to the original data.

### 3.5.2 Load pattern generation example

The pattern can now be easily scaled (changing the average) or distorted (changing one of the harmonics) in order to include the future development of the overall load profile and possible changes of load peaks during the day or within the week.

Figure Fig. 3.6 shows the development of the annual Swiss energy demand and PV generation according to the scenario *Weiter-wie-bisher / Fossil-zentral* of the ES2050. This annual information (one value for each year) can now be used to predict future load profiles by combining it with typical profiles measured today (as depicted in Fig. 3.2).

Fig. 3.7 illustrates the hourly load demand with three predicted scenarios of the ES2050 for a week in July in the year 2035. It can be seen that phenomena such as increased fluctuations or shifts between the weekdays can be directly incorporated in the generation procedure.

### 3.5.3 Data sources and outlook

The current scenario data used for the illustrations has the following source:

- Quantitative data of ES2050 in 5-year-timesteps publicly available

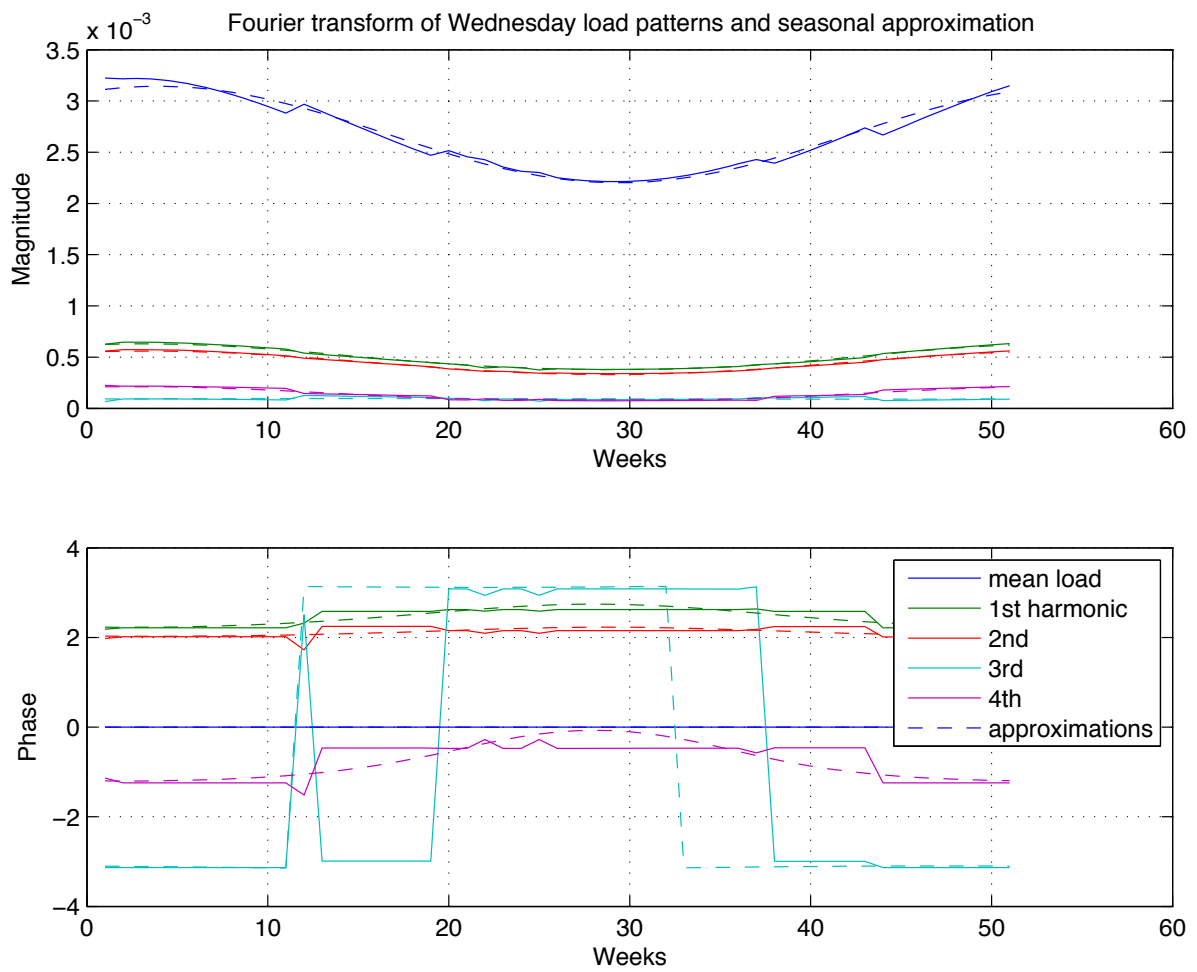

Figure 3.4: Fourier analysis of 24 hour pattern over one year with seasonal approximation

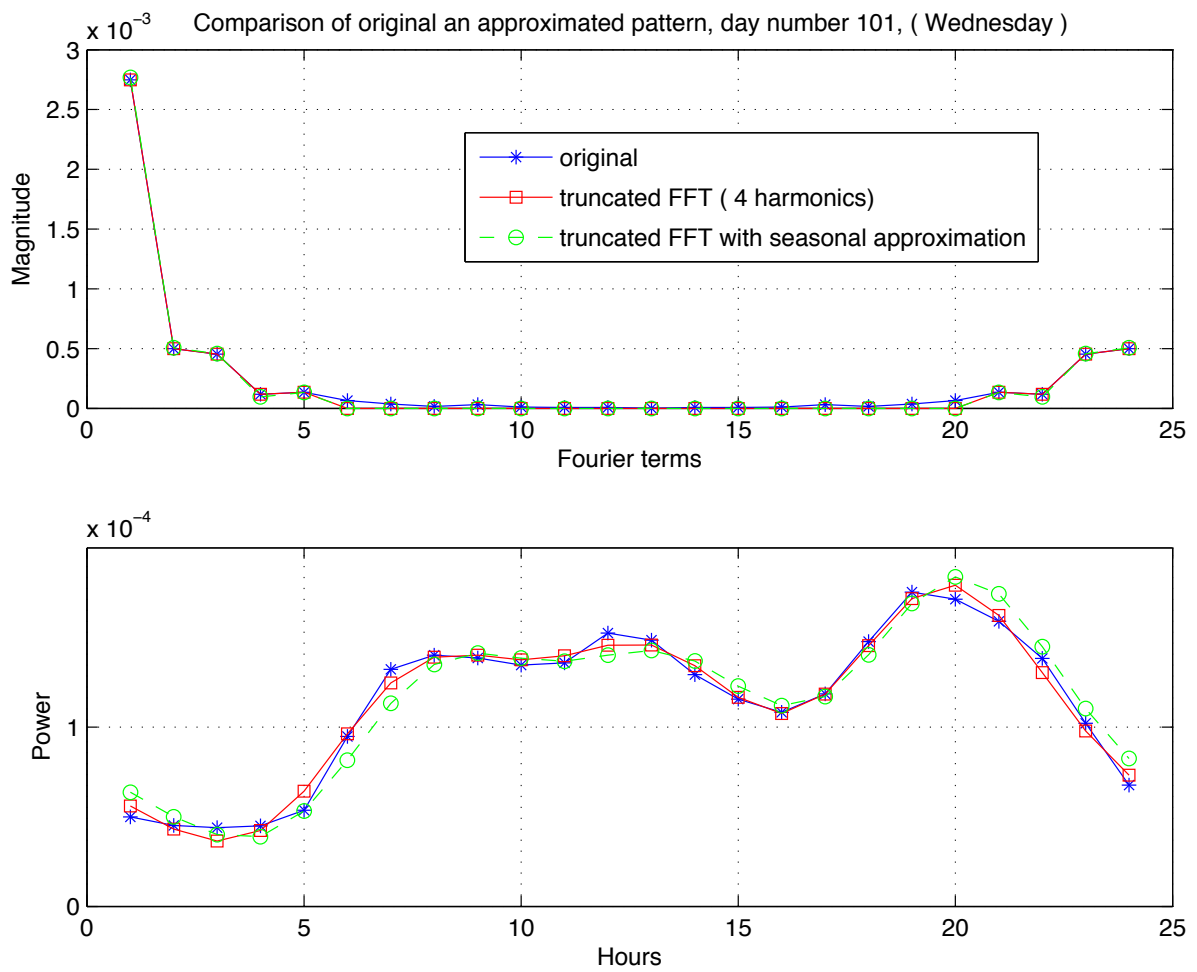

Figure 3.5: Comparison of load pattern with generated approximation

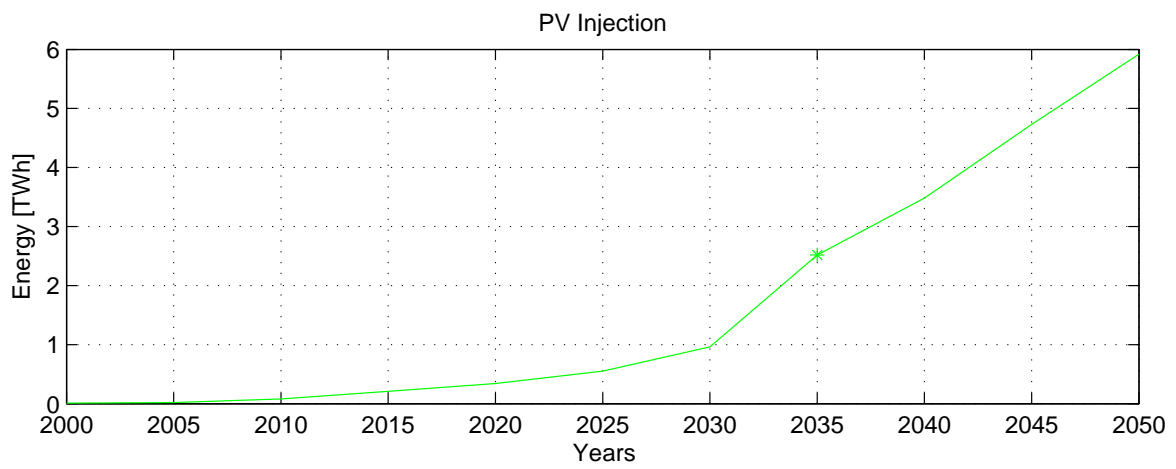
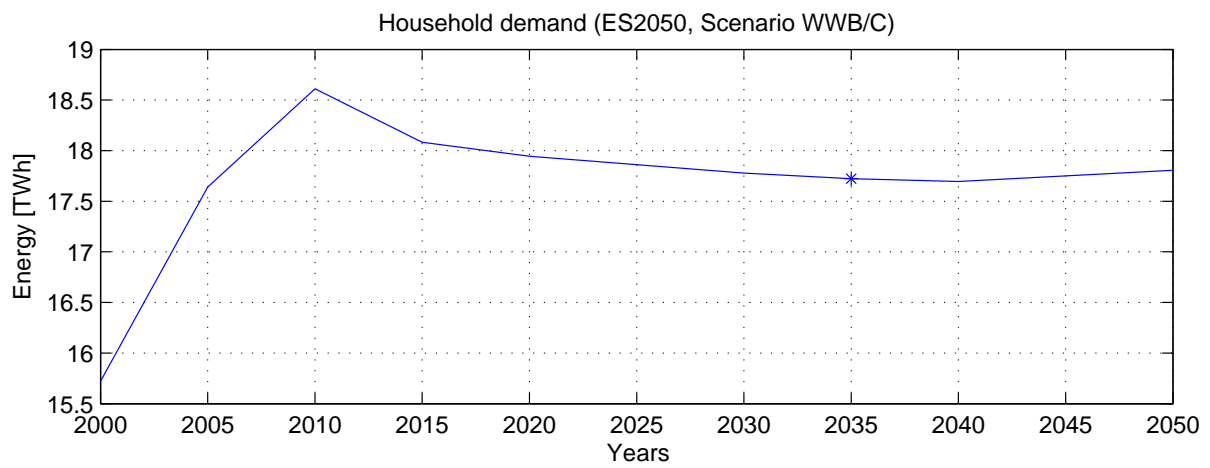

Figure 3.6: Swiss load demand and PV injections from ES2050

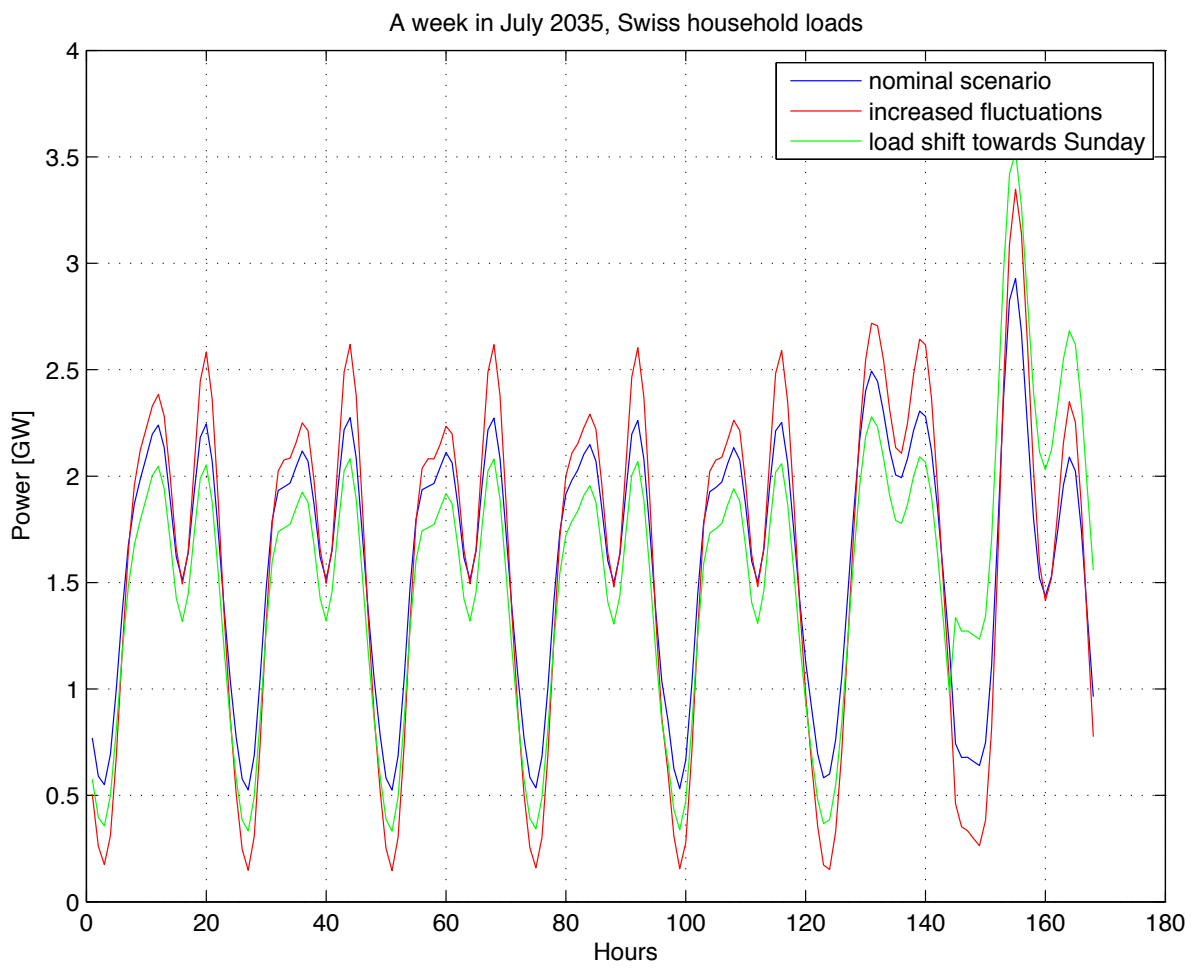

Figure 3.7: Generated patterns for one week in July 2035

- Quantitative data of ES2050 in 1-year-timesteps was provided for internal use by Prognos
- Scaling parameters for more ambitious or more conservative scenarios can be directly applied, but have to be estimated
- Further scenarios (ENTSO-E, IEA, ETH study) can be accounted for with this framework

In the future of the ISCHESS project, the pattern generation scheme will be used for all illustrations with load profiles: This involves the extension of the pattern generator to other load and generation classes (PV, hydro-power, nuclear, ...), possibly with stochastic components.

Furthermore, the goal is a creation of a database of public prediction sources and the interfacing with a power grid simulation. The grid integration of the profiles of PV sources is illustrated in the next section.

### 3.5.4 Conclusion

The advantages of the proposed pattern generation procedure can be summarized as follows:

- No full data acquisition required, only typical patterns and annual data.
- Exploitation of redundant information (data reduction by more than 99 %).
- Easy to adjust for different future scenarios.

The difficulties of the procedure are the same that occur in any approach for the prediction of future energy patterns:

- Exceptional events still have to be modeled manually (e.g. holidays).
- Requires explicit assumptions of daily, weekly and seasonal patterns.

## 3.6 Results

The distribution grid model used for the PV integration studies is based on a portion of a Swiss distribution grid and is illustrated in Fig. 4.1. Fig. 3.9 and Fig. 3.10 show the price, the load and the solar radiation profile used for the time scenarios.

Three parameter types are used to parameterize the PV integration strategies:

- Curtailment as needed (C1) or PV capacity chosen to always respect the grid constraints and to avoid curtailment (C0).
- Reactive power control within symmetric bounds (Q1) or no reactive power control (Q0).
- Storage devices at the PV buses with size proportional to the PV rating (S1) or no storage (S0).

Curtailment (C1) and no curtail

Distribution grid with 934 nodes (dots), 933 branches (lines), 0 loops (black),  
2 voltage levels and 21 trafos (blue).

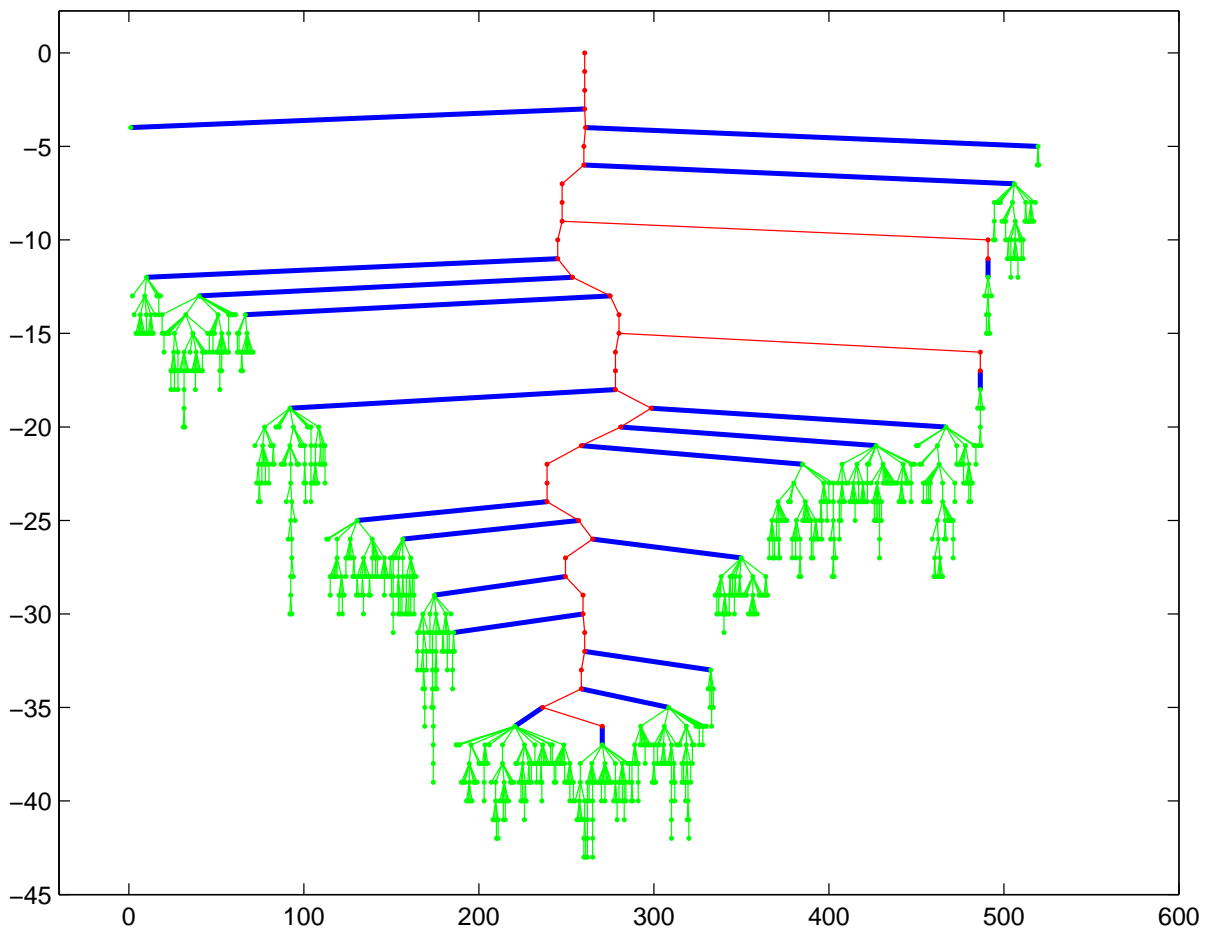

Figure 3.8: Rural section of a distribution grid with 390 nodes, 1 feeder (black square), 20 kV lines (red), 400 V lines (green) and 16 transformer (blue).

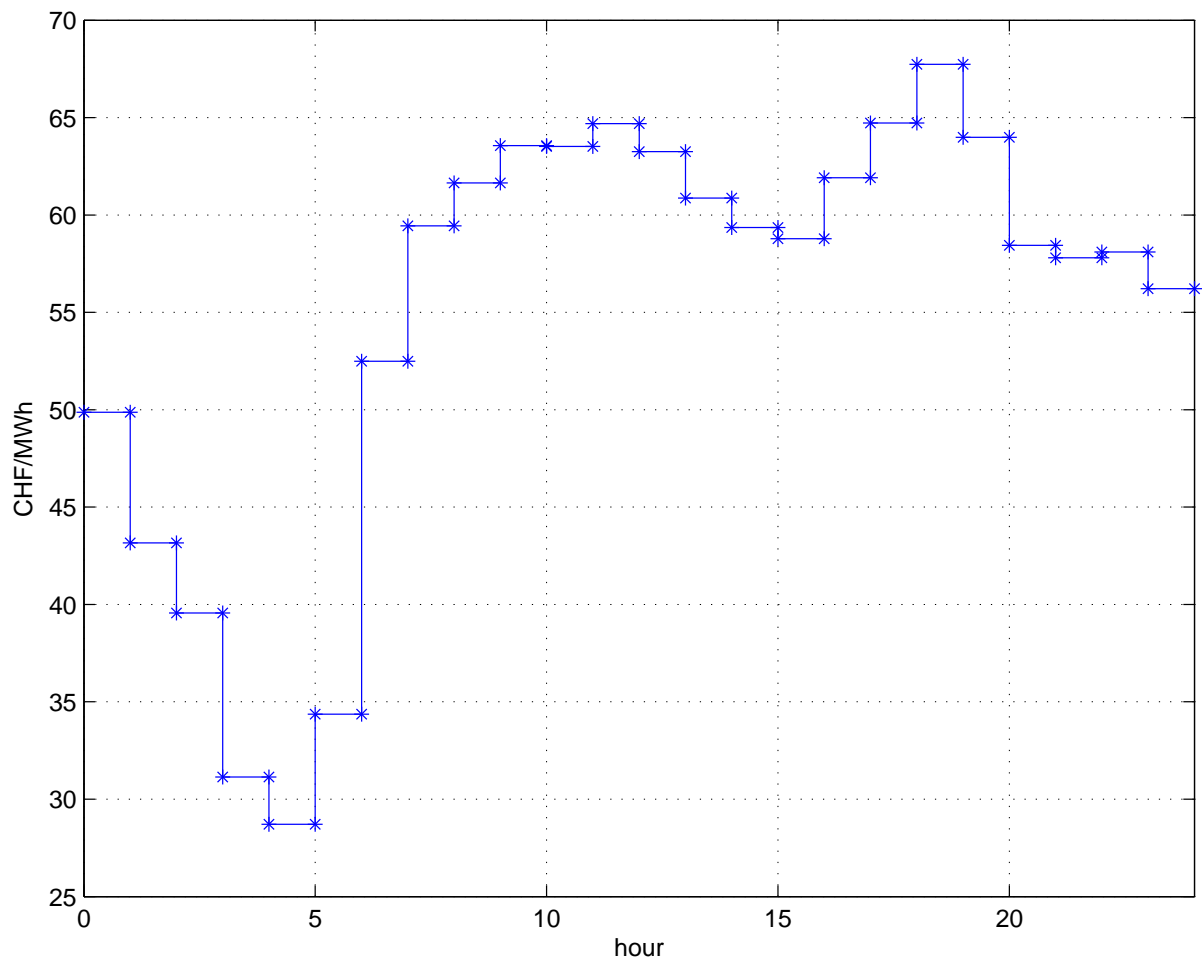

Figure 3.9: PV integration studies: Price profile  $c_i$  over 24 hours, used at the feeder of the grid in Fig. 4.1.



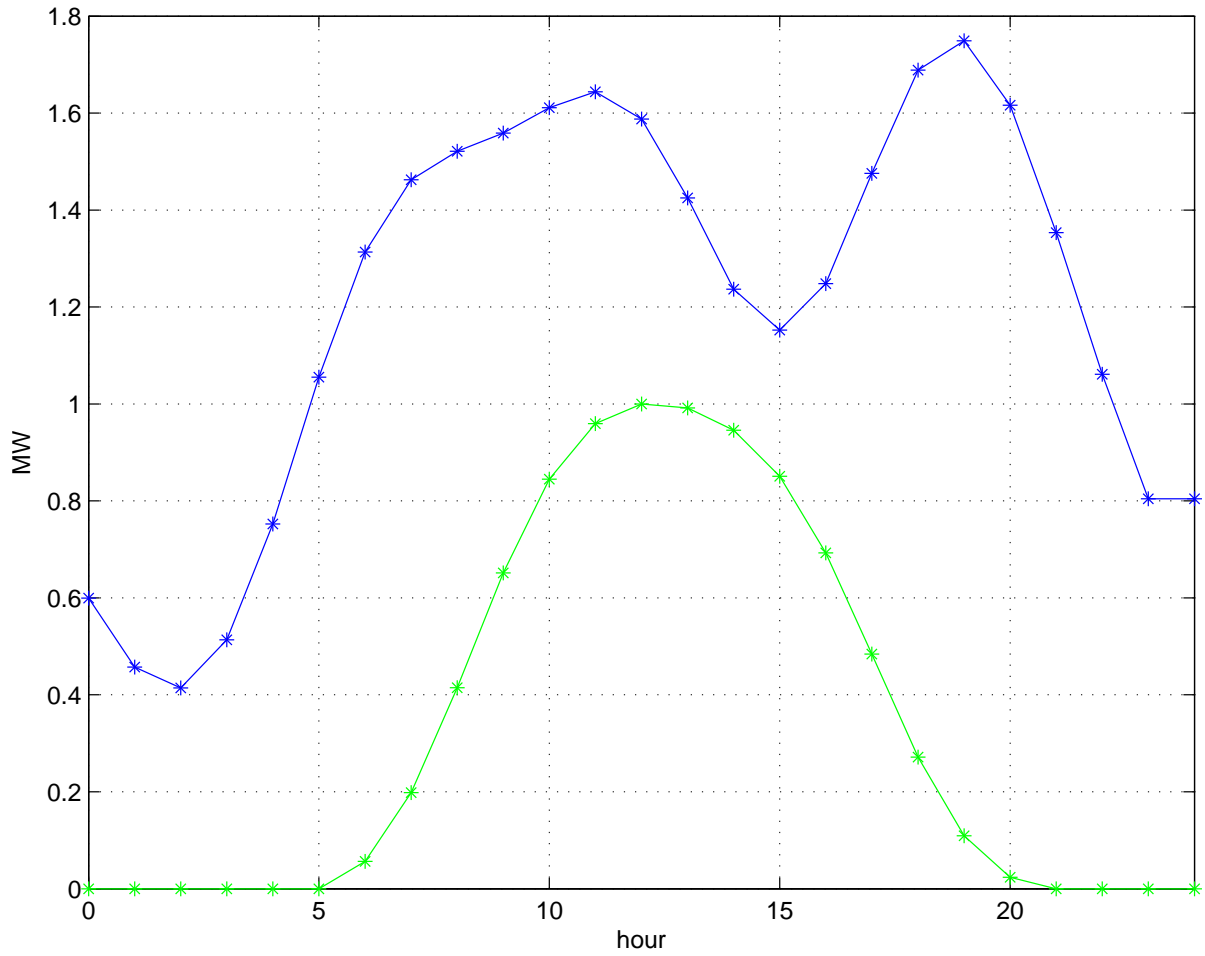

Figure 3.10: PV integration studies: Total load in the grid over 24 hours (blue, summed over all nodes in the grid in Fig. 4.1) and solar radiation profile  $r_{PV,i}$  (green, normalized to 1 MW).

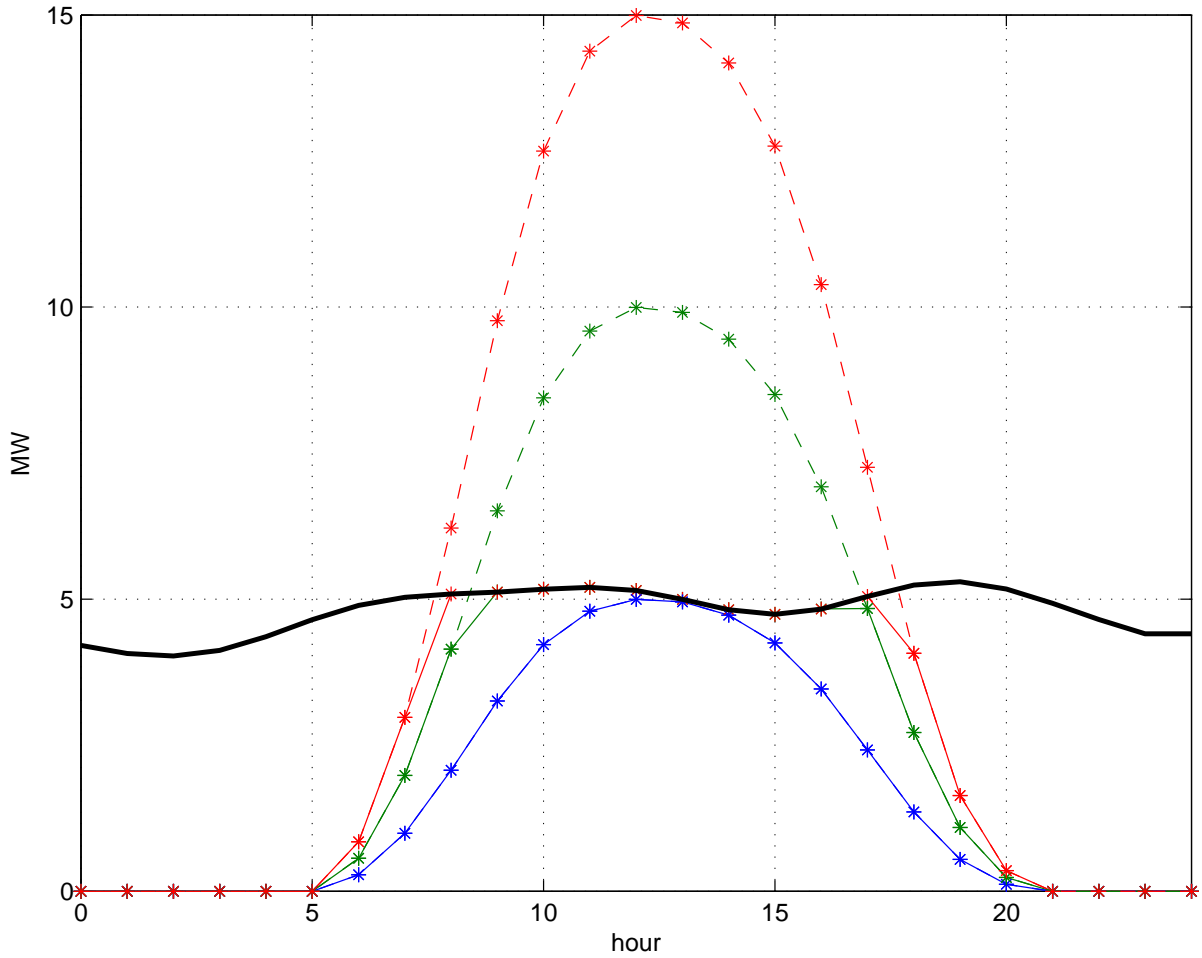

Figure 3.11: PV integration studies regarding *Curtailment*: Grid PV power injections for different PV capacities. Maximum PV capacity without curtailment  $P_{PV}^*$  (blue),  $2 \cdot P_{PV}^*$  (green),  $3 \cdot P_{PV}^*$  (red). Available PV power (dashed) and injected PV power (solid). Upper bound with theoretical maximum injections (bold black).

### 3.6.1 Curtailment

The basic AC OPF study using determined the maximum admissible power injection into the distribution grid for all time instances, which is indicated as bold black curve in Fig. 3.11. The rated PV capacity was scaled to match but never exceed the maximum admissible power  $P_{PV}^*$ , thereby leading to no curtailment, as shown in the blue curve in Fig. 3.11. The remaining curves show that larger PV systems allow to increase the total injection, but can not make full use of the available PV power. Fig. 3.12 shows that the large PV installations allow to produce more power than locally demanded and to sell PV power through the feeder (negative costs). However improvement in operational costs becomes smaller with growing PV capacities.

### 3.6.2 Storage

A storage devices is placed at each bus with PV injections and scaled to hold up to one hour of the rated PV capacity. The results are illustrated in Fig. 3.13 and Fig. 3.14. It can be seen that the storage and PV operating controller purchases additional power during the night when prices are low (see Fig. 3.9) to charge the 203 storage devices in this simulation the power is injected

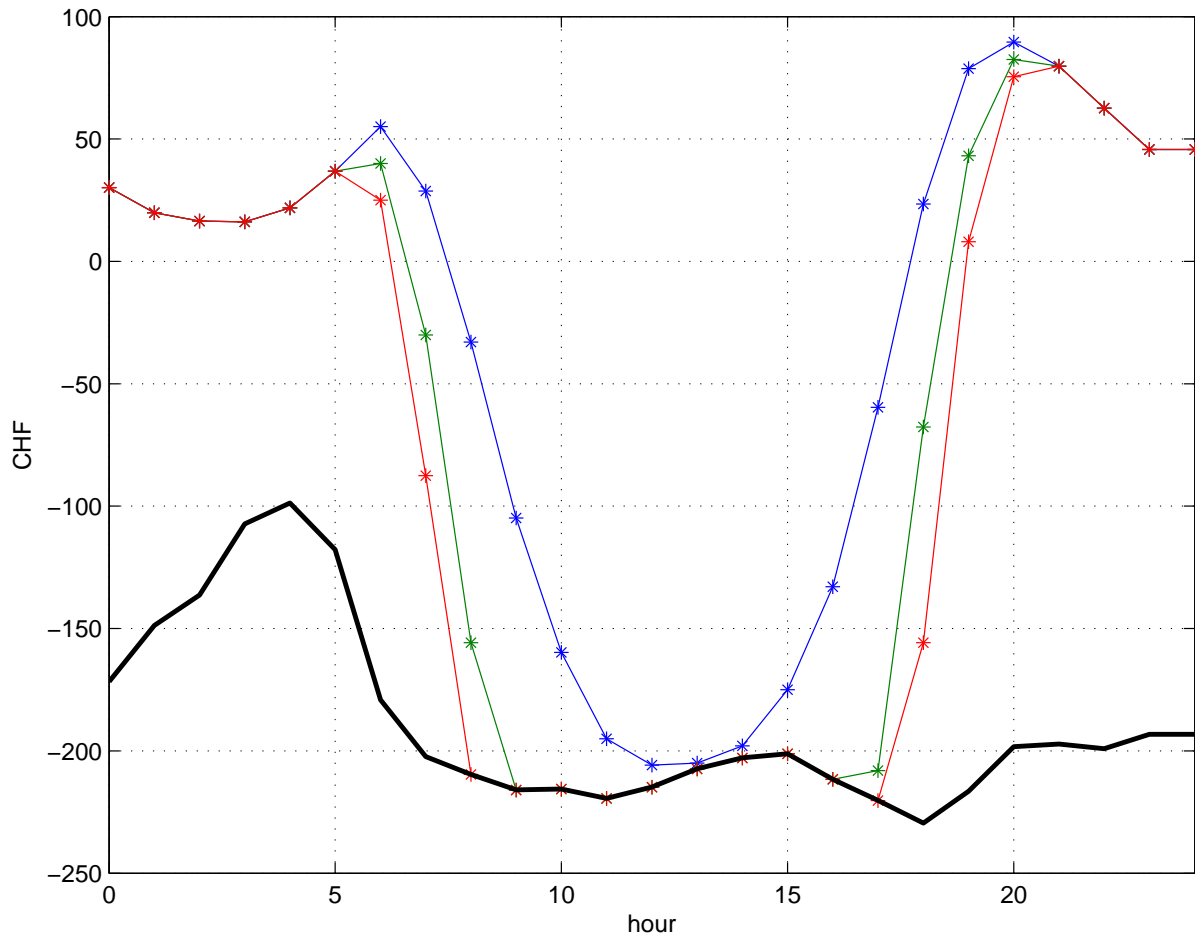

Figure 3.12: PV integration studies regarding *Curtailment*: Grid operation cost for different PV capacities. Maximum PV capacity without curtailment  $P_{PV}^*$  (blue),  $2 \cdot P_{PV}^*$  (green),  $3 \cdot P_{PV}^*$  (red). Lower bound with theoretical maximum injections (bold black).

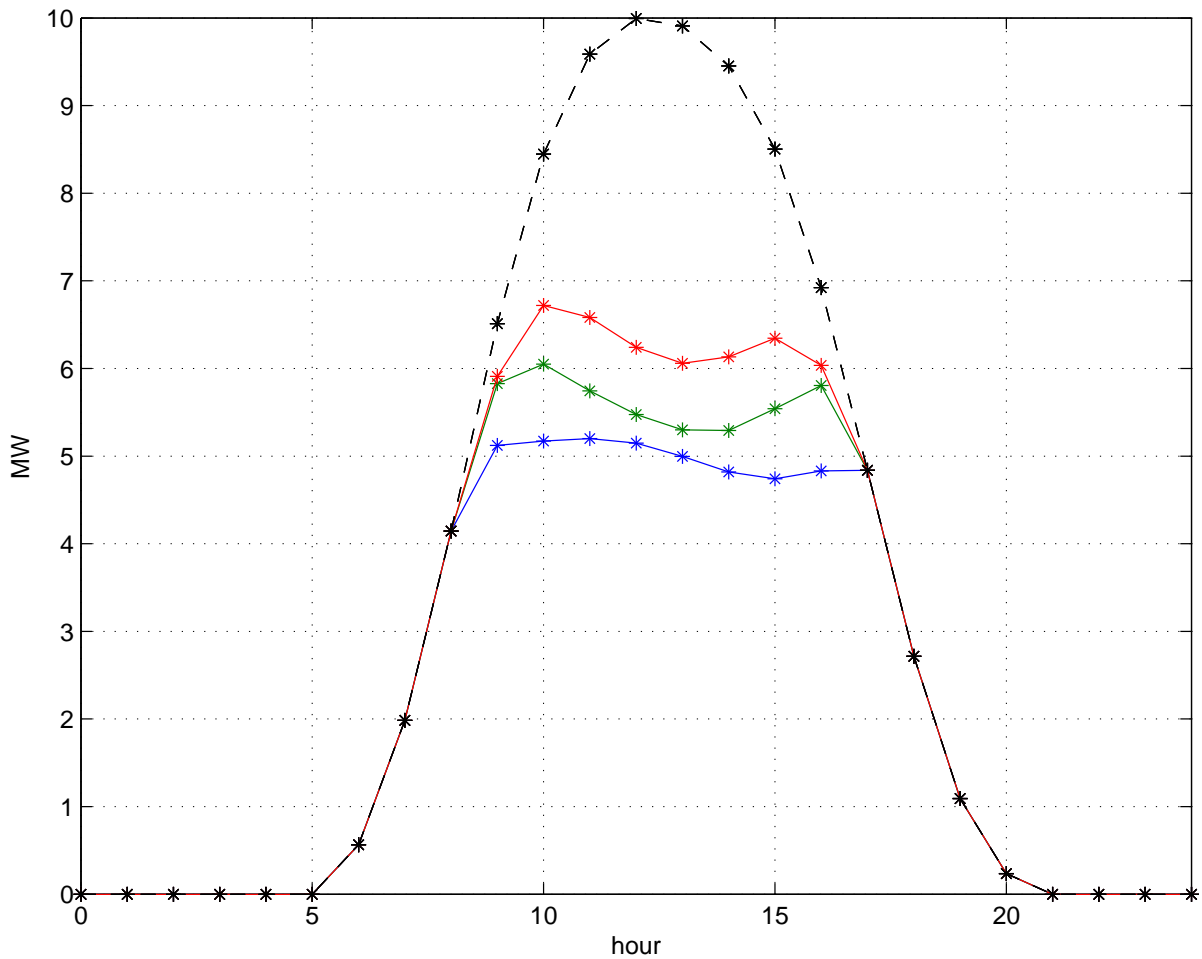

Figure 3.13: PV integration studies regarding *Storage*: Grid PV power injections for different storage levels. No storage (blue), Storage for 30 minutes PV injections (green), Storage for 1 hour PV injections (red). Available PV power (black dashed).

in the morning when prices rise and solar power is not yet fully available. As show also in Fig. 3.15, during the day, the surplus solar power is used to recharge the storage devices and use this energy in the evening.

Note that this is a result of an optimisation of the individual 203 storage devices and PV elements without simplifying rules or assumptions. The computational effort compared to an individual AC OPF computation without storage grows gracefully.

### 3.6.3 Reactive power control

Based on the current study result, reactive power control seems to cause almost no difference in grid performance level.

## 3.7 Conclusions

This section outlined two software tools used for the planning and operation of *distribution grids* with a large share of RES components. First, a mathematical formulation of the technical power grid components on a relevant time scale, such as household loads, cables, lines, transformer and

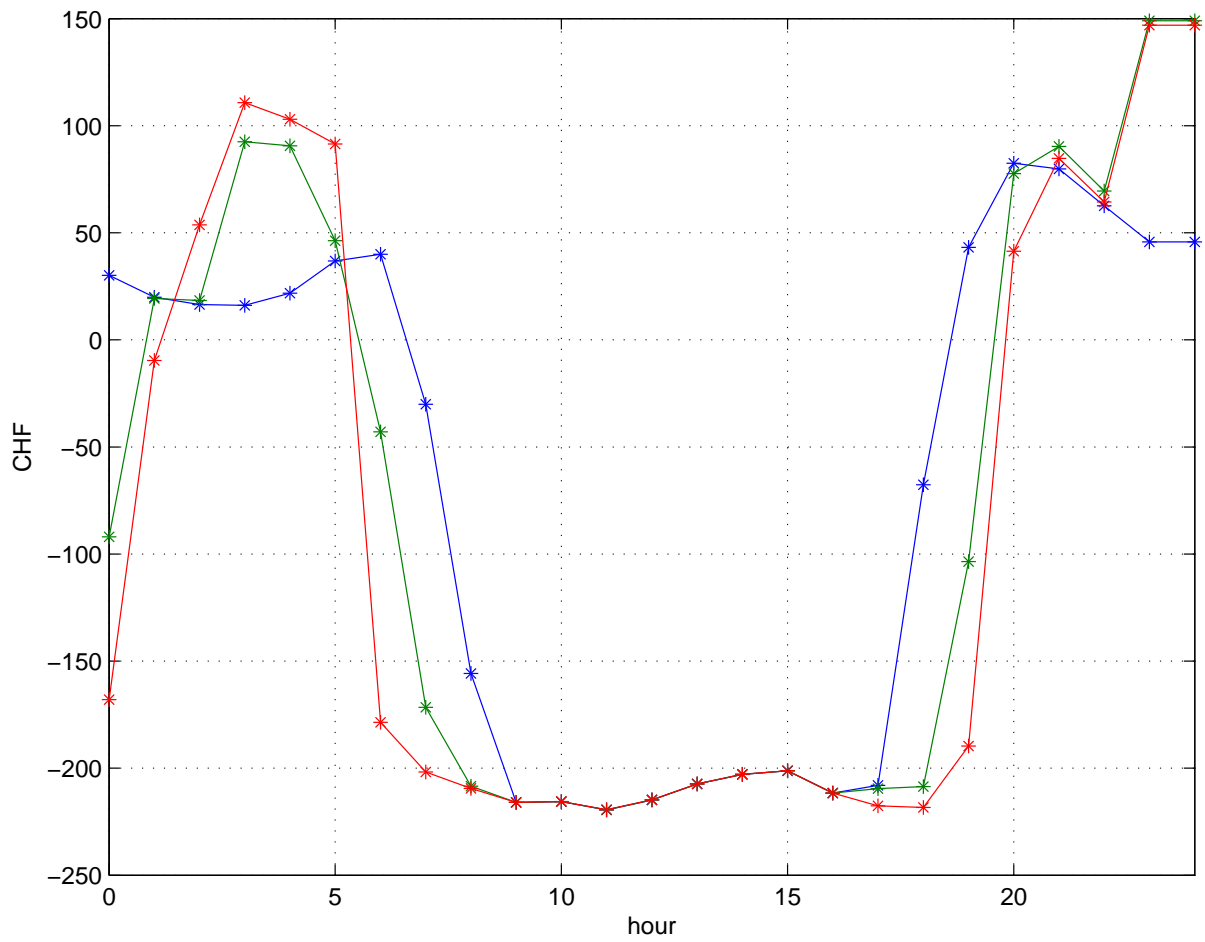

Figure 3.14: PV integration studies regarding *Storage*: Grid operation cost for different storage levels. No storage (blue), Storage for 30 minutes PV injections (green), Storage for 1 hour PV injections (red). Available PV power (black dashed).

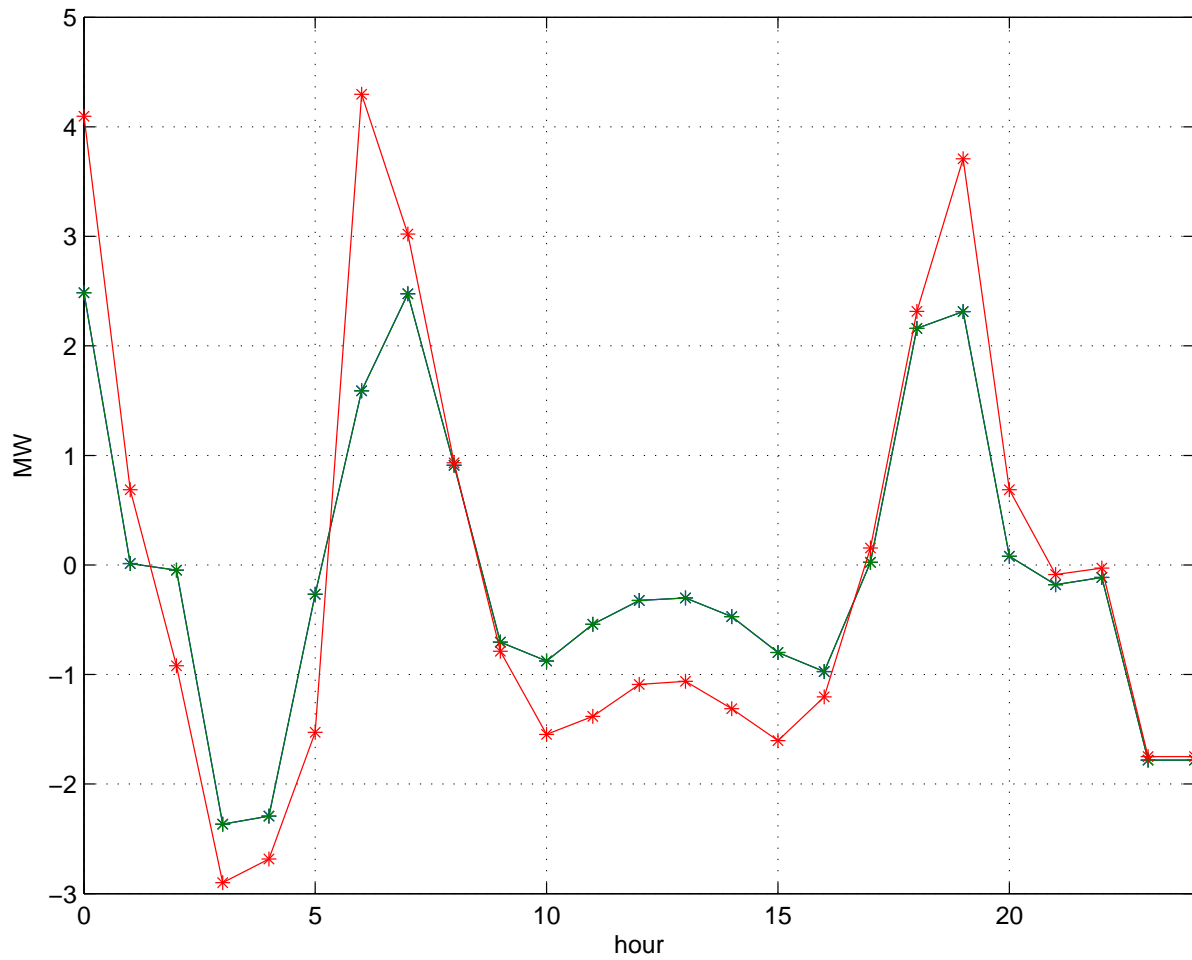

Figure 3.15: PV integration studies regarding *Storage*: Total net storage flow of all storage devices. Storage accomodating 30 minutes PV injections (green),and 1 hour PV injections (red).

storage components. Secondly, a time trajectory of the relevant grid inputs during current and future operation, such as load profiles, cost profiles and PV profiles. The tools will also be used in large parts for the planning and operation on both the distribution and transmission grid level in the subsequent workpackages.

### 3.8 Future Work

The future study will include further comparisons with other distribution grid types (urban, industrial). Furthermore, an animated video of the grid evolution during different strategies is developed to visualize and simplify the selection procedure of different strategies.

### References

- [1] K. Heussen et al. “Unified System-Level Modeling of Intermittent Renewable Energy Sources and Energy Storage for Power System Operation”. In: *Systems Journal, IEEE* 6.1 (Mar. 2012), pp. 140–151.
- [2] A. Fuchs and T. Demiray. “Large-scale PV integration strategies in distribution grids”. In: *PowerTech, 2015 IEEE Eindhoven*. June 2015.
- [3] R. D. Zimmerman, C. E. Murillo-Sanchez, and R. J. Thomas. “MATPOWER: Steady-State Operations, Planning, and Analysis Tools for Power Systems Research and Education”. In: *IEEE Transactions on Power Systems* 26.1 (Feb. 2011), pp. 12–19. DOI: [10.1109/TPWRS.2010.2051168](https://doi.org/10.1109/TPWRS.2010.2051168).
- [4] Kai Heussen et al. “Unified system-level modeling of intermittent renewable energy sources and energy storage for power system operation”. In: *IEEE Systems Journal* 6.1 (2012), pp. 140–151.
- [5] Philipp Fortenbacher, Martin Zellner, and Göran Andersson. “Optimal sizing and placement of distributed storage in low voltage networks”. In: *Power Systems Computation Conference, PSCC 2016, Genoa, Italy, June 20-24, 2016*. 2016, pp. 1–7.
- [6] J. Machowski, J.W. Bialek, and J.R. Bumby. *Power System Dynamics: Stability and Control*. John Wiley & Sons, Ltd., 2008.
- [7] Joseph Warrington et al. “A market mechanism for solving multi-period optimal power flow exactly on AC networks with mixed participants”. In: *2012 American Control Conference (ACC)*. IEEE. 2012, pp. 3101–3107.
- [8] Andreas Wächter and Lorenz T. Biegler. “On the implementation of an interior-point filter line-search algorithm for large-scale nonlinear programming”. In: *Math. Program.* 106.1, Ser. A (2006), pp. 25–57. ISSN: 0025-5610.
- [9] O. Schenk and K. Gärtner. “On Fast Factorization Pivoting Methods for Sparse Symmetric Indefinite Systems”. In: *Elec. Trans. Numer. Anal.* 23 (2006), pp. 158–179.

## 4 WP4: Assessment of alternative RES integration strategies

### 4.1 Introduction

This workpackage presents a full quantitative assessment of different RES integration strategies for the integration in distribution grids. The candidate strategies have been selected regarding their relevance and implementability in low and medium voltage distribution grid with a high share of renewables. All strategies have been implemented using the software and optimization tool outlined in the documentation of WP3.

### 4.2 Objectives

Using the tools developed in WP3, the following general questions should be analyzed and answered within this workpackage:

1. How economic is the use of storage in view of alternative strategies such as curtailment and grid extension?
2. How do the calculation costs of the gridoperator affect the outcome of the planning study?
3. Is Curtailment a valid and economic approach to congestion management?
4. How large is the potential of controllable loads?

### 4.3 Scope

The section first summarize the candidate strategies. It then analyses the principle impact of the strategies on the power grid and provides the details of the investigated benchmark cases and parameter ranges. Finally the simulation results are quantitatively compared and discussed, accompanied by some general conclusions concerning the RES integration in distribution grids.

### 4.4 Methodology

#### 4.4.1 Overview of grid scenarios

The following assumptions form the grid scenarios that form the problem of optimal grid integration. The scenarios are formed by the external parameters that are encountered by the DSO of our case study. They include the grid topology, the available prediction horizon, the time-varying electricity price, the net load demand (consisting of load consumption and distributed PV injection).

- *Grid topology*

The benchmark network and the benchmark scenario used in this study is shown in Fig. 4.1. The network from the CKW grid near the feeder Sursee-14 has 390 nodes, two voltage level and one feeder. The shown results for this network were also repeated for the 6 other CKW networks up to 1000 nodes, that are all connected through the medium voltage grid of the



Sursee region. A combination of all seven networks will be used in the second project phase as a starting point to derive the aggregated grid behavior behind the individual nodes of the Swiss transmission grid.

- *Time horizon*

The time horizon determines the length of the interval considered during by the grid planning optimization. The predictions of the external time series (electricity price, load demand, available PV power) must be available for the entire time horizon. In this case study, the time horizon has been chosen as 48 hours in hourly time steps, covering two representative days with a typical grid operation situation. The prediction are assumed to be perfect, no robustness considerations have been included. In practise, the precision of the prediction is lost for both longer prediction horizons and a finer time resolution, the assumptions try to balance this tradeoff. Also, the validity of the two representative day scenario for a grid planning problem is a point of discussion. However, the following points have to be considered:

- Many parts of the time series for price, PV power and load are repetitive and allow an identification of representative key patterns, thereby supporting the selected approach.
- An a postiori simulation of a full measurement sequence of an entire year is still possible to check the feasibility of the planning result from the two day optimization.
- Longer planning horizons require to model a sequence of prediction intervals terminating after a fixed prediction prediction period (e.g. a planning over a full year with a sequence of 24 hour prediction horizons). This complicates the problem formulation considerably.

The two representative days have been selected as a typical summer and winter weekday of 2014, driven by the available data mentioned in the following items.

- *Electricity price*

The time series for the electricity price have been obtained from the day-ahead auction prices of the Epex spot market (<http://epexspot.com/>) for the two representative days. To simulate a possible future increase or decrease to a new average price  $c_{\text{price}}$ , the price signal has shifted (not scaled) to the required average value, in order to preserve the volatility of the price signal. This volatility (and other price characteristics) could also change in the future and could be used as a further sampling parameter in future works. A sample trajectory of the resulting two day price signal is given in Fig. 4.2 in the next section.

- *Load demand*

The load demand of the individual household was created as follows. Based on measurements from a distribution grid feeder of CKW (in Ettiswil), a reference trajectory for the aggregate load profile has been identified from the two representative days. The mapping of this aggregated profile to the individual loads of the different distribution grids was performed in two steps.

First, the maximum load at each bus in the grid was determined by solving a grid optimization problem as in Section 3.4.1 with the objective of maximizing the aggregated load of the distribution grid. This results in a reference power at each bus that is at the limit of rendering the distribution grid infeasible and is referred to as high-load situation with  $k_{\text{load}} = 1$ . The other reference power is a low-load situation where all reference power is divided by 2, denoted as  $k_{\text{load}} = 0.5$ .

Secondly, to create the fluctuations over the prediction horizon, the loads were randomly distributed following a normal distribution. The mean of the normal distribution was chosen to be 25% of the reference power. The variance of the normal distribution was chosen to be 50% of the reference power.

This way several loads will saturate at the maximum level (specified in the CKW grid data) and the minimum level (typically zero). After this saturation, some adjustment is needed to meet the measured aggregated profile. The adjustment is evenly distributed between all non-saturated loads of the network.

The resulting load distribution includes a full variation of the load spectrum, on/off situations as well as a certain coincidence factor between the loads. An example time series for the aggregated load profile is shown in Fig. 4.3. The second day is from the winter months and has a significantly higher load demand.

- *Available PV production*

The available PV production was selected to create a challenging RES integration scenario.

First, the maximum PV production level with PV generation at each bus has been identified by solving an optimization problem as in Section 3.4.1 with the objective to maximize the overall PV production. Based on PV radiation data from the region and the two representative days, the maximum installed PV capacity has been scaled to reach the maximum PV production level at the peak hour.

To create the challenging scenario that requires control action or new grid investments to avoid grid constraint violation, this maximum installed PV capacity was *doubled*. Therefore, if no other control actions are taken, part of the available PV production power can not be integrated in the grid and has to be curtailed.

A sample trajectory of the resulting two day PV production level is given in Fig. 4.4 in the next section.

#### 4.4.2 Definition of RES integration strategies

The following alternative approaches for RES integration were preselected and then compared in a quantitative assessment using the optimization and planning tool developed in WP3:

- *Curtailed renewable energies*

In Phase 1, this corresponds to the coordinated curtailment control of the distribution grid's PV panels. Conceptually, the curtailment approach serves as a "slack solution" when the grid operates at one of its limits and the other approaches are not available or not economically

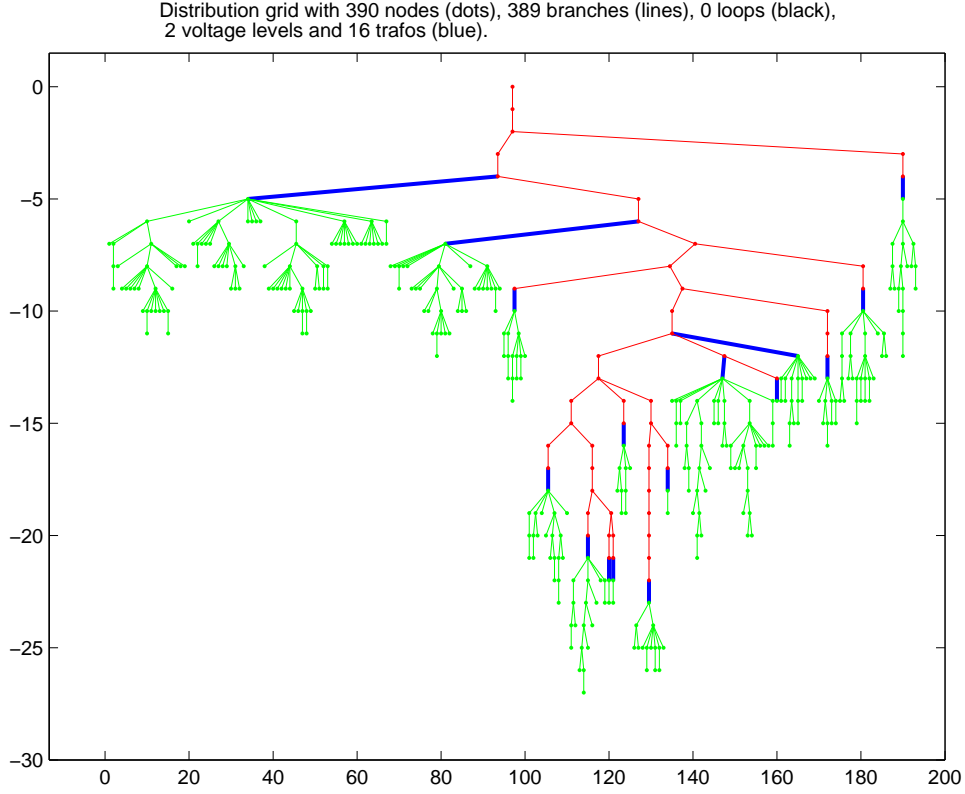

Figure 4.1: Distribution network Sursee-14 as part of the CKW network.

reasonable. The resulting ratio of available PV energy over the optimization horizon that is not used for production is denoted as  $C_{PV}$ . For instance curtailment may be reasonable when the grid meets its limitation only during very days of the year, thereby not justifying a grid reinforcement or the investment in new storage technologies.

- *Use of storage elements.* In Phase 1, this corresponds to the use of batteries with different storage efficiencies and degradation costs. The battery cost model uses the approach of [1] and is given by

$$J = b_{\text{bat}} \bar{E} (SOC - a_{\text{bat}})^2 + c_{\text{bat}} P + d_{\text{bat}} \bar{E} \quad (3)$$

with the storage size  $\bar{E}$ , the State-of-charge  $SOC$  and the charging/discharge power  $P$ . The parameter  $a_{\text{bat}}$  is the optimal state-of-charge (set for instance to 37 % for lithium ion models) while parameters  $\{b_{\text{bat}}, c_{\text{bat}}, d_{\text{bat}}\}$  are sampled for the parametric evaluation. All battery types (lithium-ion, lead-acid, ...) can be mapped to typical point in the parameter space and can be used by the grid operator to compare the results for different investment calculation assumptions.

Conceptually, the optimizer places, sizes (through the variable  $\bar{E}$ ) and uses the storage elements to exploit price differences or to avoid grid contingencies during peak load or peak PV production.

- *Reinforcing and expanding the network.* In Phase 1, the distribution grid reinforcement is modeled as a proportional relaxation of the thermal line constraints and a rescaling of the component impedances. Conceptually,

this corresponds to a global replacement of all grid components in the distribution grid section. The corresponding scaling parameter is denoted  $k_{\text{grid}}$ , taking either the value 1 (no upgrade) or 2 (every network component doubled). This truly simplifying assumption was made to evaluate the potential of grid reinforcements in a tractable approach to obtain an estimate of the potential improvements. In practise, each grid component is evaluated separately and not all components need to be replaced to reach the same level of performance improvement.

- *Use of dispatchable loads.*

In Phase 1, this corresponds to the distribution grid's terminal load, like households, that participate in the demand side management. Conceptually, the loads can reallocate a certain ratio of their daily energy consumption to a different point of the optimization horizon (48 hours in this study). The corresponding ratio is denoted  $k_{\text{DSM}}$ , varying between 0 (no DSM) to 0.3 (30% of the total load energy can be shifted). This allows to reduce congestions during demand peaks or to increase self consumption during production peaks, while keeping the overall energy balance constant.

The use of electrolyzers for the production of hydrogen is analyzed separately in this project phase, to be used as an element at the distribution grid feeder that only depends on the price difference between hydrogen and electricity price.

**Parameter ranges for quantitative RES strategy evaluation** The parametric solution of the optimization problem for the grid planning required sampling of certain system parameters, like the storage costs, electricity price, the maximum use of demand side management and the grid upgrade.

The evaluated samples of the parameter defined in the previous paragraphs are given in Table 4.1. A total of 3456 parameter sample combinations was evaluated, the number results from computing the product of the number of elements in the right table column.

Parameter	Unit	sampled values
grid upgrade factor $k_{\text{grid}}$	-	{ <b>1</b> , 2}
battery SOC reference value $a_{\text{bat}}$	-	{ <b>0.37</b> }
battery SOC cost parameter $b_{\text{bat}}$	CHF/MWh	{ <b>0</b> , 50, 100, 200, 300, 400}
battery power cost parameter $c_{\text{bat}}$	CHF/MW	{ <b>0</b> , 10, 20}
battery fixed cost parameter $d_{\text{bat}}$	CHF/MWh	{ <b>2.5</b> , 5, 10, 20}
average electricity $c_{\text{price}}$	CHF/MWh	{20, 40, <b>80</b> }
demand side management ratio $k_{\text{DSM}}$	-	{0, 0.05, <b>0.10</b> , 0.30}
load profile scaling factor $k_{\text{load}}$	-	{0.5, <b>1</b> }

Table 4.1: Parameter ranges sampled for the benchmark simulations of the grid planning procedure. Parameter values for specific illustrations of Section 4.5.1 is set in bold.

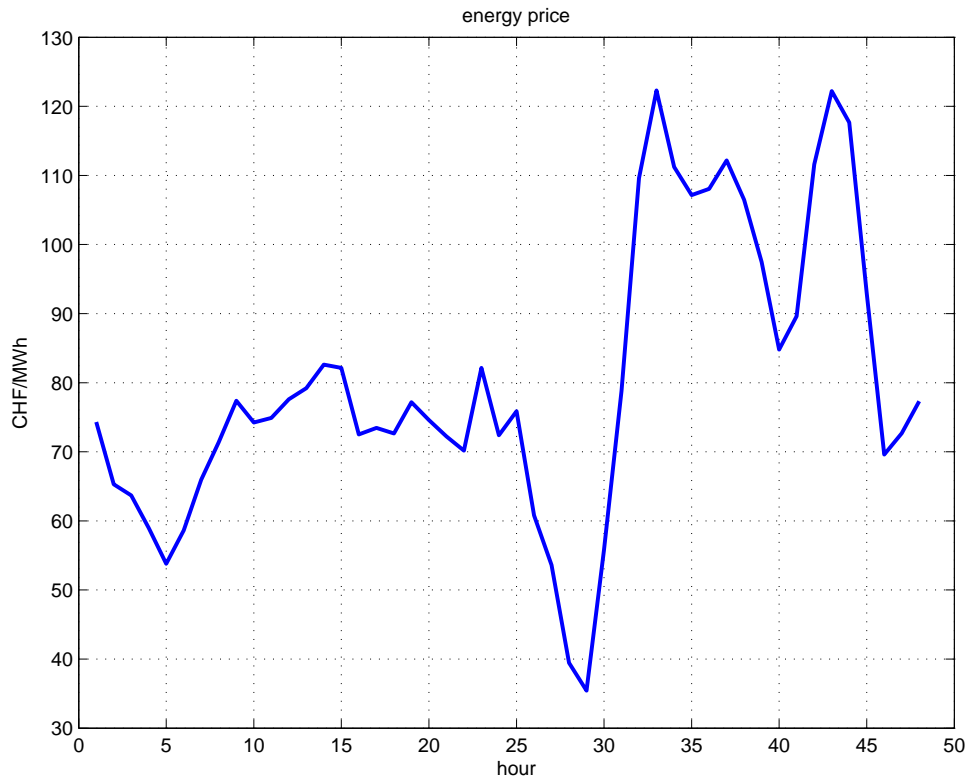

Figure 4.2: Simulation example: Electricity price profile

## 4.5 Results

### 4.5.1 Illustrative example of RES integration approaches.

The following plots illustrates the principle of the different RES integration approaches for a specific parameter set, shown in bold in Table 4.1.

**Input profiles** A high load demand, high electricity price (80 CHF/MWh), small storage costs, no grid upgrade and a medium DSM ratio (10%) was chosen to show the simultaneous cooptimization of curtailment control, DSM control, storage control and storage sizing.

The electricity price profile is assumed to be known to the grid planning algorithm and determines the outcome of the optimization.

The illustrated example profile has a high average electricity price of  $c_{\text{price}} = 80$  CHF/MWh, shown in Fig. 4.2. It consists of 24 hours with low costs and 24 hours with high costs (representing a summer and a winter day).

The time profile of the aggregated load demand of all buses is shown in red in Fig. 4.3.

PV installations of different size are located at all load buses and have a potential PV production that is shown in blue in Fig. 4.4.

**Result profiles** The storage elements are used to dynamically shift load and generation in time to avoid peak productions and grid congestions, resulting in the feeder power shown in blue in Fig. 4.3. The selected charging and discharging profile is a tradeoff between battery degradation, better PV integration and the exploitation of price differences at the feeder.

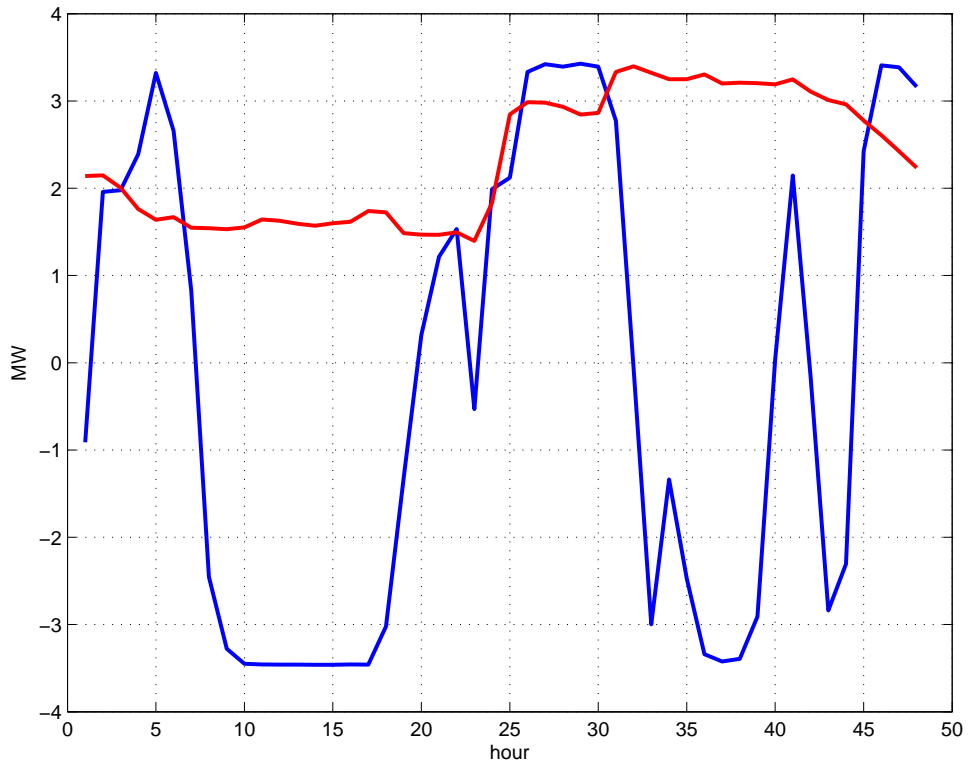

Figure 4.3: Simulation example: Aggregated load demand (red) and feeder power (blue).

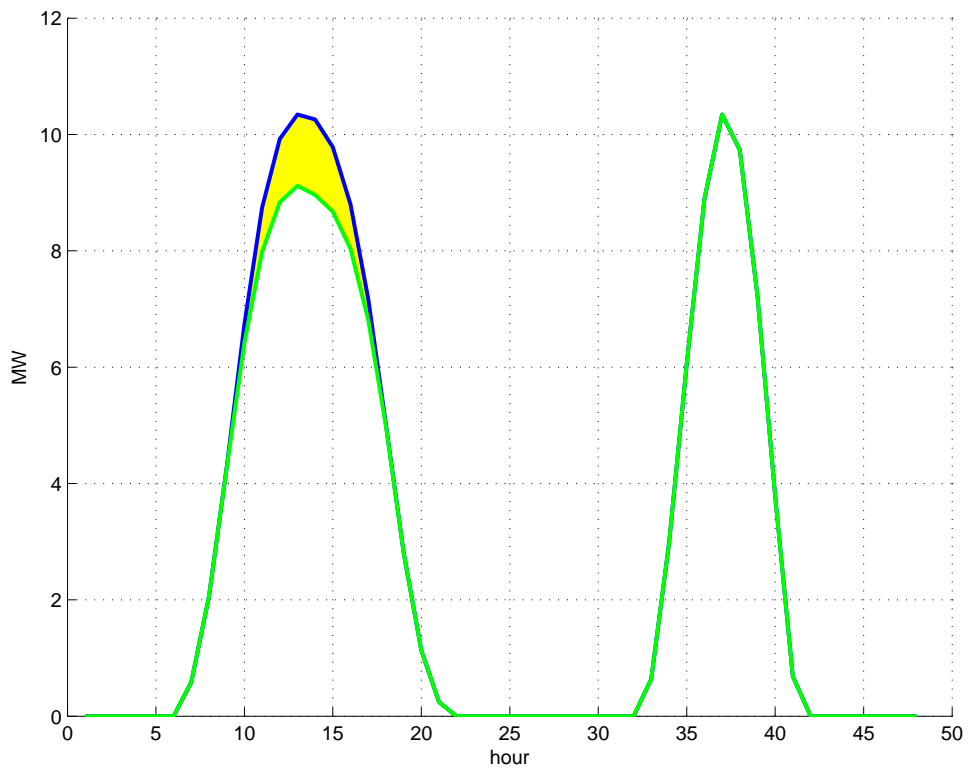

Figure 4.4: Simulation example: Aggregated available PV power (blue), injected PV power (green) and curtailed PV energy (yellow surface).

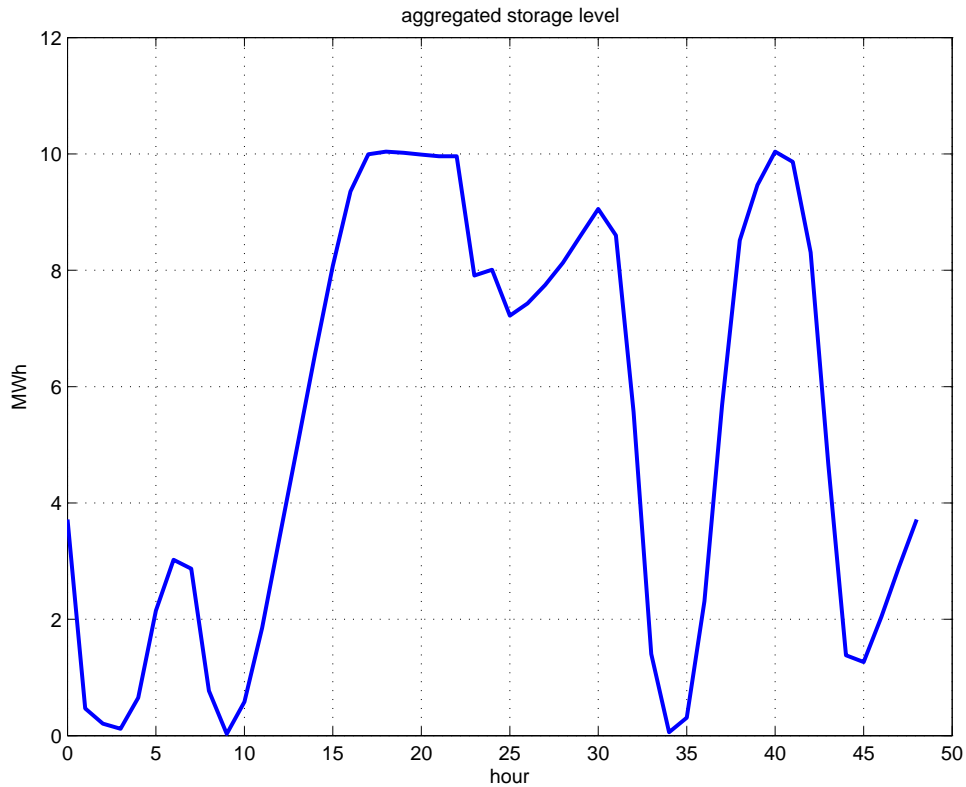

Figure 4.5: Simulation example: Aggregated storage profile at all buses.

Fig. 4.5 shows the aggregated storage energy of all installed Batteries that were chosen and placed by the optimizer (up to 9 MWh). It can be seen that the storages are charged during hours high PV radiation, for instance from 9 hours to 16 hours, when the grid operates at its limit in order to avoid further PV curtailment. The stored energy is discharged during hours of little or no PV radiation to restore the original SOC at the end of the trajectory. The actual PV power production profile and the resulting PV curtailment (that takes place only during the first day) are shown in Fig. 4.4.

The grid planning algorithm also allocates the installed storage capacities. All nodes connected to a PV panel serve as candidate nodes for storage units. The size of the storage at each node is selected to achieve the best overall grid operation cost, i.e. the best tradeoff between RES energy harvesting and storage degradation. The resulting allocation of the storage elements between the buses is shown in Fig. 4.6. In general, larger storage elements tend to be connected to the larger PV installations in the network.

Similar to the storages, demand side management is used to shift the load away from peak hours to avoid congestion. The DSM scheduling result for the given scenario is shown in Fig. 4.7 for an individual load and in Fig. 4.8 for the aggregated effect.

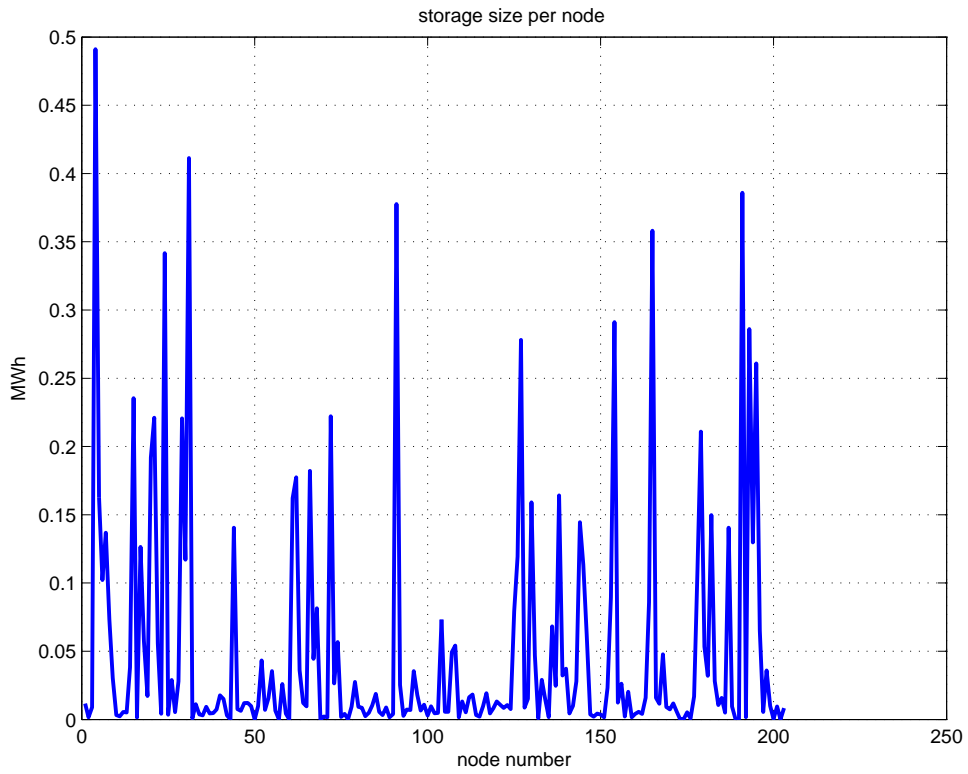

Figure 4.6: Simulation example: Distribution of the storage elements between buses.

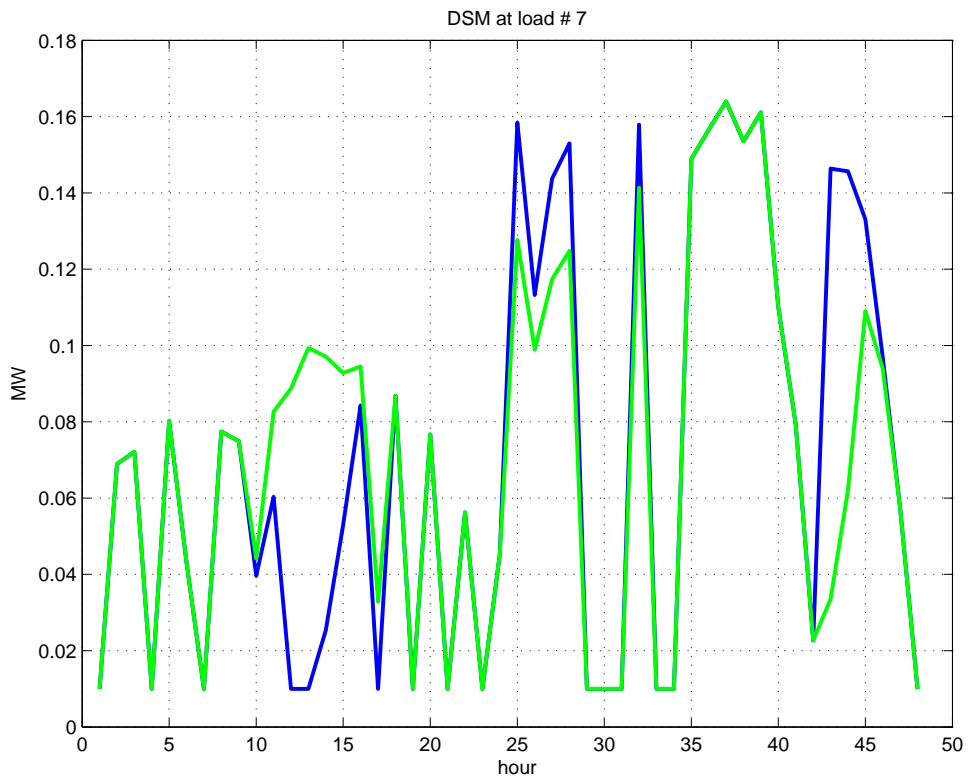

Figure 4.7: Demand side management (blue) and nominal demand (green) at specific bus.



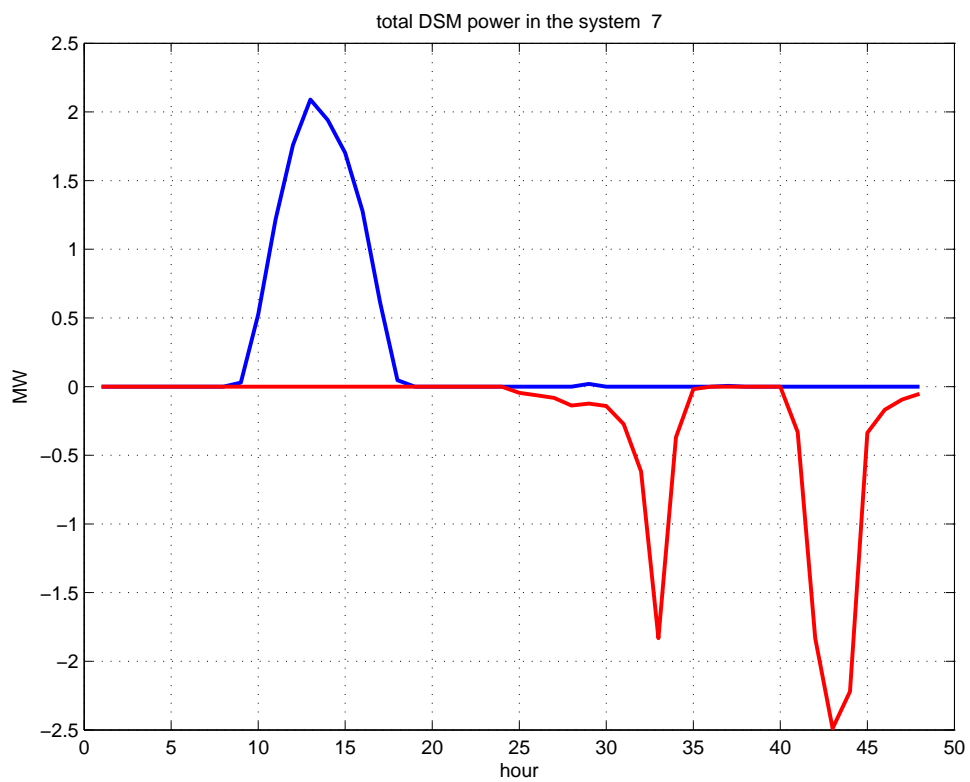

Figure 4.8: Demand side management aggregated over all loads.

#### 4.5.2 Results of analysed RES integration strategies - Base scenario

The base scenario is shown in Table 4.2

Besides PV curtailment, no further RES strategies are used.

	low demand	high demand
Total costs $J$ [CHF]	-554	4430
Curtailment ratio $C_{PV}$	0.3055	0.2345

Table 4.2: Total operational grid costs  $J$  and total curtailment ratio of PV energy  $C_{PV}$  for the base scenario using no storages, no DSM and no grid upgrade. Only PV curtailment is used as a fallback strategy when the grid operates at a technical limit. Results for low and high household demand and different electricity prices.

### 4.5.3 Results of analysed RES integration strategies - The value of storage

This section explores the optimal grid planning results that use storage units to better include RES components into the network. The plots show the sensitivity of the optimization results to different battery cost parameters, electricity prices and demand parameters. The effect of grid upgrades is shown in these plots via dashed trajectories, but is discussed in a separate section. Also, the effect of DSM is not shown in this section.

**Operational costs** First, Fig. 4.9 shows the resulting optimized grid operational costs.

It can be seen in the left column that for low demand scenarios little or no storage units are installed and the operational costs are essentially constant for all battery parameters (on the x-axis and the colours). The costs vary only between the rows of plots, that show different average electricity prices.

The right column of plots shows the result for high demand scenarios. There, storage units are used to reduce the total operational cost of the system. The operational cost however is sensitive to the assumed battery cost parameters and increases along the x-axis and the colours. Besides, these results also vary between the rows of plots, that show different average electricity prices.

**Allocated storage size** Fig. 4.10 shows the corresponding allocated total storage sizes.

The plot makes clear what was mentioned in the previous paragraph: storages are only significantly used for high demand scenarios, show in the right column. The left column of plots shows the low demand scenario, for which only very cheap storage units are an option, with no SOC cost parameter  $b_{\text{bat}} = 0CHF/(MWh \cdot h)$ , and a very low fixed cost parameter  $d_{\text{bat}} = 2.5CHF/(MWh \cdot h)$ . Currently, such storage units are not realistic.

In comparison, the right column of plots shows the high demand scenario. The amount of storage units selected by the optimizer depends on the storage cost parameters. Clearly, less storage is installed for growing fixed cost parameters  $d_{\text{bat}}$ , seen in the trajectories with different colours. An interesting effect can be seen regarding the sensitivity on the SOC cost parameters  $b_{\text{bat}}$ , seen in the trajectories along the x-axis. For increasing SOC costs, larger amounts of storage is installed in the system. The explanation is, that the SOC cost (a quadratic cost function of the SOC) is cheaper if the storages are not fully charged or discharged. Therefore, for higher SOC costs  $b_{\text{bat}}$  (with constant fixed costs  $d_{\text{bat}}$ ) larger storage units are installed to avoid a full charge or discharge of the storage units.

**Curtailement ratio** Fig. 4.11 shows the resulting ratio of total available PV energy that could be harvested with the installed PV panels but is instead curtailed during the operation.

It can be seen that the curtailment ratio is higher during the low demand scenario (left column). In the right column, more PV energy is self-consumed, due to the higher demand at the household buses.

The curtailment ratio decreases in all plots as the battery cost parameters decrease and more storage units are installed. In particular this can be seen for small SOC costs (low  $b_{\text{bat}}$  along the x-axis) and low fixed battery costs (small  $d_{\text{bat}}$  values coloured in blue).

In the shown cases without grid extension (the solid trajectories), the PV curtailment is never totally avoided. The reason is that the grid planning optimization minimizes the sum of energy costs at the feeder and the degradation costs of the storage units. It is more economical to use the PV curtailment controller during a few hours of the reference scenario instead of investing into additional storage units to temporarily store the additional PV energy while the power grid operates at its limit.

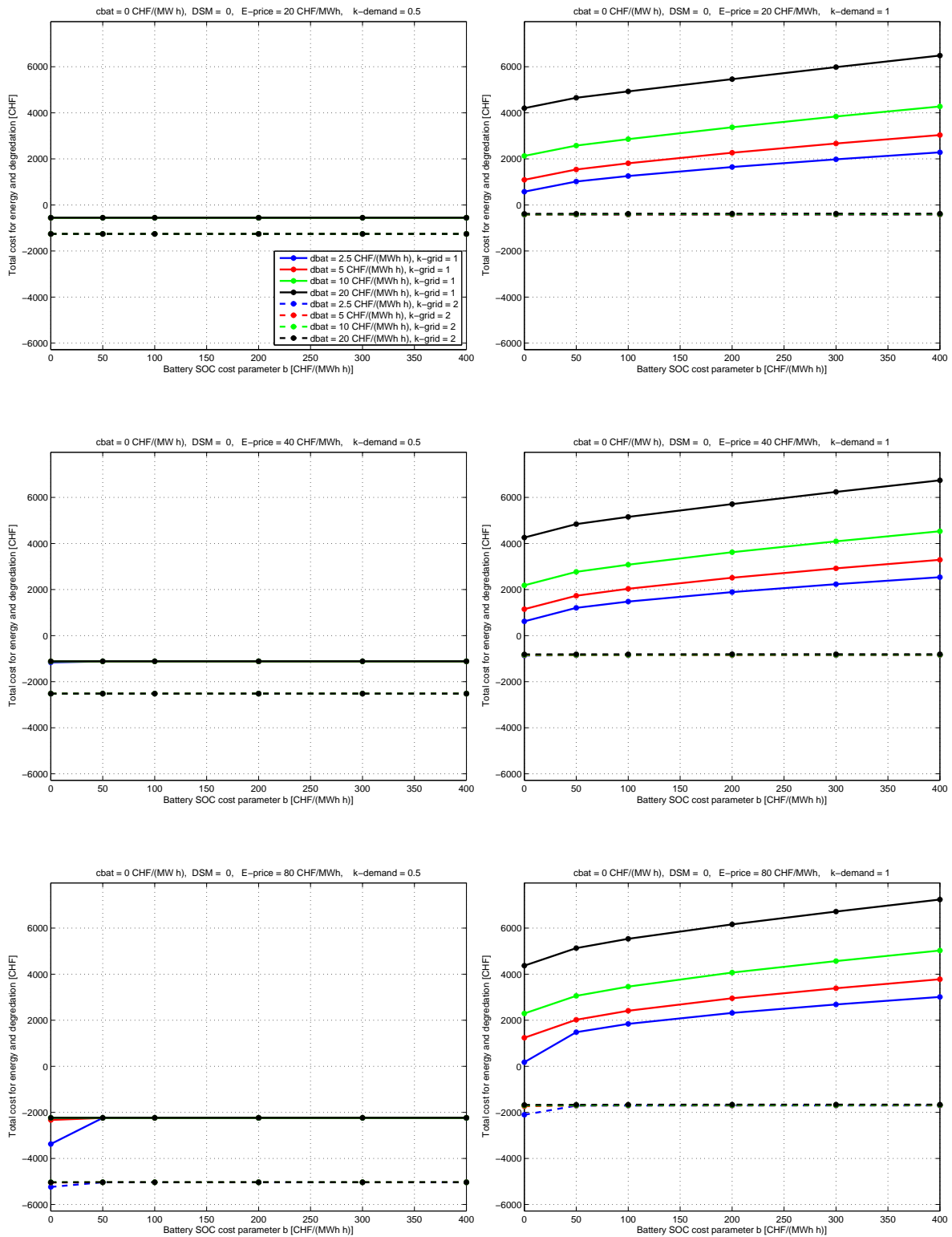

Figure 4.9: **Full operational cost** of the grid reference scenario after optimal storage planning **without DSM**. Low demand (left column) and high demand (right column). Average electricity price of 20 CHF/MWh (top row), 40 CHF/MWh (middle row) and 80 CHF/MWh (bottom row). Results without/with grid upgrade (solid/dashed lines). Results for different battery cost parameters ( $b_{bat}$  on x-axis,  $d_{bat}$  via different colours).

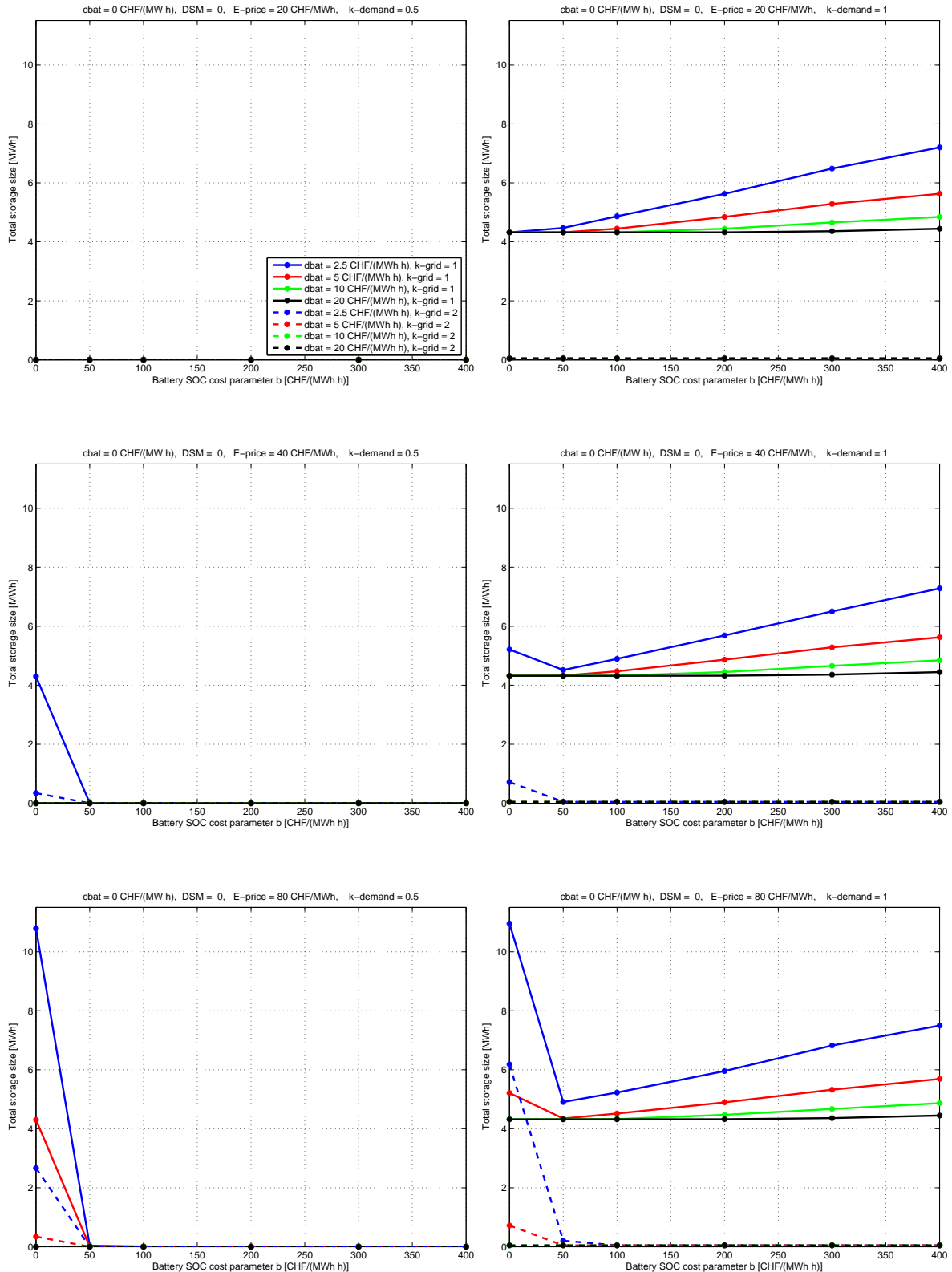

Figure 4.10: **Total allocated storage size** of the grid reference scenario after optimal storage planning **without DSM**. Low demand (left column) and high demand (right column). Average electricity price of 20 CHF/MWh (top row), 40 CHF/MWh (middle row) and 80 CHF/MWh (bottom row). Results without/with grid upgrade (solid/dashed lines). Results for different battery cost parameters ( $b_{bat}$  on x-axis,  $d_{bat}$  via different colours).

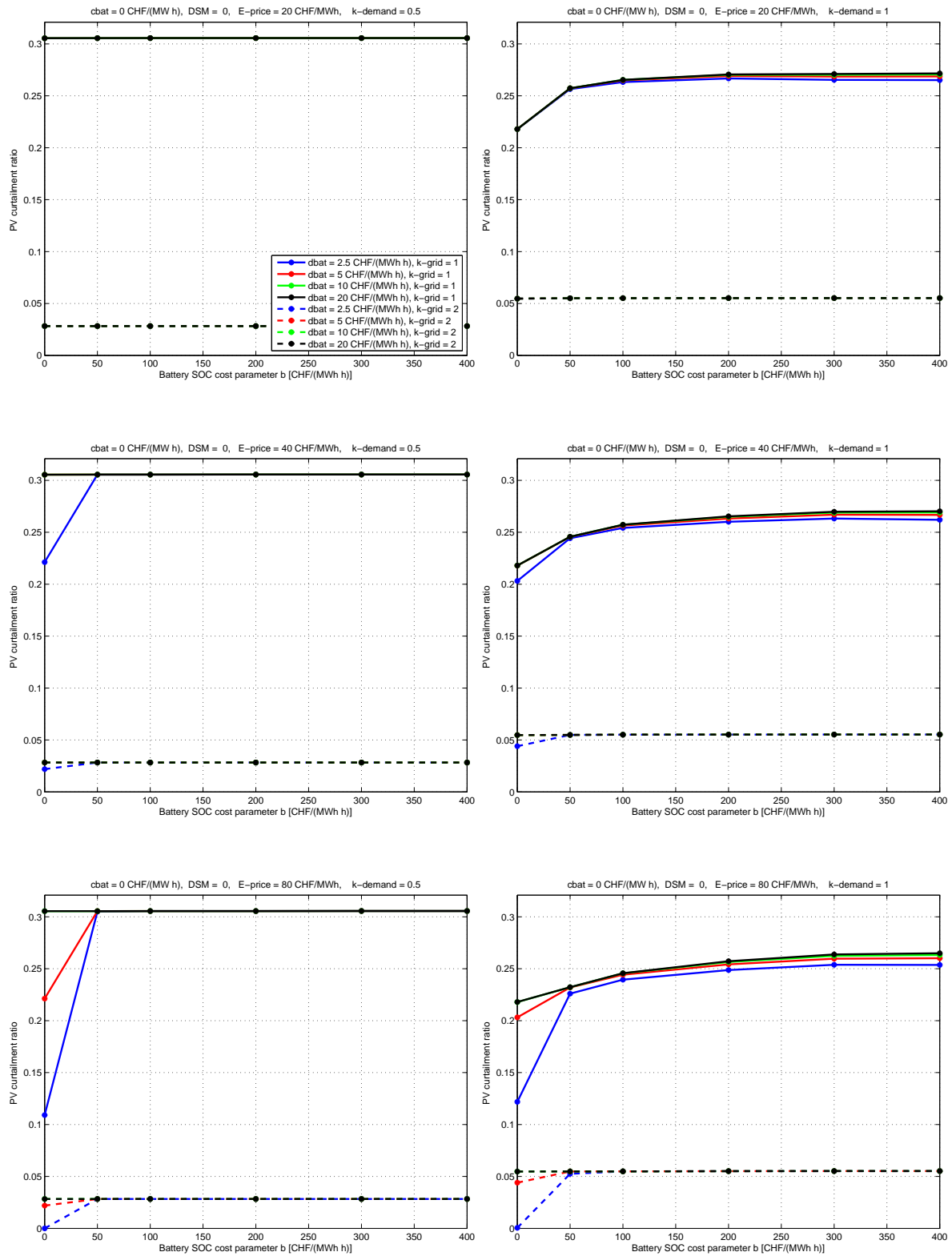

Figure 4.11: **Total RES curtailment ratio** of the grid reference scenario after optimal storage planning **without DSM**. Low demand (left column) and high demand (right column). Average electricity price of 20 CHF/MWh (top row), 40 CHF/MWh (middle row) and 80 CHF/MWh (bottom row). Results without/with grid upgrade (solid/dashed lines). Results for different battery cost parameters ( $b_{bat}$  on x-axis,  $d_{bat}$  via different colours).

#### 4.5.4 Results of analysed RES integration strategies - The value of demand side management

This section explores the optimal grid planning results that use demand side management as an additional strategy besides the storage units to better include RES components into the network. The plots show the sensitivity of the optimization results to different DSM participation ratios  $k_{\text{DSM}}$ . With larger  $k_{\text{DSM}}$ , the system becomes more flexible and can shift more demand power to different times instances of the optimization horizon.

To keep the illustrated results readable, not all battery cost parameters are shown in the plots. In all plots of this section, the battery power cost parameter  $c_{\text{bat}} = 0 \text{ CHF}/(\text{MW} \cdot \text{h})$  and the battery fixed cost parameter  $d_{\text{bat}} = 2.5 \text{ CHF}/(\text{MWh} \cdot \text{h})$  are both set to the lowest value that was investigated. The reason is that DSM has a strong impact on the grid operation. For medium range cost parameters, battery storage is not an economical solution for the investigated scenarios. The low battery cost parameters have been chosen to illustrate the cut off point when battery storage may become economic.

The effect of grid upgrades is shown in these plots via dashed trajectories, but is discussed in a separate section.

**Operational costs** First, Fig. 4.12 shows the resulting optimized grid operational costs.

During low demand scenarios, shown in the left column, the operational costs are mostly constant along the x-axis where little storage units are installed. The operational costs slightly decrease for increasing DSM ratios  $k_{\text{DSM}}$ , since more PV energy can be consumed by the loads during peak PV hours, thereby reducing the required electricity import at a later point in time.

Between the rows of plots, the cost reduction is enhanced by the increasing electricity prices.

The effect is more pronounced for high demand scenarios, since the DSM can now operate with larger power shifts. For example, a 10% DSM participation reduces the total operational costs from  $2000 \text{ CHF}$  to almost zero. A 30% DSM participation factor drives the costs below the value that could be reached with a full rebuild of the network, doubling the AC power transmission capacity. The reason for this reduction is that the allocated storage units are operated in a coordinated way with the DSM controller, to achieve a minimal total operational cost.

In the investigated scenarios, a still moderate DSM participation of the loads in the network can more than replace the cost reduction gained by the use of storage units, even for extremely low storage costs. However, no costs for the DSM participation were included in the optimization. In fact, the difference between the trajectories without DSM (blue) and the trajectories with DSM (other colours) can serve as a guideline how the DSM participation of the customer could be valued by the DSO to reward the possible inconvenience experienced by the customers.

**Allocated storage size** Fig. 4.13 shows the corresponding allocated total storage sizes.

As in the previous section, storages are only significantly used for high demand scenarios, shown in the right column. This result remains unchanged by the addition of DSM controllers to the system structure.

The right column of plots shows the high demand scenario, where the blue trajectory shows the result for cases without DSM control, shown already in the previous section. It can be seen



that the addition of DSM greatly reduces the allocated storage size. For example, a 5% DSM participation in a high demand scenario (red lines in the right column of plots) reduces the allocated storage size by more than a factor of 2.

The effect of increasing storage sizes with increasing SOC cost parameters  $b_{\text{bat}}$  that was described in the previous section is also present in the cases with DSM participation.

**Curtailement ratio** Fig. 4.14 shows the resulting ratio of total available PV energy that could be harvested with the installed PV panels but is instead curtailed during the operation.

The plots confirm what was mentioned in the previous paragraph: DSM greatly reduces the curtailed PV energy by shifting load towards the hours of peak PV injection. For example, a DSM participation of  $k_{\text{DSM}} = 30\%$  cuts the PV curtailement roughly by a factor of 2 for low demand scenarios (left column of plots) and a factor of 4 for high demand scenarios (right column of plots).

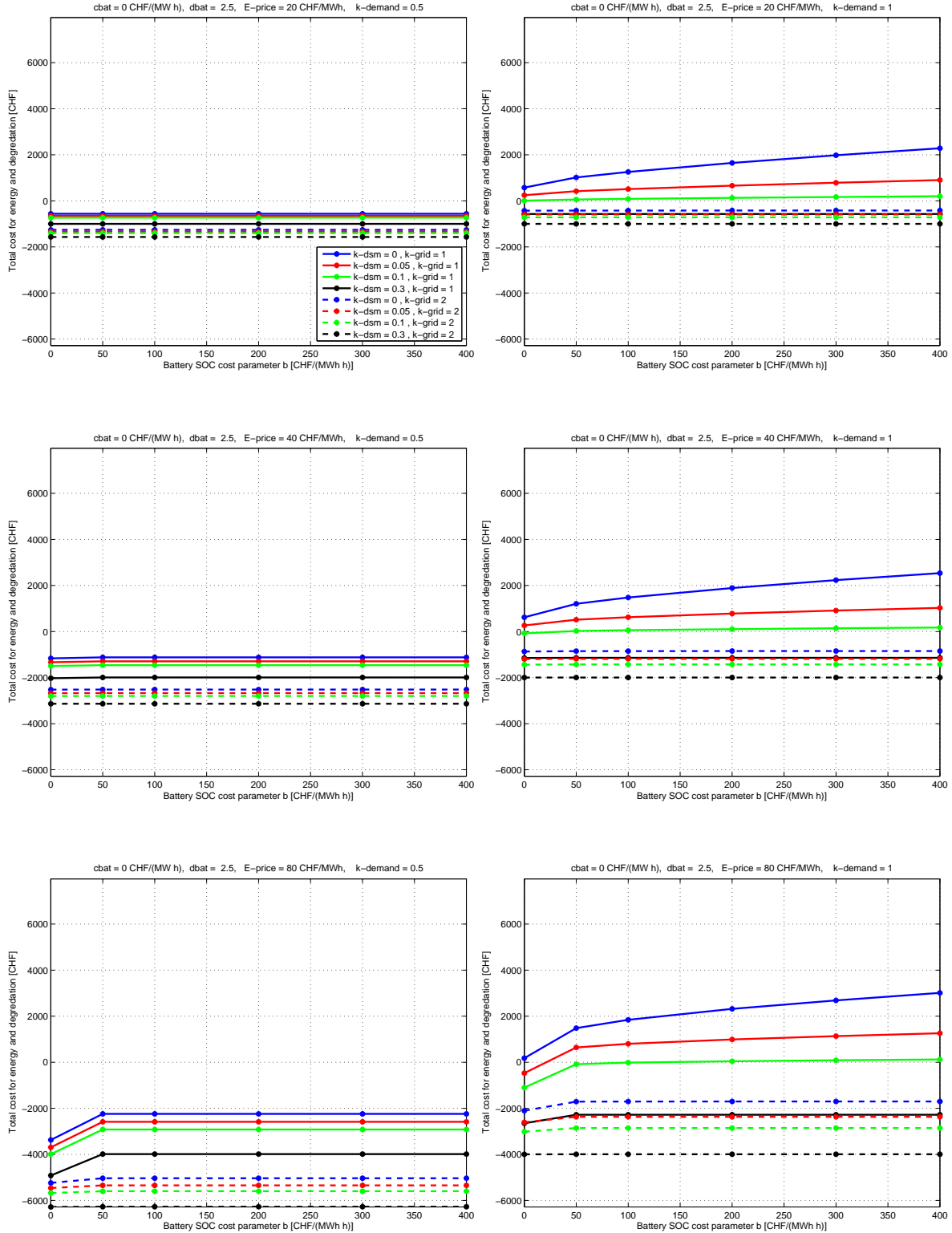

Figure 4.12: **Full operational cost** of the grid reference scenario after optimal storage planning **with constant fixed battery costs**  $d_{\text{bat}}$ . Low demand (left column) and high demand (right column). Average electricity price of 20 CHF/MWh (top row), 40 CHF/MWh (middle row) and 80 CHF/MWh (bottom row). Results without/with grid upgrade (solid/dashed lines). Results for different battery cost parameters ( $b_{\text{bat}}$  on x-axis) and different DSM participation ratios ( $k_{\text{DSM}}$  via different colours).

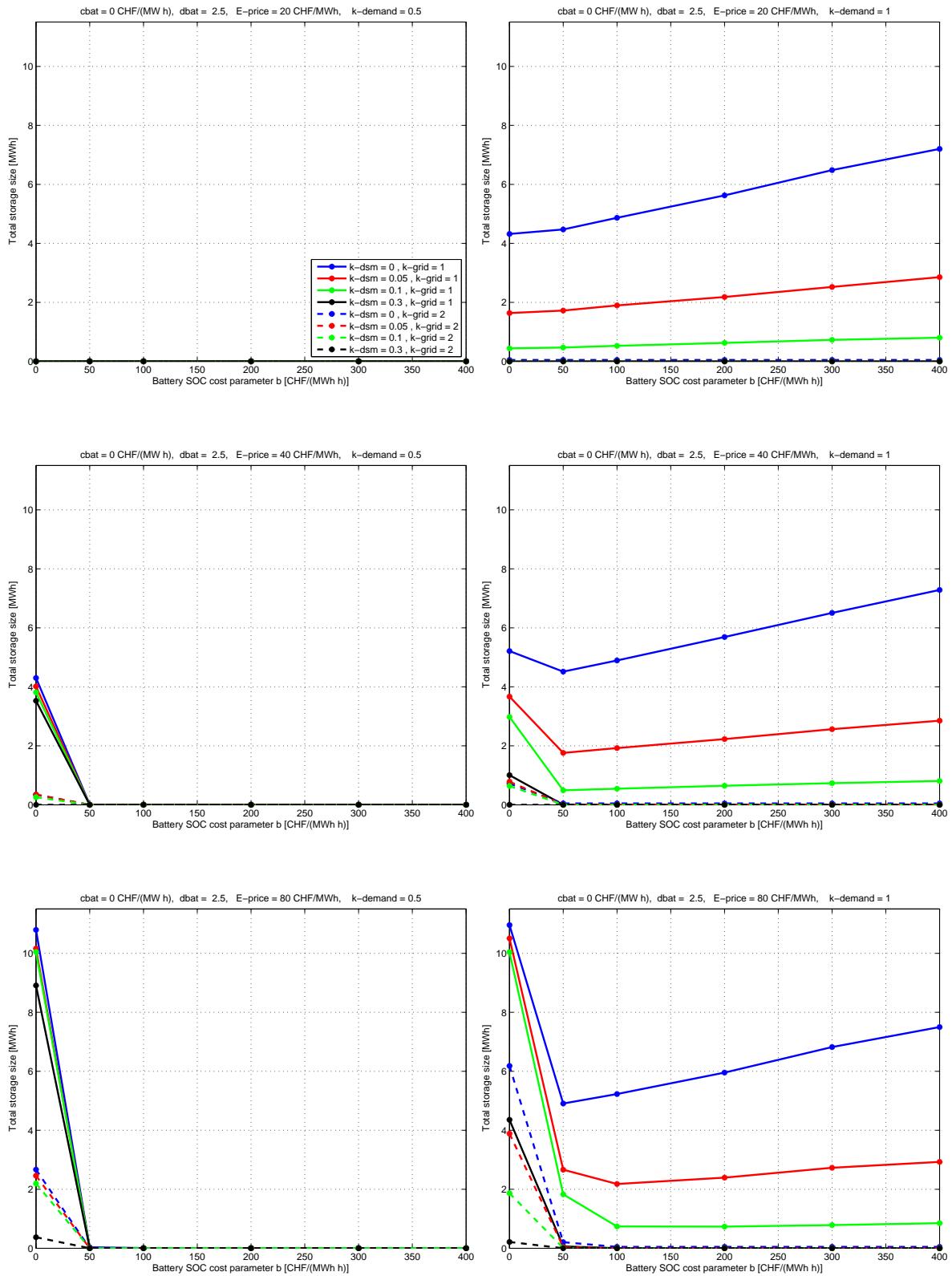

Figure 4.13: **Total allocated storage size** of the grid reference scenario after optimal storage planning with constant fixed battery costs  $d_{bat}$ . Low demand (left column) and high demand (right column). Average electricity price of 20 CHF/MWh (top row), 40 CHF/MWh (middle row) and 80 CHF/MWh (bottom row). Results without/with grid upgrade (solid/dashed lines). Results for different battery cost parameters ( $b_{bat}$  on x-axis) and different DSM participation ratios ( $k_{DSM}$  via different colours).

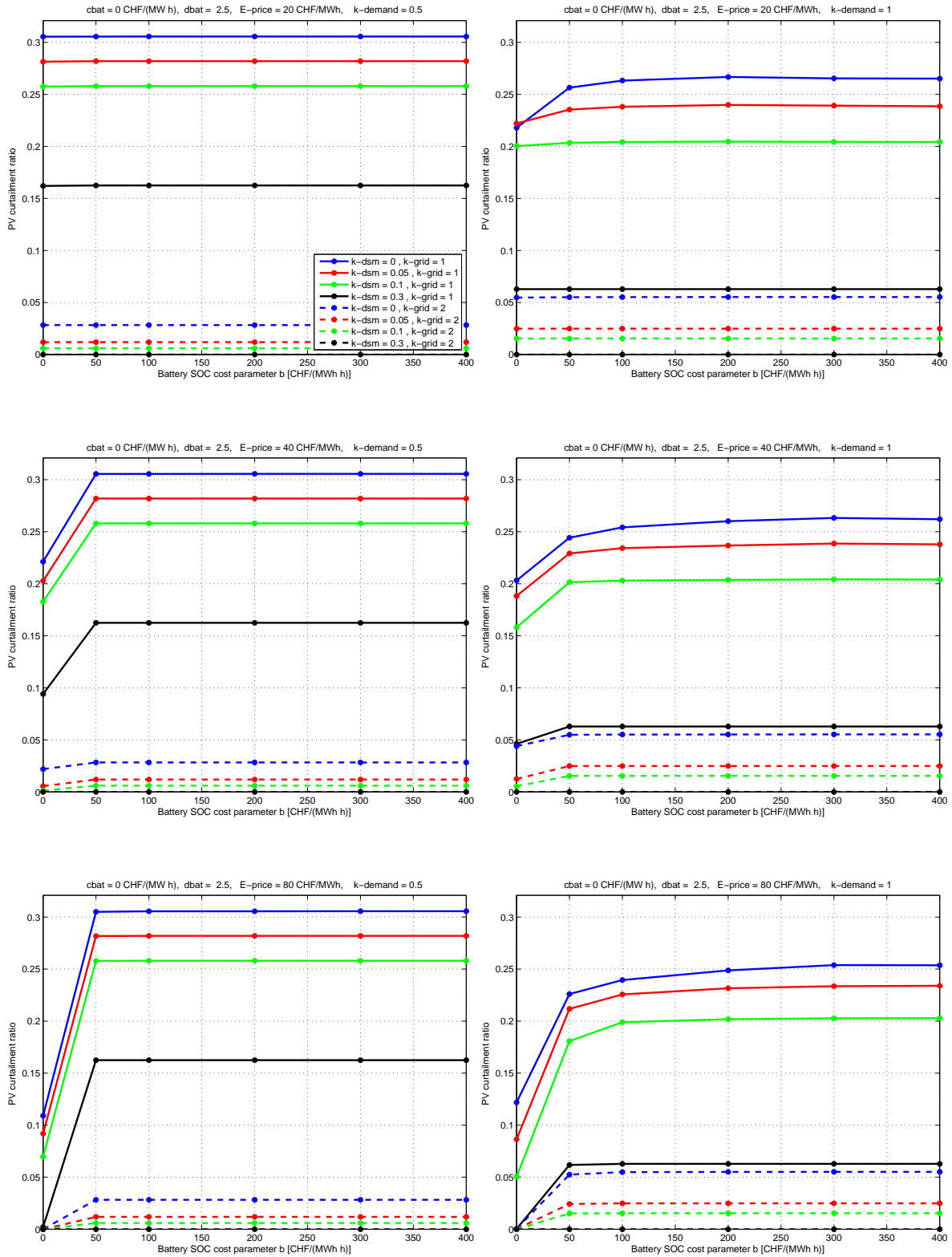

Figure 4.14: **Total RES curtailment ratio** of the grid reference scenario after optimal storage planning with constant fixed battery costs  $d_{\text{bat}}$ . Low demand (left column) and high demand (right column). Average electricity price of 20 CHF/MWh (top row), 40 CHF/MWh (middle row) and 80 CHF/MWh (bottom row). Results without/with grid upgrade (solid/dashed lines). Results for different battery cost parameters ( $b_{\text{bat}}$  on x-axis) and different DSM participation ratios ( $k_{\text{DSM}}$  via different colours).

#### 4.5.5 Results of analysed RES integration strategies - The value of grid expansion

This section explores how the optimal grid planning results are altered when the entire network (lines and transformers) are upgraded by a factor of 2, thereby increasing the thermal limits and reducing the voltage drops of the system during a given load scenario.

The results for cases with grid expansion is indicated in all plots of Fig. 4.9 to Fig. 4.14 by dashed trajectories.

**Operational costs** As for DSM, the strategy of grid upgrade has no explicit cost that contributes to the objective function of the planning optimization. If the degradation of the AC distribution grid can be modeled as usage independent (same life time of the lines, whether they are loaded high or low), the investment decision can be derived directly from the plots.

For instance during a high demand scenario with no DSM, electricity costs of 40 CHF/MWh and battery costs of  $b_{\text{bat}} = 200 \text{ CHF}/(\text{MWh}\cdot\text{h})$ ,  $c_{\text{bat}} = 0 \text{ CHF}/(\text{MW}\cdot\text{h})$  and  $d_{\text{bat}} = 20 \text{ CHF}/(\text{MWh}\cdot\text{h})$  the operational costs are shown in the center right plot of Fig. 4.9. An upgrade of the distribution grid would be economically reasonable if the cost reduction from about 6000 CHF to -1000 CHF covers the additional degradation costs of the upgraded network during one optimization interval (in this case 48 hours).

Of course, these numbers serve only as indicator. Not all parts of the network need to be simultaneously upgraded by the same factor. Furthermore, a usage dependent degradation of the upgraded network would require a modeling of this degradation in the problem formulation, which is not possible with the shown method and optimization tool.

**Allocated storage size** Upgrading the distribution grid is a very strong measure. In most cases, a network upgrade completely removes the need for storage units during the network planning optimization (see Fig. 4.10 and Fig. 4.13). Exceptions are only the cases with extremely low storage cost parameters.

The result is the same for cases with or without DSM.

**Curtailement ratio** Upgrading the distribution grid is a very strong measure that often greatly reduces the need for PV curtailment or can even, in the case of DSM participation (see Fig. 4.14), eliminate the need for curtailment altogether.

## 4.6 Conclusions

The following general conclusions are drawn from the quantitative simulation study.

1. *Storage is only economic for higher electricity prices or lower storage costs than today.*

For low demand scenarios, storage units are only economic for extremely low battery cost parameters. The cut off point is at the lower end of the sampled parameters during the optimization. For high demand scenarios with little or no DSM, storage units can become an economic approach that reduce the curtailment of the PV energy.

2. *Grid upgrade evaluation depends on the calculation costs of the grid operator.*

The concrete costs of all network components were not evaluated. However, if the calculation cost of the grid component is known, for instance by the DSO evaluating the investment decision for the upgrade, the number can be compared to the potential gain from the reduced operating costs of the system, as shown in Section 4.5.5.

3. *Economically, curtailment is in almost all scenarios reasonable to some extent.*

The controllability of the PV components models the curtailment of available PV energy that would overload parts of the network. In the study, this approach served as a fallback option when the network became overloaded. The costs were not explicitly modeled but resulted from the opportunity costs of not injecting the available energy.

4. *Large potential of controllable loads.*

A strong reduction of the system operating costs can be reached if parts of the nominal load demands can be shifted in time by the DSO. The benefit from such a DSM procedure is the reduced overall system costs. In a highly loaded and potentially congested network the reservation of even just 10% of the daily load demand to smart rescheduling creates a gain that would quickly offset any hardware investment costs. The difficulty lies rather in the operational procedures and interactions with the customers, that need to be altered.

## 4.7 Future Work

The simulation analysis should be extended to a real world business case study of a distribution grid participant involving the current regulatory constraints, ownership aspects and grid utilization costs. Furthermore, environmental aspects based on the LCA performed in WP2 should be coupled with or integrated in the simulation analysis. This concerns an optimization for specific environmental indicators such as life cycle greenhouse gas emissions, identification of most beneficial RES integration strategies from the environmental perspective and identification of trade-offs between costs and life cycle burdens.

## References

- [1] P. Fortenbacher, J.L. Mathieu, and G. Andersson. "Modeling, identification, and optimal control of batteries for power system applications". In: *Power Systems Computation Conference (PSCC), 2014*. Aug. 2014, pp. 1–7.

## 5 WP5: National Electricity Grid Model

### 5.1 Introduction

This workpackage develops the framework for the national grid modeling for the study of renewable energy source (RES) in Switzerland on the national level. The study of future electricity production scenarios on a Swiss national level is carried out by EEG. The complexity of the scenario studies requires a simplified representation of the network using a reduced number of grid states with a reduced number of grid constraints. This section outlines the model reduction procedure developed at FEN for the purpose of this study.

### 5.2 Objectives

The goal of this work package is, to provide sufficiently small yet secure network model for EEG to integrate in their STEM-E planning simulations [1].

### 5.3 Scope

The activities in WP5 focused on four topics:

1. Reduction of detailed grid models to aggregated models and the impact on security constraints
2. Interfacing the FEN model and EEG STEM-E model
3. Verification of EEG study results in the FEN model

The presented method is also outlined in [2].

### 5.4 Methodology – Secure aggregation of detailed grid models

The primary source of grid constraints in multi-area power system arises from thermal line limits in the network branches and voltage bounds at the network nodes. As a first approximation, focusing on the thermal line limits, the power flows in the network are modeled using a DC power flow model. In this modeling approach, the network flow is fully determined by the net power injections into the  $n$  nodes of the network, denoted by the vector  $x$  of length  $n$ . Then the full line flows are determined through the power transfer distribution matrix  $H$  [3], yielding

$$x_{min} \leq Hx \leq x_{max} \quad (4)$$

with the vector of maximum line loadings  $x_{max}$  and  $x_{min} = -x_{max}$ . An injection vector  $x$  satisfying these inequalities violates no line limits and is considered *safe*.

The network reduction consists of aggregating the network into  $m$  region, each represented by a single node, with  $m \ll n$ . The outcome is a reduced power system model with the vector  $y$  denoting the total aggregated net power injections of the regions. The transformation with the *bus aggregation matrix*  $T$

$$y = Tx \quad (5)$$

is essentially a summation of the net power injections of all buses associated with a region. If the original bus  $i$  is assigned to region  $j$ , then the element of  $T$  in column  $i$  and row  $j$  is 1, and zero otherwise.

To carry out studies in the reduced model and the observed limitations should have a valid interpretation in the original detailed model. To this end, the linear aggregation map (Eq:5) can provide different representations of the constraints (Eq:4) in the reduced state space.

On the one hand, a direct projection of the constraints set (Eq:5) to the reduced space provides a convex set defining a *weak* safe set, for which any safe reduced state has *some* safe state in the original model. On the one hand, a *strong* safe set can be defined by the reduced states  $y$  for which *all* corresponding states in the original model are safe. Both of these sets represent two extreme case that are overly optimistic (the weak safe set) or overly strict (the strong safe set). Furthermore, both extreme sets are hard to compute for large detailed network models.

Therefore a compromise has been chose that is simple to compute and provides a set smaller than the optimistic weak safe set and the stricter strong safe set. The key is that the approach uses a fixed disaggregation  $D$  of the reduced network injections  $y$  to the detailed network injections  $x$ , with

$$x = Dy \tag{6}$$

and  $D \cdot T = I$ . The reduced network constraints then become

$$x_{min} \leq HDy \leq x_{max} \tag{7}$$

Note that the disaggregation  $D$  is not unique, since there are infinite ways in which an aggregated power injection can be distributed between multiple nodes of a network. For the preparation of the EEG model,  $D$  was selected to allocate power injections according to the original distribution of generation capacity in the detailed base model.

The approach is illustrated in Fig. 5.1 and Fig. 5.2 for a simple system of six nodes. It features illustration of the generator capacities (red), the weak feasible set and the strong feasible set.

## 5.5 Results

### 5.5.1 Interfacing the FEN model to the EEG model

The first part of the interface between the FEN and the EEG model consists of the representation of the FEN network model in the EEG simulation framework. To this end, the aggregation approach has been used to generate a reduced network model based on the following input parameters:

- A detailed network model. This model is an AC load flow model of Switzerland and the surrounding countries. It has been developed within the related projects at FEN, namely the NFP projects AFEM and is also used within a subproject of SCCER-FURIES. The model has 231 nodes, 439 lines and serves as an input to the aggregation framework.
- The allocaton of the nodes to the region is done according to the kantonal aggregation into 7 regions, as illustrated in the EEG section.



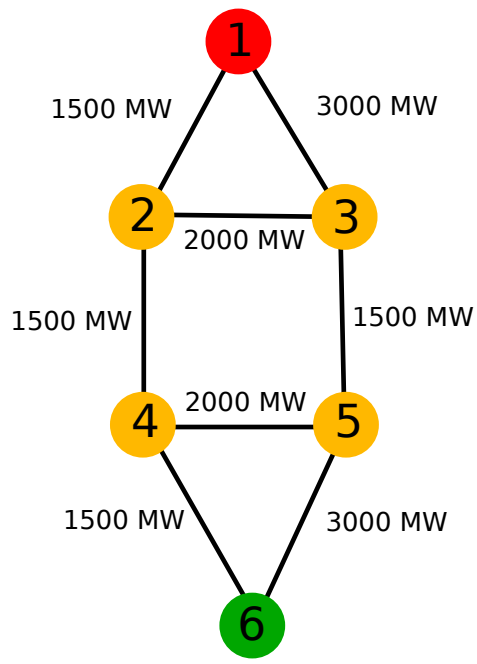

Figure 5.1: Topology of the six bus example system, showing bus numbers and line constraints. The nodes 2-5 are aggregated into the center region. The demand power at node 6 is 4 GW, at all other nodes 3 GW. The maximum generation power at nodes 1 and 4 is 6 GW, at all other nodes 3 GW.

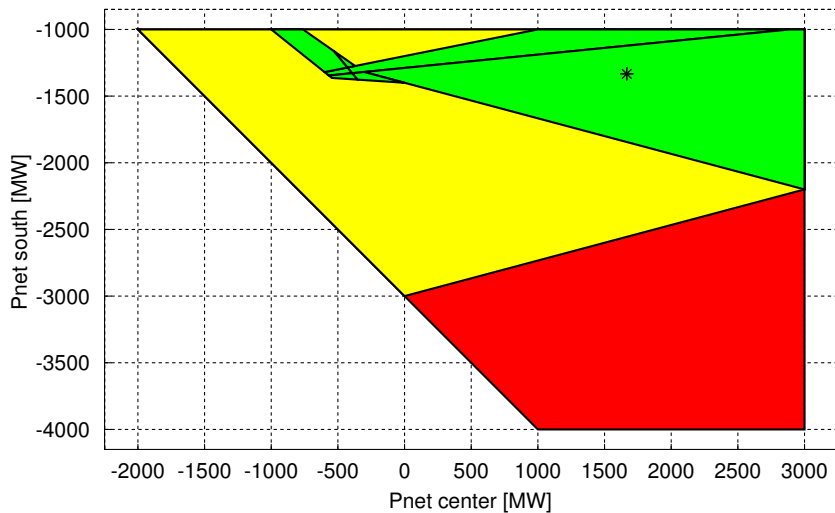

Figure 5.2: Six bus system with increased transmission capacity aggregated into three regions. Possible net power injections in the center and southern region after dispatch (star). Generator constraints (red), line constraints (yellow) and strong feasibility constraints (green). The intermediate set is convex and lies between the yellow and the green area.

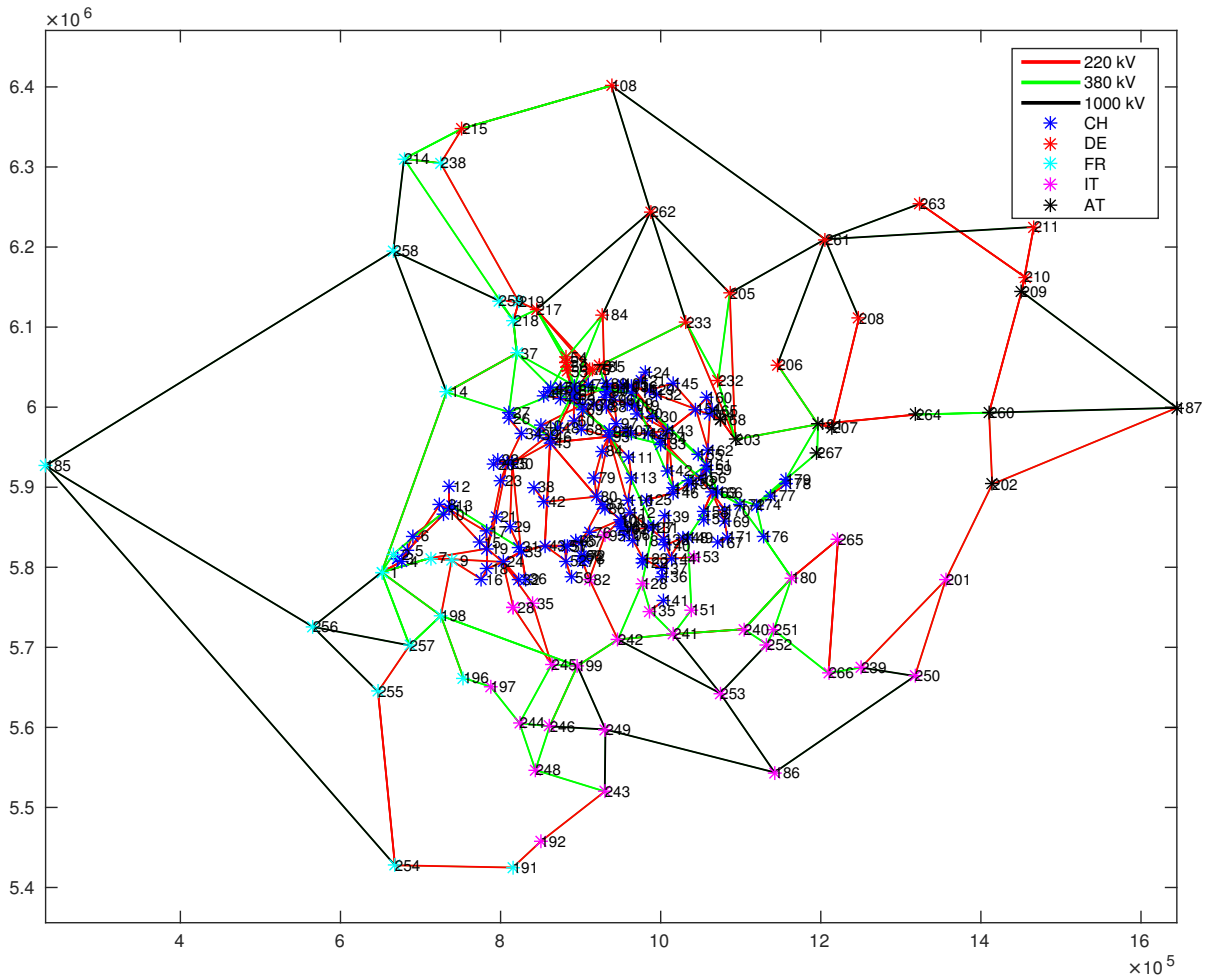

Figure 5.3: Illustration of the detailed network model with 231 nodes and 439 lines.

- In addition to the 7 regions, 4 additional regions are added for the European neighbors. Each region has a separate variable for generation and demand. Furthermore, 4 variables are used to model the injection of the 4 Swiss nuclear power plants independently. This yields a total of  $2 \cdot (7 + 4) + 4 = 26$  variables in the injection vector  $x$ .
- The resulting constraint parameters  $\{H \cdot D, x_{max}, T\}$  have been exported to csv-format and provided to EEG for implementation in their GAMS model.

### 5.5.2 Verification of EEG study results in the FEN model

The studies of EEG result in scenario dependent time series of the aggregated vector  $y$  as well as indicators which constraints of  $x_{max}$  were limiting. Furthermore scenarios with newly installed generation capacities provide an update to the generation limits in each region. Typical scenarios include possible production allocations during future years under different boundary conditions (increased demand, nuclear phase out). The validation of these EEG study results in the FEN model includes the following steps:

1. Reading the time series data, allocating the results to the reduced injection vector  $y$ .

2. Verification of the line limit constraints (Eq:7) (based on the linear DC load flow).
3. Disaggregation to the detailed injection vector  $x$ , verification of the nonlinear line limits and voltage constraints (using the original AC load flow model)
4. Feedback to EEG of current bottlenecks, possible line extensions or injection changes.
5. Illustration of the results.

## 5.6 Conclusions

This workpackage outlined the approach used to provide sufficiently small yet secure network model for EEG to integrate in their STEM-E planning simulations. The result uses a 7 region model of Switzerland with distinct hydro generation, demand and nuclear generation variables as well as the four neighboring countries.

## 5.7 Future Work

A future extension should consider different disaggregation approaches and could consider network state dependent linearizations for a local and more accurate analysis of the obtained results.

## References

- [1] R. Kannan and H. Turton. *Switzerland energy transition scenarios - development and application of the Swiss TIMES Energy system Model (STEM)*. Report. 2014.
- [2] Alexander Fuchs, Marc Scherer, and Göran Andersson. "Polyhedral Computation Based Transfer Capacities in Multi-Area Power Systems". In: *arxiv* arXiv:1511.00435 (2015).
- [3] J. Machowski, J.W. Bialek, and J.R. Bumby. *Power System Dynamics: Stability and Control*. John Wiley & Sons, Ltd., 2008.

## **6 WP6: Energy system modeling**

### **6.1 Introduction**

In WP6, the Swiss TIMES Energy Systems Model (STEM) [1] is the core analytical tool. Within the framework of this project, the electricity supply and the industry, commercial, residential sectors of the STEM model have been further developed to incorporate an appropriate (high-level) representation of the electricity grid. A part of this model development was a spillover from the “System modelling for assessing the potential of decentralized biomass combined heat and power plants (CHP) to stabilize the Swiss electricity network with increased fluctuating renewable generation (CHP SWARM)” project funded by SER and BFE [2, 3].

In addition, the technology database of the model, especially with regards to electricity storage options, was improved based on the output of WP2.

### **6.2 Objectives**

The objective of this WP is to prepare the STEM model for integrating the electricity grid model in Section 7 and for performing the national scenario analysis in WP8. To this end, the work in Section 6 focused on overcoming the main limitations of the electricity module of STEM, in view of assessing the barriers and benefits of further deployment of non-hydro renewable electricity generation, and the different renewable integration strategies. The limitations in the original STEM structure include: a) lack of electricity storage options other than pump hydro storage; b) lack of representation of different grid voltage levels in order to better distinguish between transmission and distribution grid, and consequently between large-scale and distributed generation; and c) inadequate representation of the temporal stochastic variability of renewables. Therefore, in order to be able to facilitate the work in Section 7 and ensure consistency with the more detailed electricity grid modelling in WP8, it was deemed necessary to address these limitations, by improving the electricity module of the STEM model and enriching its technology database with additional electricity storage options.

### **6.3 Scope**

Section 6 has two main sub-tasks. Task 6.1 deals with improving and enriching the technology database of the STEM model based on the technology assessment of electricity storage and electrolyzers options performed in Task 2.1 (WP2). A selection of the technologies identified and characterized in Task 2.1 was included in the model based on different sizes, scope of application and ability to provide storage services at different temporal scales. Dispatchable loads, such as water heaters, heat pumps and electrolyzers, were also included at different sizes and scope of application too.

Task 6.2 involves the structural developments in the electricity supply module of STEM and equipping it with appropriate mechanisms/features in order to be able to perform assessment of different renewable integration strategies. The most important new features added into the model are: a) representation of transmission and distribution grid, and consequently representation of large-scale and distributed generation; b) introduction of temporal variability of electricity

supply and electricity demand; c) representation of markets for grid balancing services; and d) representation of power-to-hydrogen and power-to-gas pathways.

The improvement of the model's technology database and the structural developments in the electricity module of STEM are described in detailed in the next section.

## 6.4 Methodology

### 6.4.1 Improving the technology database of the STEM model

The electricity storage technologies identified in WP2 Task 2.1 are included in STEM. Additional electricity storage options at different scales and for different applications, not covered in WP2, are also included in the model based on techno-economic characterization from publicly available sources [4]. They include:

- **Large scale electricity storage:** pump hydro storage and compressed air energy storage (CAES); these options are assumed to be connected to very high and high voltage grid levels (36 – 220/380 kV).
- **Medium – to large scale electricity storage:** Lead-acid batteries, Sodium-sulfur (NaS) batteries, Vanadium redox flow batteries (VRFB); these options are assumed to be connected to high and medium voltage grid levels (1 – 150 kV).
- **Small – to medium scale electricity storage:** Lead-acid batteries, NaS batteries, VRB batteries, Lithium-ion batteries (Li-Ion) and Nickel-metal hydride batteries (NiMH); these options are assumed to be connected to medium and low voltage grid levels (0.4 – 36 kV).
- **Micro – to small electricity storage:** Lead-acid batteries, Li-Ion batteries and NiMH batteries; these options are assumed to be connected to the low voltage grid level (0.4 – 1 kV).

The above electricity storage technologies are differentiated according to their ability to operate at different temporal scales. For example, pumped hydro can be considered to provide monthly, weekly, daily and hourly storage. CAES can be considered to be applicable for weekly, daily and hourly storage. On the other hand, batteries mainly provide daily and hourly storage [5].

The model database has been also extended to include dispatchable loads, such as electrolyzers, water heaters and heat pumps. The technical-economic characterization of these technologies is taken from WP2 with complementary technical and cost data from other sources [5]. The following dispatchable loads were included in STEM, differentiated by scope of application:

- **Large scale dispatchable loads:** PEM electrolyzers; these are assumed to be connected to the high voltage grid level.
- **Medium scale dispatchable loads:** PEM electrolyzers, heat pumps and water heaters in industrial facilities; these are assumed to be connected to the medium voltage level.
- **Small- and micro scale dispatchable loads:** heat pumps and water heaters in commercial and residential buildings; these are assumed to be connected to the low voltage level.

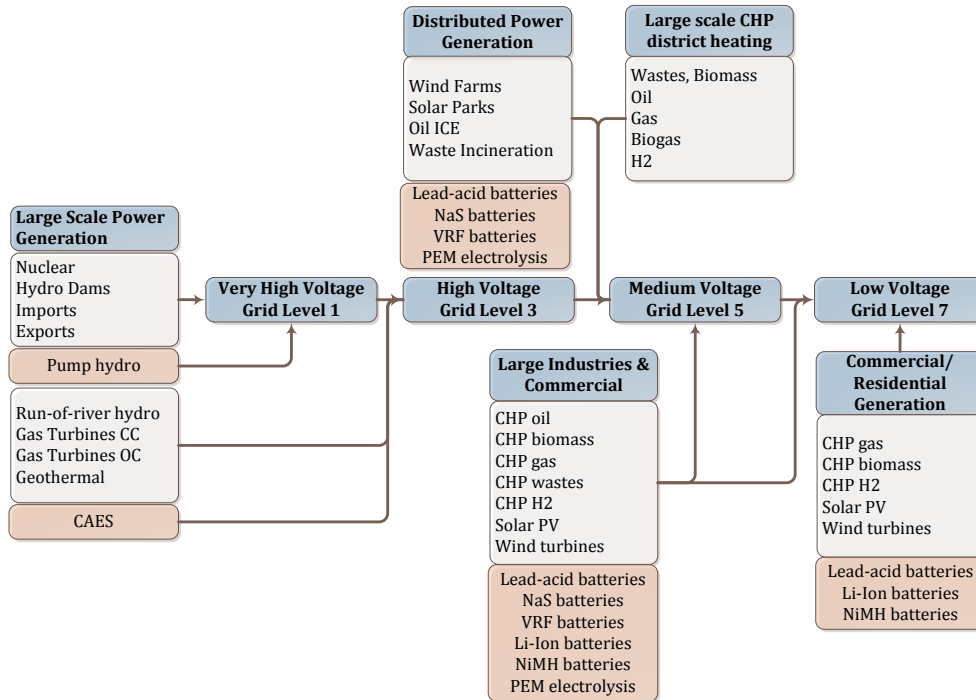

Figure 6.1: Overview of the enhanced representation of the electricity sector in the STEM model

#### 6.4.2 Improving the structure of the STEM model

The electricity supply module of STEM was restructured to distinguish among the different grid voltage levels. Further, new equations were included in the model for representing the temporal variability of renewable electricity, as well as the temporal variability of electricity demand. In addition, markets for providing secondary positive and negative control reserve were introduced into the model. Finally, Power-to-X pathways are also included.

##### a) Representation of electricity transmission and distribution grids

The electricity supply sector of STEM now includes now four different grid voltage levels:

1. Grid level 1: 220/380 kV
2. Grid level 3: 36 – 150 kV
3. Grid level 5: 1 – 36 kV
4. Grid level 7: 400 V – 1 kV

The grid levels 2, 4 and 6 are transformation levels. In each grid level a set of power plants can be connected and several electricity storage (and dispatchable loads) options can be deployed as illustrated in Figure 6.4.2.

This representation of the electricity grid accounts for economic and not physical electricity flows among the different voltage levels, by considering transmission and distribution costs (adapted from [6]) and transmission and distribution losses (as they reported in energy balances [7]). The grid levels are assumed to be fully dispatchable and to this end the grid capacity is measured in terms of Net Transfer Capacity (NTC).

Grid line characteristics such as thermal capacity, resistance and reactance, via DC power flow modelling, are introduced in Section 7 (see next chapter).

### b) Temporal variability in electricity supply and demand and storage capacity requirements

The short-term temporal variability of both electricity supply and demand is captured via the concept of the residual load duration curve (RLDC) []. More specifically, the different power plants can be grouped into categories, e.g. dispatchable loads, thermal loads, non-dispatchable loads, run-of-river hydro, wind, solar, etc.. In each typical operating hour, the residual load duration curve  $l^{res}$  is calculated based on the dispatchable generation  $p_i^{disp}$  of each dispatchable unit  $i \in I$ , the charges  $in_s^{stg}$  and discharges  $out_s^{stg}$  of each storage process  $s \in S$  and the possible load curtailment  $l^{cur}$ :

$$l^{res} = \sum_{i \in I} p_i^{disp} + \sum_{s \in S} (out_s^{stg} - in_s^{stg}) - l^{cur} \quad (8)$$

Then, the storage capacity must accommodate exogenously given downward variation  $VAR^{res-}$  of the residual load duration curve  $l^{res}$  and exogenously given upward variation of the non-dispatchable generation  $p_k^{non-disp}$  from the non-dispatchable load category  $k$  (e.g. wind, solar, run-of-river hydro, CHP, etc.):

$$\sum_{s \in S} AF_s^{stg} \cdot CAP_s^{stg} \geq \sum_{i \in I} AF_i^{disp} \cdot CAP_i^{disp} - (1 - VAR^{res-}) \cdot l^{res} + \sum_{k \in K} VAR^{k+} \cdot P_k^{nondisp} \quad (9)$$

Finally, the dispatchable peak load capacity should accommodate exogenously given upward variation  $VAR^{res+}$  of the residual load duration curve  $l^{res}$  and downward variation  $VAR^{k-}$  of non-dispatchable generation:

$$\sum_{s \in S} AF_s^{stg} \cdot CAP_s^{stg} + \sum_{i \in I} AF_i^{disp} \cdot CAP_i^{disp} \geq (1 + VAR^{res+}) \cdot l^{res} + \sum_{k \in K} VAR^{k-} \cdot P_k^{nondisp} \quad (10)$$

Eq. 9 defines the minimum available storage capacity in each typical operating hour, while eq. 10 defines the minimum dispatchable capacity. In fact, eq. 10 is supplementary to the classical reserve margin constraint used widely in energy systems models. In addition, by substituting in eq.9 the term  $\sum_{i \in I} AF_i^{disp} \cdot CAP_i^{disp}$  with  $\sum_{i \in I} MINOP_i^{disp} \cdot CAP_i^{disp}$ , where  $MINOP^{disp}$  is the minimum operating level of a hydrothermal dispatchable unit, then the model can also optimize between the losses due to power curtailment and investments in new storage. More details about the methodology for implementing the residual load duration curves in the STEM model are given in [6].

### c) Secondary positive and negative control reserve and balancing services markets

Variable renewable energy sources, such as wind and solar, are often thought to increase the capacity reserve requirement due to forecast errors in their production that have to be balanced by the power system. Three types of operating reserves can be distinguished, viz. primary, secondary and tertiary [7]. Reserve services may be also provided by demand response measures facilitated through smart grids, as well as batteries. Markets for the trade of reserve provision services (balancing markets) may help to ensure that all options complete against each other to provide reserve at the lowest costs.

The STEM model has been extended to endogenously model the demand for primary<sup>4</sup> and secondary control reserves. This is based on a probabilistic approach, described in [8]. First the individual probability density functions of the random variables regarding the electricity demand and electricity production from wind and solar are estimated, using historical data [9] and theoretical considerations [10]. Then the joint probability distribution is derived by means of statistical co-evolution. Thereby, it is assumed statistical independence among the probability distributions of the co-evolution. Additional random variables, such that plant outages, can also be considered in the formulation provided that their underlying probability density function is available. Positive and negative reserves requirements are set then in a way that the area under the joint probability density function equals three standard deviations [11].

Eq. 11 estimates the demand for the reserve type  $r$  in a typical operating hour  $t$  for year  $y$ , based on the standard deviation of the estimated forecast errors  $\sigma^2$  for wind electricity  $G_{wind}$ , solar electricity  $G_{solar}$  and electricity load  $L_{load}$  and by, optionally, accounting for the potential outage of the largest power plant unit in the system  $K$ .

$$R_{t,y} = 3 \cdot \sqrt{\sigma_{solar,t,y}^2 \cdot G_{solar,t,y}^2 + \sigma_{wind,t,y}^2 \cdot G_{wind,t,y}^2 + \sigma_{load,t,y}^2 \cdot L_{load,t,y}^2} + K_y \quad (11)$$

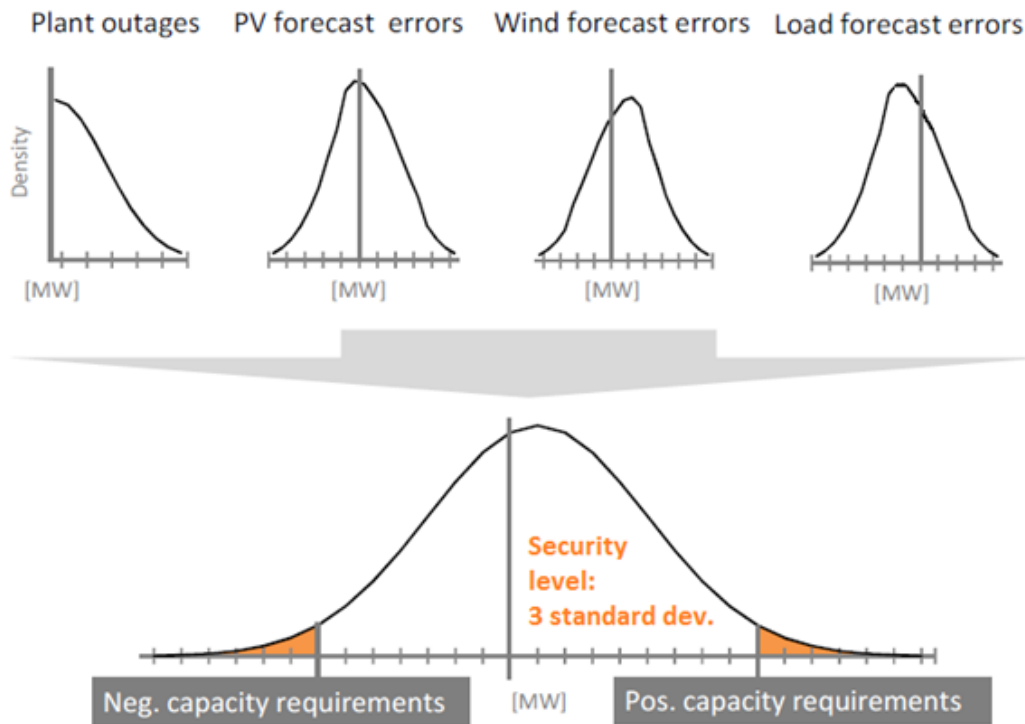

Figure 6.2: Probabilistic approach for ex-ante determination of requiring positive and negative control reserve capacity [8]

The competitiveness of each power plant in participating in both electricity and balancing services markets is determined by its capital and operating costs, as well as its ramping rates and

<sup>4</sup>The primary reserve capacity requirements at any time are adjusted in the reality annually in November in accordance with the ENTSO-E requirements. For Switzerland, this is approximately  $\pm 70$  MW with a frequency deviation of  $\pm 200$  MHz



minimum stable operation levels. Based on the approach followed in [12] a power plant is classified into one of the following three categories with respect to its ability to provide primary and secondary control

- The first category includes flexible units with high ramping rates, which can provide positive reserve up to their total available capacity. In addition there is no constraint for providing negative reserve since these technologies can ramp up and down fast enough. In this case no more capacity is required to be online other than what is needed for electricity generation (see Figure 6.4.2a).
- The second category includes non-flexible units that cannot be ramped down to zero output or back up to their operating level within the reserve timeframe. This means that these units have to operate above their minimum stable operation level and in between their operating range in order to provide reserve. The negative reserve is then limited by the difference between the current electricity generation level and the minimum stable operation, while the positive reserve is constrained by the ramping characteristics of the online capacity. Therefore, the online capacity should be enough to provide power output plus positive reserve services (see Figure 6.4.2b).
- Finally, the third category includes technologies that cannot provide fast enough primary reserve but are suitable for secondary reserve. This implies a combination of the above two categories: the provision of primary reserve requires electricity generation below the online capacity in order to be able to ramp-up if needed, and it is constrained by the ramping characteristics of the online capacity, while the secondary reserve is independent of the online capacity and it is limited by the ramping characteristics of the total available capacity of the technology.

**d) Representation of power – to – hydrogen and power – to – gas pathways** Power-to-hydrogen and power-to-gas pathways are included in the STEM model, as shown in Figure 6.4.2. Electricity is converted to hydrogen, which then can be directly injected into natural gas grid or utilized directly in industrial sector (for heating or CHP fuel cell), or finally converted into synthetic natural gas (methanation) and used in end-use and electricity supply sectors. The maximum quantity of hydrogen that can be injected into the high pressure gas grid is set to 4% by volume (or around 0.6% by mass) [13].

The electrolysis is based on the PEM technology as characterized in Task 2.1 (WP2). Different sizes of electrolyzers are included in the model, depending on the grid level to which they are connected (grid levels 3 or 5). The hydrogen distribution infrastructure considers pipeline distribution in urban areas and truck deliveries in rural areas. In all possible conversion stages it is assumed that hydrogen is in gaseous form.

## 6.5 Results

Figure 6.4.2 presents the evolution of the specific investment cost (in terms of energy) for the different non-pump hydro electricity storage options used in the model. Table 1 presents the costs for electrolyzers and hydrogen methanation technologies both at large and medium scales. The

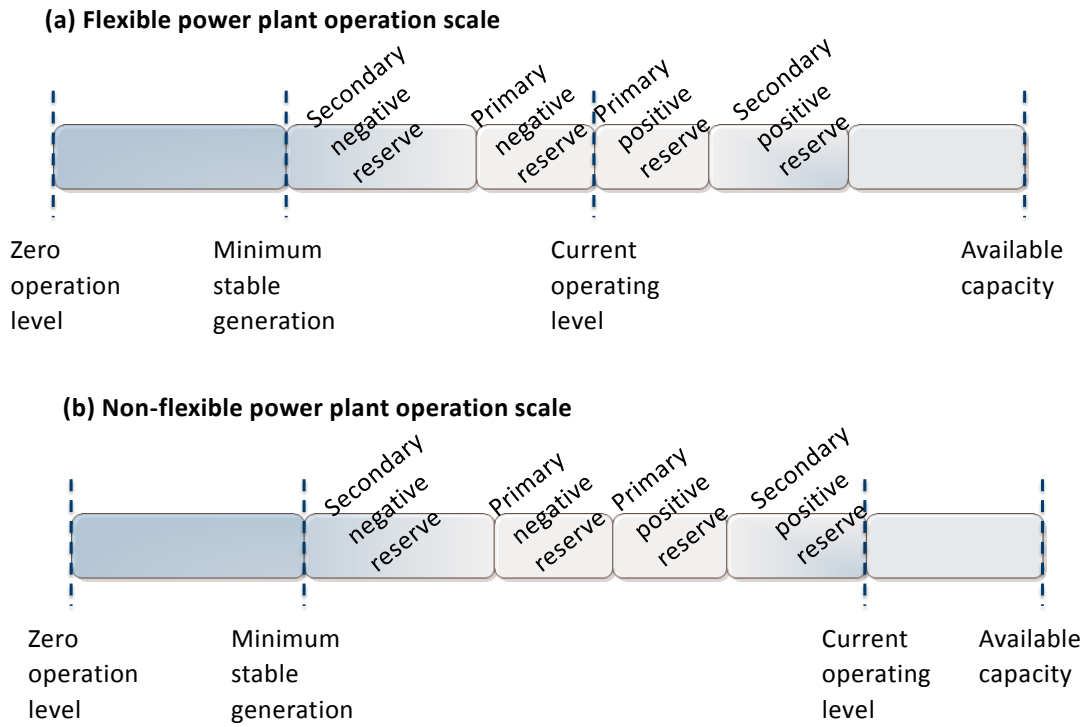

Figure 6.3: Power plant operating scales for a flexible unit (a) and a non-flexible unit (b) with respect to the electricity generation and reserve provision.

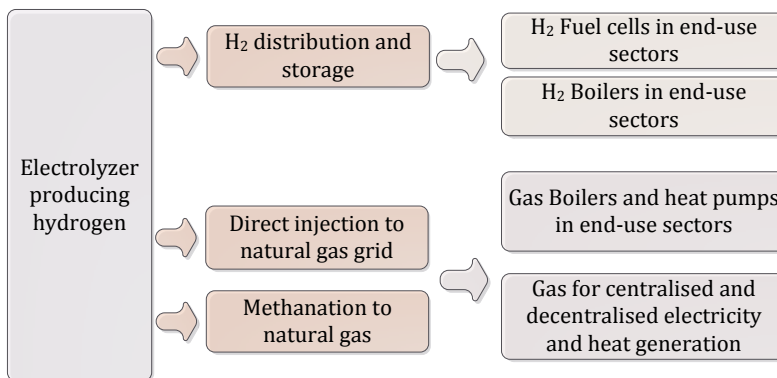

Figure 6.4: Power-to-hydrogen and power-to-gas pathways

long-term specific investment cost reductions are compatible with the cost evolution projected in [4].

Table 6.1: Costs and efficiency of electrolyzers and hydrogen methanation technologies.

	Specific investment cost CHF/kW		O&M cost CHF/kW		Efficiency	
	2020	2050	2020	2050	2020	2050
PEM electrolyzer large scale	2'040	950	40	20	70%	75%
PEM electrolyzer medium scale	3'550	1'650	80	40	70%	75%
Methanation of H2 to CH4 large scale	1'250	800	110	50	74%	85%
Methanation of H2 to CH4 medium scale	1'750	1'000	160	60	74%	85%

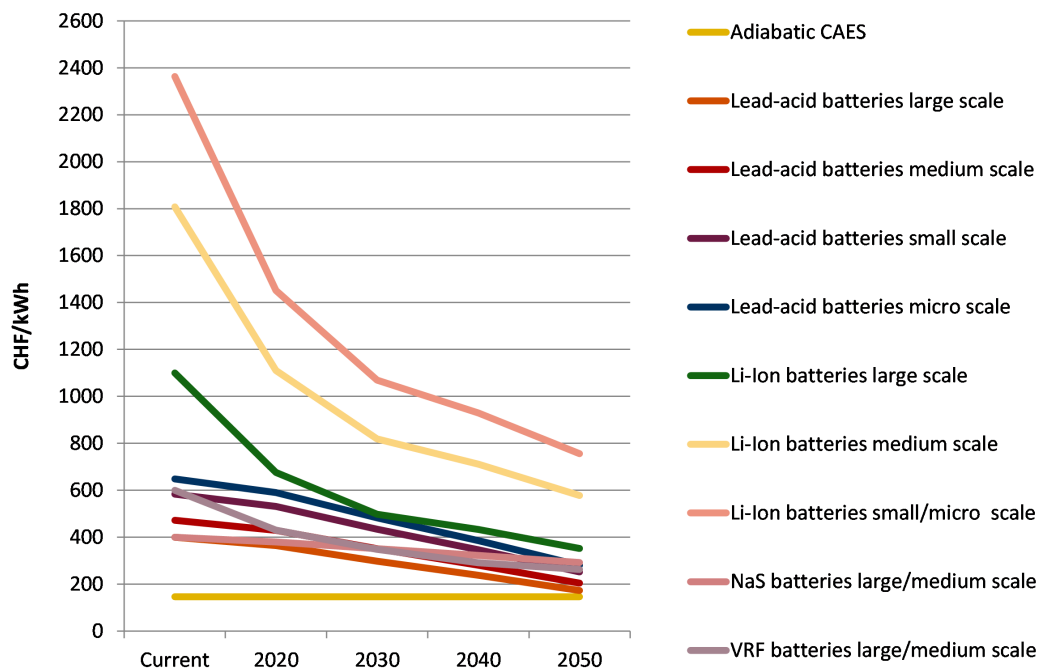

Figure 6.5: Evolution of electricity storage costs, in terms of energy, for different scales (excluding pumped hydro).

## 6.6 Conclusions

The main outcome from Section 6 is an improved version of the electricity module of the STEM model, suitable for assessing renewable energy integration strategies. The new electricity module includes: a) a richer technology database regarding the characterization of the electricity storage option; b) a representation of balancing services markets; c) an enhanced representation of the temporal variability of electricity generation and supply; and d) a representation of different electricity grid levels to which a range of power and storage options can be connected. These enhancements constitute the STEM model a unique in its kind tool in Switzerland, since it can assess the impact of energy and climate change mitigation policies on electricity supply and demand. The foci are not only on the long-term capacity expansion planning but also on short-term electricity market operational decisions.

## 6.7 Future Work

The energy modelling tasks carried in Section 6 set the basis for future work in improving basic assumptions used for modelling the balancing services market and the representation of temporal variation of renewables. For example, the endogenous modelling of secondary control reserve capacity requirements is based on exogenously given forecast errors for wind and solar electricity production, and such information is not directly available. Another example is the modelling of the residual load duration curves; capturing the temporal variability of electricity supply and demand also relies on exogenously given upward and downward variations, and also such information is not directly available. In both cases, a potential collaboration with the Swiss TSO could improve the assumptions currently used in the model and also could help in enhancing their modelling.

## References

- [1] R. Kannan and H. Turton. *Switzerland energy transition scenarios - development and application of the Swiss TIMES Energy system Model (STEM)*. Report. 2014.
- [2] P. Vögelin et al. *System modelling for assessing the potential of decentralised biomass-CHP plants to stabilise the Swiss electricity network with increased fluctuating renewable generation (CHP SWARM)*. Report. Bundesamt für Energie (BFE), 2016.
- [3] E. Panos and R. Kannan. “The role of domestic biomass in electricity, heat and grid balancing markets in Switzerland”. In: *Energy* 112 (2016), pp. 1120–1138.
- [4] C. Hewicker et al. *Energiespeicher in der schweiz*. Report. Bundesamt für Energie and KEMA Consulting GmbH, 2013.
- [5] Viessmann (Schweiz) AG. “Preisliste 2017 Heizsysteme”. In: (2017).
- [6] A. Lehtila, G. Giannakidis, and K. Tigas. *Residual Load Curves in TIMES*. Report. IEA - Energy Technology Systems Analysis Programme (ETSAP), 2014.
- [7] M. Beck and M. Scherer. *Overview of ancillary services*. Report. Swissgrid Ltd., 2010.
- [8] Lion Hirth and Inka Ziegenhagen. “Balancing power and variable renewables - Three links”. In: *Renewable and Sustainable Energy Reviews* 50 (2015), pp. 1035–1051. ISSN: 1364-0321.
- [9] Swissgrid. *Energy statistics for electricity production and consumption*. Report. Swissgrid Ltd., 2015.
- [10] B-M. Hodge et al. *Wind Power Forecasting Error Distributions - An International Comparison*. Report. National Renewable Energy Laboratory (NREL), 2012.
- [11] R. Doherty and M. O’ Malley. “A new approach to quantify reserve demand in systems with significant installed wind capacity”. In: *Power Systems, IEEE Transactions* 20 (2005), pp. 587–595.
- [12] M. Welsch et al. “Supporting security and adequacy in future energy systems: The need to enhance long-term energy system models to better treat issues related to variability”. In: *International Journal of Energy Research* 39.3 (2015), pp. 377–396.
- [13] Newton J. “Power-to-gas and methanation – pathways to a hydrogen economy”. In: *14th annual APGTF workshop* (2014).

## **7 WP7: Integration of energy system and grid modeling**

### **7.1 Introduction**

In Section 7 a method was developed to integrate electricity grid constraints from WP5 into the electricity module of the Swiss TIMES energy systems model (STEM), for the long term national energy scenario analysis in WP8. The methodology is based on expanding the electricity module of STEM to include a pseudo-spatial representation of Switzerland, by splitting the country into 7 regions each of which represents a grid node. Then we introduce a set of electricity grid constraints, based on the grid model of WP5, reflecting the power distribution matrix of a reduced version of the detailed underlying Swiss electricity grid (used in WP5). The grid reduction algorithm is described in WP5. The outcome from Section 7 is an enhanced electricity module for STEM, with notions of electricity grid security constraints, suitable for the scenario analysis in WP8.

### **7.2 Objectives**

The objective of Section 7 is to have an enhanced STEM model for scenario analysis by incorporating electricity grid operating conditions and constraints, consistent with the detailed electricity network model of WP5. In this sense, this WP facilitates the tasks of Section 8.

### **7.3 Scope**

Section 7 comprises of two sub-tasks. Task 7.1 aims at exploring various integration options of electricity grid into an energy systems model and evaluating them across a number of criteria: soft-links vs hard-links between the STEM model and the detailed power flow model of WP5; required inputs/outputs between the two models and their mapping; level of spatial resolution; temporal granularity, etc.. Then the most suitable method is selected and implemented in Task 7.2.

The task 7.2 deals with the definition of the interface for the approach selected in Task 7.1. The interface is evaluated across a number of criteria such as: computational complexity, data availability, required accuracy and level of detail beyond which accuracy is not improved anymore. A prototype, re-designed several times with respect to the chosen criteria, was firstly designed before embarking on a larger-scale implementation of the approach.

### **7.4 Methodology**

#### **7.4.1 Pseudo-spatial resolution of the electricity sector in the STEM model**

To integrate electricity grid characteristics in STEM, a spatial representation became necessary. To this end, two options were evaluated:

a) Design and development of a new version of the STEM model, in which the Swiss energy system, currently represented as a single-region in the model, would be disaggregated into the individual energy systems of the 7 regions. This approach would facilitate to capture spatial variation of energy system in detail, but it requires extensive data collection, model restructuring,

model recalibration and model testing.

b) Keep the current structure of the STEM model, i.e. as single region national Swiss model (that calculates the electricity supply and consumption at a national scale), and implement the electricity transmission grid security constraints (and the notion of spatial grid nodes) as an add-on. This option minimizes redesign and recalibration of STEM, but spatial variability in energy supply and demands are not endogenously captured.

Since the development of a multi-regional STEM (i.e. the first option) is beyond the scope of the ISCHES project, the second option was selected. Thus, a pseudo-spatial representation of Switzerland | only for the electricity sector is implemented in STEM. This approach is based on exogenously defined shares of each region/grid node in total (national) electricity supply and demand, as the latter is calculated by STEM. Because this is not a true regional representation of Switzerland in the model, we call it “pseudo-spatial”. A similar concept has been applied also in [1]. However, it should be noted that the definition of the exogenous shares largely affect the model results, and this is the main limitation of this approach. Further investigation is required (see also “Future work” section) in order to define these shares with the greatest accuracy possible and enhance the analytical framework of STEM.

#### a) Identification of the pseudo-spatial disaggregation for STEM model

Switzerland was split into 7 sub regions, shown in Fig. 7.4.1. This process was based in a number of criteria: a) available resources (e.g. hydro, biomass, solar, wind, gas pipelines); b) electricity transmission grid congestion issues; c) structure of the electricity consumption, i.e. shares of industry, commercial, residential and transport sectors in the total electricity consumption of the region; and d) plausibility of large electricity generation options, such as gas turbines combined cycle and geothermal.

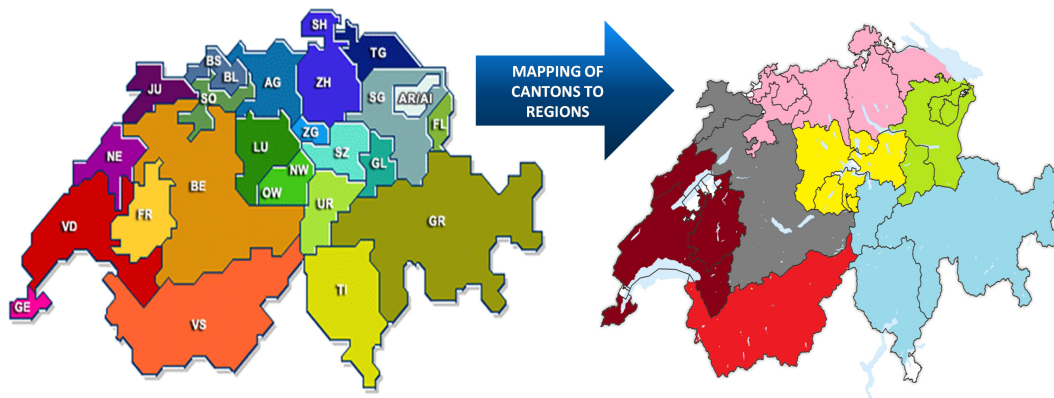

Figure 7.1: Mapping between the Swiss cantons to the regions identified in the STEM model.

Fig. 7.4.1 presents the location of existing power plants in Switzerland (on the left) and the congested electricity grid transmission lines (on the right). The regions were defined based on today’s portfolio of power plants and also to capture the north-south axis grid congestion.

For the selected seven regions, Tab. 7.1 presents the electricity consumption by sector (colors shades in the table correspond to the region colors in Fig. 7.4.1) and their relative share in total national electricity consumption. The shares are derived based on cantonal energy consumption data [4], which is also the basis for allocating the future electricity consumption in the 7 re-

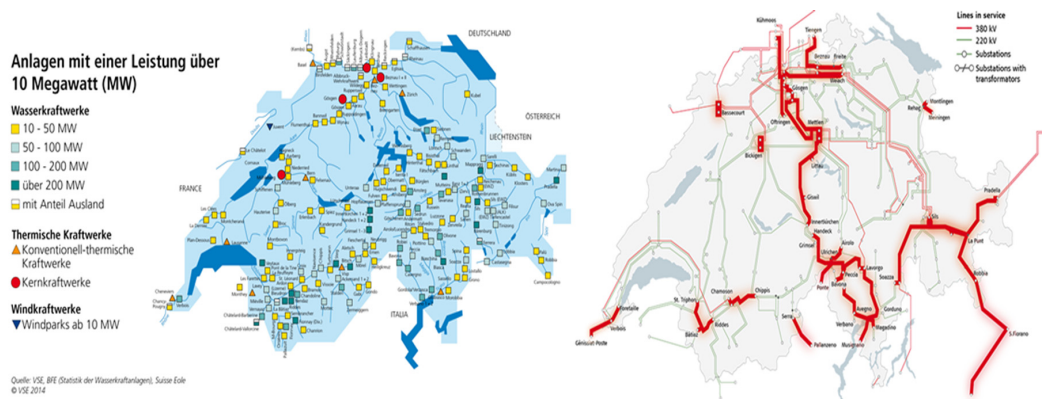

Figure 7.2: Location of existing power plants (left) and congested transmission grid lines (right) in 2014 (source: VSE [2] and Swissgrid [3])

regions (see next subsection). Region 5 (mainly Zurich, Aargau and Basel) is the highly populated region with the largest economic activity, and therefore it dominates in the electricity consumption. On the contrast the regions 2 (representing a single canton, Wallis), 4 (a small region including mainly Lucerne and Zug), 6 (also a small region including mainly Glarus, Solothurn) and 7 (the most sparse populated region including Ticino and Graubünden) are those with the least electricity consumption.

	Residential	Industry	Commercial	Transport	Total	% share
Region 1	2975	3018	3952	526	10471	18%
Region 2	1650	838	670	92	3250	6%
Region 3	2740	2333	2408	446	7927	13%
Region 4	1586	1714	1692	283	5275	9%
Region 5	5479	7959	7235	1342	22015	37%
Region 6	1238	1909	1145	246	4538	8%
Region 7	2665	1258	1415	158	5496	9%
Total	18333	19029	18517	3093	58972	100%

Table 7.1: Electricity consumption by region and sector in GWh, 2014 (colors shades correspond to the region colors of Fig. 7.4.1)

The allocation of electricity generation by source between the different regions is based on a range of data sources for 2014. An indicative list is given below:

- For nuclear and hydro electricity generation, the current power plant locations reported in [5, 6, 7, 8]
- For wind electricity generation, the current wind parks reported in [9]
- For solar electricity generation, the location of the beneficiaries of the feed-in remuneration tariff, together with the installation size and production from rooftop solar PV, reported in [10]
- For CHP power plants, the cantonal allocation reported in [11]

Fig. 7.4.1 presents the regional allocation of the Swiss domestic electricity production in 2014. Region 5 dominates the electricity production because of the nuclear power plants, while the re-

gions 2 and 7 offer hydropower. The mismatch between electricity supply and demand among the regions contributes to electricity grid stress (together with the international trade between Germany and Italy that crosses the Swiss grid).

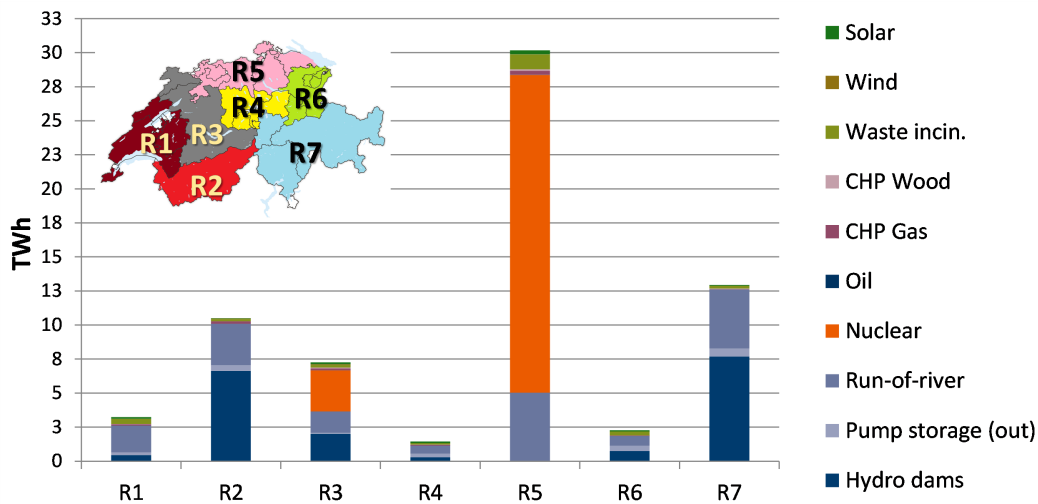

Figure 7.3: Domestic electricity production per region in TWh in 2014

#### b) Definition of allocation shares of the national electricity supply and consumption to the different regions

The shares in each region in both national electricity supply and consumption have to be exogenously given for every modelling year. Till 2020 the shares are based on the allocation of demand and supply according to statistics, as described in the previous subsection. For the electricity supply until 2020, we also account for planned investments that are in advanced stage and are expected to be completed by then. For the electricity demand until 2020, we account for near-term economic developments [12]. For the periods beyond 2020, the regional allocation of electricity supply and demand is described in the following two subsections.

##### Calculation of the regional shares in electricity supply by resource and in electricity

The exogenously defined regional shares for allocating the future national electricity supply calculated by STEM to the 7 Swiss regions, are based on the regional sustainable resource potentials, which were adopted from the cantonal energy strategy reports [13, 14, 15, 16, 17, 18, 19, 20, 21, 22, 23, 24, 25, 26, 27, 28, 29, 30, 31, 32, 33], as well as from additional literature sources specific to each energy carrier (e.g. hydro [34], wind [35, 36, 37, 38], solar [39], biomass [40]). The basic assumption for the long-term shares calculation is that by 2050 the share of each region in the electricity supply by source will follow the share of this region in the total national electricity generation potential from this specific source. For example, according to [39] the share of rooftop solar PV in region 5 in total Swiss national potential is 29%, thus it is assumed that by 2050 region 5 will contribute by 29% in the total Swiss national electricity production from solar PV estimated by the STEM model. More specifically, the following are the assumptions on regional shares for electricity supply by source:

- For nuclear, the existing locations are assumed.



- For hydropower, the new potential reported in [34] is added to the current regional hydropower electricity generation to calculate the future regional shares of hydropower production.
- For wind and solar electricity production, the calculation of the future share of each region is based on its share in total wind and solar electricity potential respectively.
- For CHP electricity and heat production, the long-term share of each region is based on its 2014 electricity and heat consumption, as well as in future development of the building stock [41] as assumed in the Swiss energy strategy [42] and in the new ARE Swiss transport scenarios [43].
- For geothermal electricity the share of each region is based on its long-term potential reported in the energy strategy reports of each Swiss canton, and on the analysis of the deep geothermal energy prospects in Switzerland in [44].
- Finally for large scale gas based electricity generation (gas turbine combined cycle, or gas turbine open cycle) the locations identified in [45] were assumed. In total five locations are candidates for building large scale gas based power plants, viz. Chavalon (VS), Corneux (NE), Perlen (LU), Utzenstorf (BE) and Schweizerhalle (BL).

#### Calculation of the regional shares in electricity consumption by sector

The exogenously given shares for electricity consumption by region and sector in the long term have as a starting point the cantonal electricity consumption in 2014 [4]. Then the long-term share of each region in total national electricity consumption calculated by STEM is calculated by adjusting the today's share with respect to:

- a The electricity consumption by sector projected in the Swiss energy strategy scenarios "Politische Massnahmen" and "Weiter wie bisher" [42], which constitute the two scenarios of electricity and heat demand in WP8.
- b The weight of each sector in region's total electricity consumption as it stands in 2014 [4]; this differentiates the trends in total future electricity consumption among regions.

#### 7.4.2 Integration of electricity grid into the STEM model

Each Swiss region identified in this WP is represented as a single grid node. A set of linear equations allocate electricity generation and consumption into the grid nodes (regions). The general formulation of the equation allocating electricity generation to the grid nodes, defined for each grid node  $i$  and each typical operating hour  $s$  in year  $t$  is as follows (simplified formulation):

$$G_{i,s,t} = \sum_{p \in PE} sh_{i,p,t} \cdot \left( \frac{1}{capact_p \cdot yrfs_s} \cdot (PROD_{p,s,t} + SOUT_{p,s,t} \times (p \in stg)) \right) \quad (12)$$

$G_{i,s,t}$  is the electricity generation in node  $i$ ,  $PE$  is the set of electricity generation units,  $stg \subseteq PE$  is the set of electricity storage options,  $capact_p$  is the conversion coefficient from capacity to production units,  $PROD_{p,s,t}$  is the electricity production from unit  $p$ ,  $SOUT_p$  is the output from a storage process (discharging) and  $yrfs_s$  is the duration of the typical operating hour.

In a similar way, the linear allocation equation of the electricity consumption in a node  $i$  is given by (simplified formulation):

$$L_{i,s,t} = \sum_{c \in CE} sh_{i,c,t} \cdot \left( \frac{1}{capact_c \cdot yrf_c} \cdot (CONS_{c,s,t} + SIN_{c,s,t} \times (c \in stg)) \right) \quad (13)$$

$L_{i,s,t}$  is the electricity consumption in node  $i$ ,  $CE$  is the set of electricity consumption units. It should be noted that cross-border electricity imports and exports are considered to be electricity generation and consumption units respectively.

The introduction of grid characteristics into the STEM model is based on DC Power Flow equations. The general form of the DC flow equations for each node  $i \in N$  with active injected power  $G_i$ , active withdrawn power  $L_i$  and branch flow from node  $i$  to node  $j$   $P_{i,j}$  is:

$$G_i - L_i = \sum_{j \in N} P_{i,j} \quad (14)$$

$$P_{i,j} = B_{i,j} \cdot (\delta_i - \delta_j) = (\delta_i - \delta_j) / X_{i,j} \quad (15)$$

$B_{i,j}$  is the susceptance of the branch connecting nodes  $i$  and  $j$ ,  $X_{i,j}$  is the reactance of the branch connecting nodes  $i$  and  $j$  and  $\delta_i$  is the voltage phase angle of node  $i$  with respect to a reference angle (slack node). To account for simplified N-1 security constraints the branch flow between two nodes can be limited by the maximum line capacity de-rated by a scaling factor  $a$ .

$$|P_{i,j}| \leq (1 - \alpha) \cdot P_{i,j}^{MAX} \quad (16)$$

The equations 14 – 16 define a typical DC load flow problem, which is a linear approximation of an AC load flow formulation.

The network reduction algorithm developed in WP5 replaces (Eq:15) with the an  $E \times N$  matrix  $H$ , where  $E$  is a pre-defined number of grid transmission lines to which the detailed electricity transmission network is reduced and  $N$  is the number of regions. The coefficients in the matrix correspond to the power flow distribution factors among the lines  $E$  and regions  $N$ . In addition, the algorithm replaces (Eq:16) by providing an  $E \times 1$  vector  $b$ , with the line maximum capacities. Thus, the electricity transmission grid security constraints have the following compact formulation:

$$H \times (g - l) \leq b \quad (17)$$

Where,  $g$  is  $N \times 1$  vector of electricity injections in each node calculated according to (Eq:12), and  $l$  is  $N \times 1$  vector of electricity load withdraws calculated by (Eq:13).

Thus, the integration of the electricity grid constraints into the STEM model with pseudo-spatial resolution consists of (Eq:12), (Eq:13) and (Eq:17). These three equations were introduced into the electricity module of the STEM model. The constraints imposed by eq.6 correspond to power flows among the nodes of the underlying detailed Swiss electricity network. A violation of any particular grid constraint in STEM implies a violation of a grid security constraint in the actual Swiss network. Therefore when the STEM model calculates the cost-optimal electricity

generation and consumption levels at the national level, it simultaneously fulfils the power flow constraints within and among the Swiss regions in order not to violate (Eq:17) (see Fig. 7.4.2 for a simplified diagram of the structure of STEM with electricity grid constraints).

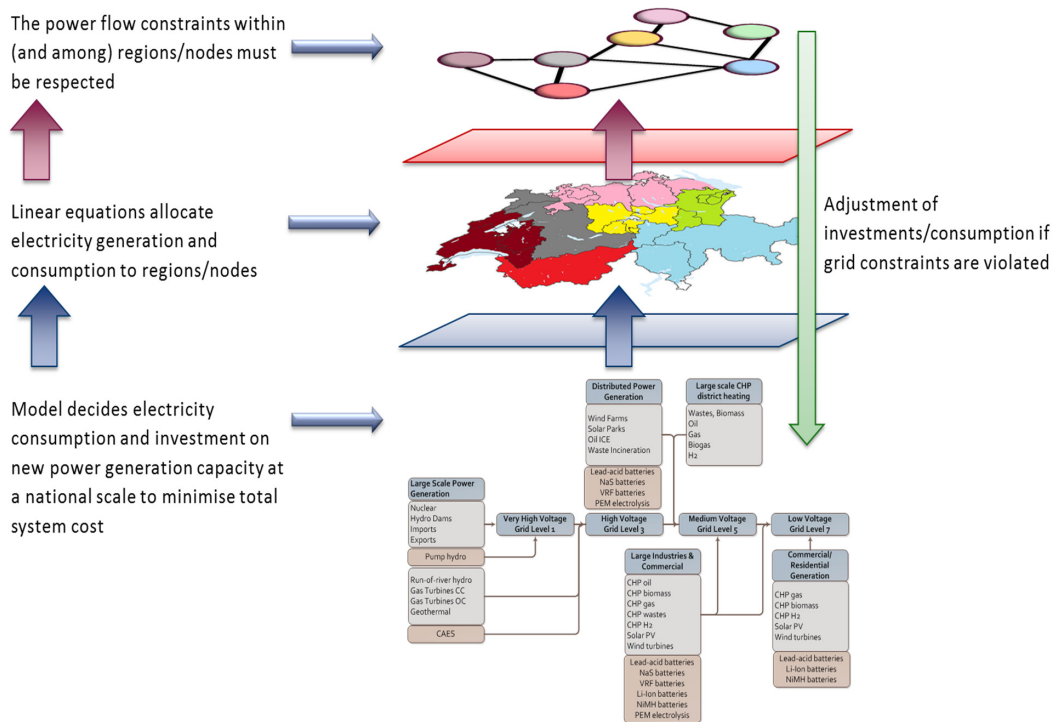

Figure 7.4: A simplified diagram of modelling the electricity grid security constraints as an add-on in the existing structure of STEM; the process is however not iterative

### 7.4.3 Definition of the interface between the energy systems model with grid representation and the detailed electricity grid model

The total number of grid lines  $E$  and nodes  $N$  considered in the interface between the detailed network model and the STEM model was selected based on the trade-off between required accuracy of the reduced network model and overhead in the model size and solution time STEM. A sweet point was selected in the trade-off curve, corresponding to 319 lines (or 638 bi-directional power flows) and 15 grid nodes (7 nodes for each one of the Swiss regions, 4 nodes for each one of the existing nuclear power plants and 4 nodes for each aggregated electricity interconnectors from the four neighboring countries). Thus, 638 instances of eq. 6 were introduced into the STEM model, for each modelling period and typical operating hour. This resulted in doubling the number of equations in the model, and in order to speed up the solution process the following heuristic is applied (Fig. 7.4.3):

1. Run first the model without any grid constraint in place
2. Make an ex-post calculation to identify grid constraints that are violated; if no constraint is violated goto step 5
3. Expand the current set of grid constraints in the model, by introducing in it the newly violated constraints

4. Run again the model and go to step 2
5. Keep the solution and keep the set of grid constraints that are found to be binding into the model structure

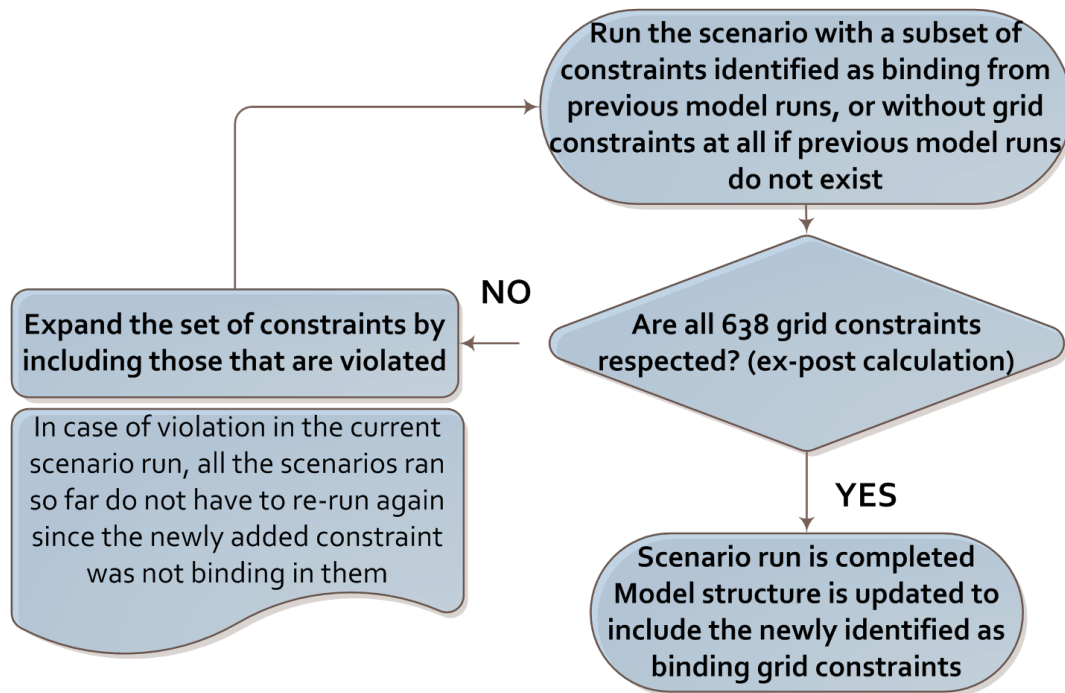

Figure 7.5: Heuristic to speed up the solution time of the STEM model with electricity grid constraints

The enhanced STEM model is soft-coupled with the detailed electricity grid network model for the scenario analysis in WP8.

Fig. 7.4.3 presents a schematic overview of this soft-coupling between the models. A scenario run in Section 8 would consist then of the following steps:

- Initially, the European Swiss TIMES electricity model (EUSTEM) establishes the international boundary conditions on long-term electricity trade between Switzerland and its neighboring countries (marginal costs, volumes and required net transfer capacities).
- The international electricity trade boundary conditions are then entered into the STEM model, together with scenario related energy policy assumptions, and the model outputs the electricity generation portfolio and consumption levels for each one of the 288 typical operating hours in every grid node of the reduced electricity grid network and for every modelling period.
- The electricity generation and consumption profiles are then validated by the detailed electricity grid model of WP5, to assess the dispatchability of the electricity injections and loads with respect to the full scale and detailed grid security constraints.
- If the validation fails and grid security constraint violation occurs in the detailed grid network, then the STEM model re-runs and adjusts its output; the process is repeated until all grid constraints are fulfilled.

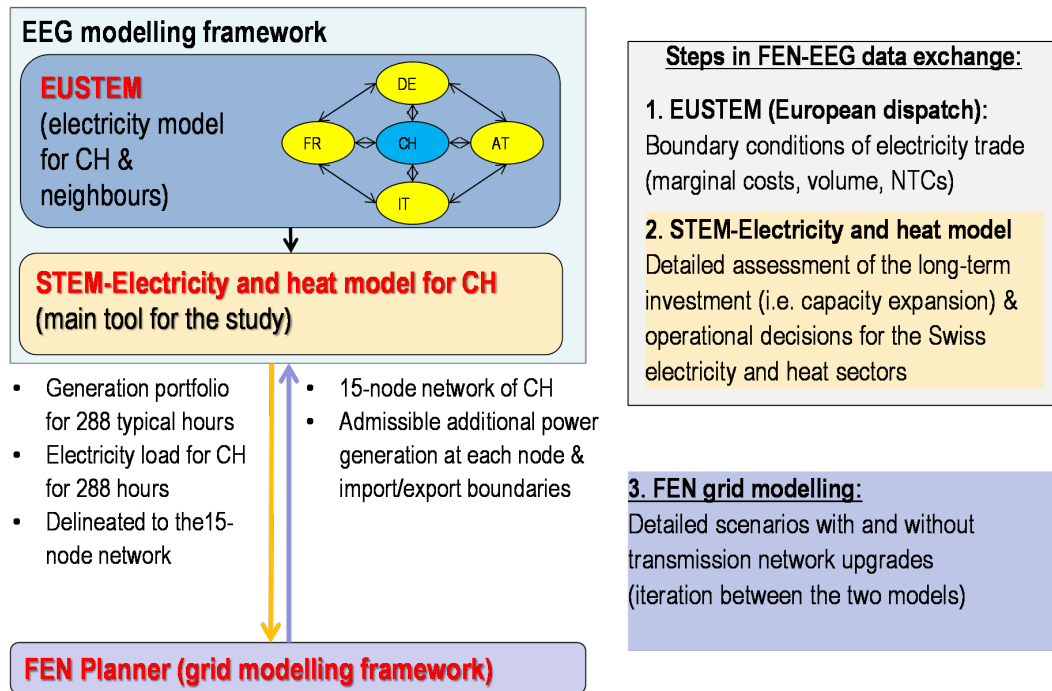

Figure 7.6: Overview of the modelling framework developed in Section 7 and used in the scenario analysis of WP8

## 7.5 Results

In order to demonstrate the value addition from the ad-hoc representation in the STEM model, we present a “Reference” scenario with and without the electricity grid add-on enabled. When the electricity grid add-on is not enabled then also the pseudo-spatial resolution of STEM becomes inactive. The “Reference” scenario assumes a gradual phase out of the existing nuclear power until 2034, and zero net annual imports of electricity from 2020 onwards. This implies that the gap in the electricity supply because of the nuclear phase out has to be covered by domestic sources, for example CHP, large gas power plants and renewables. In addition, the scenario assumes that there will be no additional grid expansion other than the one planned by Swissgrid until 2025 [46] (see Section 8 for the definition of the “Reference” scenario).

In the case that large scale gas generation enters in the future electricity mix to (partially) replace the existing nuclear power plants, it turns out that under the assumption of no further grid expansion the chosen locations and sizes significantly influence the results obtained. As already mentioned, five possible locations have been identified for new large gas power plants: Corneux (NE), Chavalon (VS), Utzenstorf (BE), Perlen (LU) and Schweizerhalle (BL). Based on [47, 48] at least 400 MW of gas turbines are envisaged to be built in each site, although the Swiss energy strategy foresees 5 – 7 large gas power plants (2 – 3.2 GW in total) to replace the existing nuclear power by 2050 [42]. Thus, meaningful sizes for each one of the 5 locations are 0 MW, 400 MW, 800 MW and 1000 MW (=current largest unit in Switzerland). By translating these sizes into shares in total national installed capacity, then the share of each site in total national gas capacity can be 0%, 12.5%, 20% (equal capacity across all sites), 25% and 33.33%.

The above results into 55=3125 possible combinations, but not all of them are meaningful. By

considering only those adding exactly to 100%, then only 26 combinations have to be assessed. These combinations are presented in Tab. 7.2. The numbers presented in the table are the share of each region in total national installed capacity of large gas power plants. For example if the STEM model finds that 3200 MW of gas turbine combined cycle plants have to be installed by 2050, then the Case 1 in the table assumes that 800 MW (25%) are installed in Conreux, 800 MW in Chavalon, 800 MW in Utzenstorf, 400 MW (12.5%) in Perlen and 400 MW in Schweizerhalle.

The results from each one of the 26 cases are then compared with the case in which no electricity grid constraints (and pseudo-spatial resolution) are considered in the model (Case 6). In Case 6, the electricity sector is represented as a copper plate (see also WP6) and only an aggregate grid capacity is considered. To maintain consistency with the no grid expansion assumption in the rest of the 26 cases, in which electricity grid constraints are enabled and the individual line capacities are taken into account, the copper plate aggregated grid capacity considered in Case 6 is also not allowed to expand beyond the expansion levels already announced for 2025.

	Corneux	Chavalon	Utzenstorf	Perlen	Schweizerhalle
Case 1	25.0	25.0	25.0	12.5	12.5
Case 2	33.3	33.3	33.3	0.0	0.0
Case 3	20.0	20.0	20.0	20.0	20.0
Case 4	25.0	12.5	12.5	25.0	25.0
Case 5	12.5	12.5	25.0	25.0	25.0
Case 6	No electricity grid constraints and pseudo-spatial resolution are enabled in Case 6, but the no grid expansion assumption is maintained at an aggregated grid capacity level				
Case 7	0.0	0.0	33.3	33.3	33.3
Case 8	0.0	25.0	25.0	25.0	25.0
Case 9	0.0	33.3	0.0	33.3	33.3
Case 10	0.0	33.3	33.3	0.0	33.3
Case 11	0.0	33.3	33.3	33.3	0.0
Case 12	12.5	25.0	12.5	25.0	25.0
Case 13	12.5	25.0	25.0	12.5	25.0
Case 14	12.5	25.0	25.0	25.0	12.5
Case 15	25.0	0.0	25.0	25.0	25.0
Case 16	25.0	12.5	25.0	12.5	25.0
Case 17	25.0	12.5	25.0	25.0	12.5
Case 18	25.0	25.0	0.0	25.0	25.0
Case 19	25.0	25.0	12.5	12.5	25.0
Case 20	25.0	25.0	12.5	25.0	12.5
Case 21	25.0	25.0	25.0	0.0	25.0
Case 22	25.0	25.0	25.0	25.0	0.0
Case 23	33.3	0.0	0.0	33.3	33.3
Case 24	33.3	0.0	33.3	0.0	33.3
Case 25	33.3	0.0	33.3	33.3	0.0
Case 26	33.3	33.3	0.0	0.0	33.3
Case 27	33.3	33.3	0.0	33.3	0.0

Table 7.2: Contribution of each location in total (national) installed capacity of large scale gas plants (CC), %

Fig. 7.5 summarizes the electricity generation mix for all the different 27 cases regarding the potential size and the location of gas power plants, ordered from the case with the lowest value in the objective function (Case 6, in which no electricity grid constraints are considered) to the case with the highest value in the objective function (Case 11). The figure presents the electricity output per major technology, international imports and exports, and the charged and discharged energy to/from electricity storage options (pump hydro, batteries and Compressed Air Energy Storage).

When the electricity grid constraints are not applied (Case 6), then the cost-optimal solution is about 13.5 TWh of large gas power plants and 9.4 TWh of solar PV. This would have been the solution of the STEM model, without the electricity grid add-on developed in WP7.

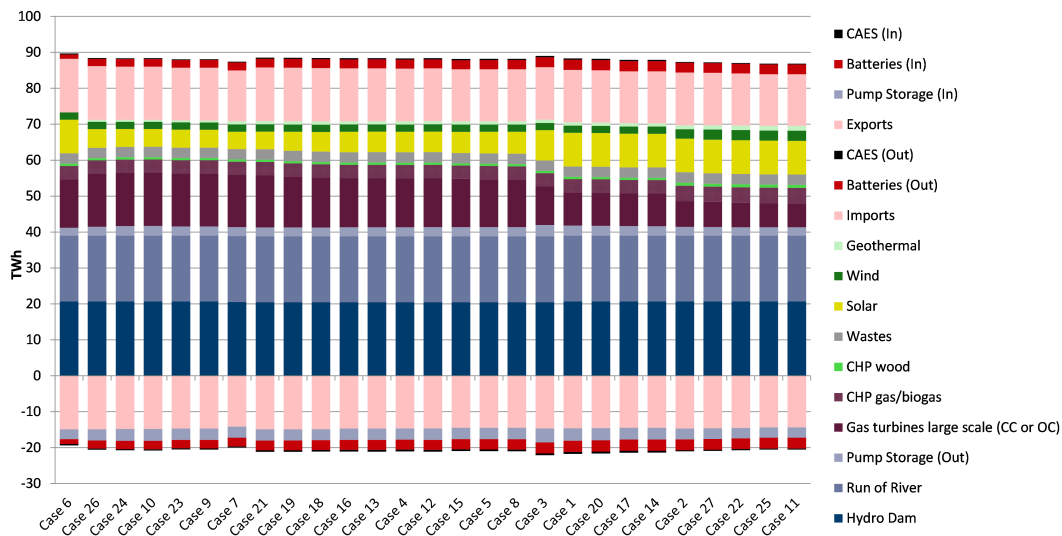

Figure 7.7: Electricity generation mix in 2050, without grid constraints (Case 6) and with grid constraints for different assumptions regarding the locations of large scale gas-based power plants (Cases 1 – 26); the cases are ordered based on the value of the objective function obtained, from the lowest to the highest.

When the electricity grid constraints are enabled in STEM then one or more of the following trends are observed compared to the Case 6:

- Electricity consumption declines because of cost of electricity supply induced by grid congestion.
- There is higher uptake of electricity storage options, mainly batteries, induced by grid congestion which leads to high hourly variability in electricity supply costs (and hence facilitates arbitrage trade) and to more load shifts to relief congestion (and hence more intra-day storage).
- There is less international trade between Switzerland and the neighboring countries because of grid congestion at the Swiss domestic lines.
- There is a trade-off between electricity from large gas power plants and electricity from solar PV, which depends on the location where the gas power plants are installed and the size of each plant in each location. When 33.33% of the total installed gas capacity is located

at Region 5 (Schweizerhalle) then the contribution of gas power plants reaches about 14.8 TWh, while solar PV electricity is limited to about 5.0 - 5.2 TWh (cases 26, 24, 10, 23 and 9). On the other hand, when there is no large gas power plant in Region 5, then the contribution of gas power plants reduces to the lowest levels of 6.7 – 7.2 TWh whereas solar PV generation increases to 9.4 TWh (cases 2, 27, 22, 25 and 11). Finally, when the electricity from large gas power plants is in the vicinity of 13.5 TWh (as in Case 6), then the solar PV electricity is around 5.7 – 5.9 TWh (cases 16, 13, 4, 12 and 15). These imply that the solution obtained with the model version without the electricity grid constraint, which suggests 13.5 TWh of electricity from large gas plants and 9.4 TWh of electricity from solar PV could be technically flawed.

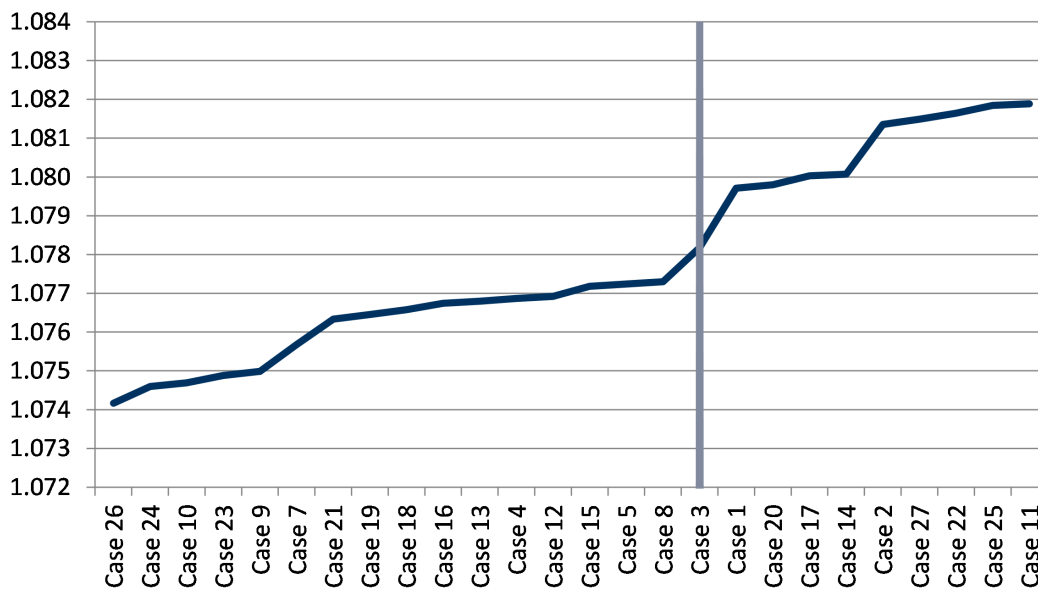

Figure 7.8: Objective function (total discounted system cost) for the 26 cases with grid constraints enabled, in which different assumptions regarding the location and the size of large gas power plants are considered; the values are indexed to the objective function of the case without the grid constraints; the vertical line denotes the Case 3, in which it is assumed that the same capacity of gas plants is installed in each one of the 5 sites.

Fig. 7.5 presents the value of the objective function in the 26 cases in which electricity grid constraints are enabled (from smallest to largest), indexed to the objective function of Case 6 (the case without the electricity grid constraints). The vertical line in the figure corresponds to the value of the objective function in Case 3, in which it is assumed that the same capacity of gas power plants is installed in each one of the 5 locations.

The increase in the objective function also implies increase in the electricity grid stress, which leads in adopting more expensive pathways for electricity supply in some regions in order to relief congestion in other regions. In this context, cases 26, 24, 10, 23 and 9, in which more than 1/3 of the installed capacity of the large gas power plants at the national level is located in Region 5, display the less stress for the electricity grid. On the other hand, cases 2, 27, 22, 25 and 11, in which no large gas power plant is installed in Region 5, create the highest stress for the grid.

Fig. 7.5 presents the long run marginal cost of electricity supply in 2050 for four cases (namely



Case 6, which does not include the electricity grid add-on; Case 26, which has the least stress for the electricity grid; Case 11, which has the highest stress for the electricity grid; and Case 3, which assumes equal allocation of large gas power plants across all five locations). In Case 6, the marginal cost of electricity is negative for about 200 hours, it is on average (simple arithmetic mean) about 14 Rp./kWh and has a maximum value of about 20 Rp./kWh in 2050. In Case 26, the marginal cost of electricity is negative for about 170 hours, it is on average 18 Rp./kWh but its maximum value can be about 58 Rp./kWh. In Case 3, the marginal cost of electricity is also negative for 170 hours, it is on average 19.5 Rp./kWh with maximum 58 Rp./kWh. Finally, in Case 11 the marginal cost is negative for about 150 hours, with an average value of 30 Rp./kWh and maximum 88 Rp./kWh. These results indicate that there is a significant underestimation of the marginal cost of electricity supply when the electricity grid is considered as a copper plate.

Figure 7.9: Long-run marginal cost of electricity supply duration curve in selected cases (vertical axis is limited to -20 Rp./kWh for clarity in the presentation; the actual minimum is -119 Rp./kWh).

## 7.6 Conclusions

The work performed in Section 7 dealt with the introduction of electricity grid network constraints into the STEM energy systems model. Based on the electricity network reduction algorithm developed in WP5, 638 grid lines and 15 grid nodes were introduced into the STEM. The approach followed was to keep the current STEM structure and implement the grid constraints as an add-on, in order to avoid extensive data collection and model restructuring/recalibration in the case of a fully spatial representation of Switzerland.

The pseudo-spatial representation of Switzerland in the STEM model and the introduction of the add-on with the electricity grid constraints improved the model results. The model better

accounts for regional limitations in resource access, as well as limitations in the power flows inside and among the regions imposed by the electricity grid. The comparison of the results obtained by the two model versions with and without the electricity grid representation justifies the model development undertaken in WP7, but it also highlights the need for being extremely careful when choosing the exogenously defined shares of electricity production technologies per region. The new version of the model is therefore suitable to perform the scenario analysis in Section 8 and to evaluate renewable integration strategies, which can be different or having different intensity among the regions.

## 7.7 Future Work

The presented methodology for integrating electricity grid security constraints in a large scale energy systems model reflects a compromise between required accuracy and overhead in model's size and solution times. Further investigation is needed for defining the exogenous shares for allocating the national electricity generation and consumption to the different grid nodes/regions. For the electricity supply shares, this requires a more accurate estimation of the electricity generation potential by source and region as well as updated studies regarding the long-term energy strategy of the individual cantons. For the electricity consumption shares, macroeconomic and demographic long-term indicators need to be collected in more detail at a cantonal level, in order to capture the long-term trends in the socioeconomic structure of the individual cantons and improve the accuracy of the electricity consumption allocation shares. It is also important to explore in future work the possibility to lift the requirement of exogenously defined shares of electricity supply technologies per region and let the model define the optimal locations, without formulating a Mixed Integer Programming problem.

## References

- [1] A. Lehtila and G. Giannakidis. *TIMES Grid Modeling Features*. Report. IEA - Energy Technology Systems Analysis Programme (ETSAP), 2013.
- [2] J. Kappeler. *Stromproduktion aus erneuerbaren Energien ohne Grosswasserkraft*. Report. Amt für Energie und Verkehr Graubünden, 2011.
- [3] Bettina von Kupsch. *Bericht zum Strategischen Netz 2025*. Report. Swissgrid AG, 2015.
- [4] Eymann Lea, Jürg Rohrer, and Matthias Stucki. *Energieverbrauch der Schweizer Kantone*. Report. Forschungsgruppe Erneuerbare Energie ZHAW Wädenswil, 2014.
- [5] BFE. *Schweizerische Gesamtenergiestatistik*. Report. Bundesamt für Energie, 2015.
- [6] BFE. *Schweizerische Elektrizitätsstatistik*. Report. Bundesamt für Energie, 2015.
- [7] Gérard Thürler. *Statistik der Wasserkraftanlagen der Schweiz*. Report. Bundesamt für Energie BFE, 2016.
- [8] BFE. *Wasserkraftpotenzial der Schweiz - Abschätzung des Ausbaupotenzials der Wasserkraftnutzung im Rahmen der Energiestrategie 2050*. Report. Bundesamt für Energie BFE, 2012.
- [9] BFE. *Wind energy plants in Switzerland*. Tech. rep. Bundesamt für Energie BFE, 2016.

- [10] BFE. *Liste aller KEV-Bezüger im Jahr 2015*. Report. Bundesamt für Energie BFE, 2015.
- [11] Urs Kaufmann and eicher+pauli. *Thermische Stromproduktion inklusive Wärmekraftkopplung (WKK) in der Schweiz*. Report. Bundesamt für Energie BFE, 2016.
- [12] SECO. *Economic forecasts*. Tech. rep. State Secretariat for Economic Affairs, 2016.
- [13] Kanton Aargau. *Strategie Kanton Aargau energie AARGAU*. Report. Departement Bau, Verkehr und Umwelt Kanton Aargau, 2015.
- [14] Kanton Appenzell Innerrhoden. *Strategie Energie AI - Bericht zu den Grundlagen*. Report. Bau- und Umweltdepartement Kanton Appenzell I.Rh., 2013.
- [15] Kanton Appenzell Ausserrhoden. *Energiekonzept 2017 - 2025 (Vernehmlassungsentwurf)*. Report. Appenzell Ausserrhoden Departement Bau und Volkswirtschaft Amt für Umwelt, 2016.
- [16] Kanton Bern. *Kanton Bern, Energiestrategie 2016*. Report. Amt für Umweltkoordination und Energie AUE, 2015.
- [17] Kanton Basel-Landschaft. *Energiestrategie 2012 - Grundlagen*. Report. Bau- und Umweltschutzdirektion Amt für Umweltschutz und Energie, 2012.
- [18] Kanton Freiburg. *Energiestrategie Kanton Freiburg*. Report. Amt für Energie AfE, 2014.
- [19] Basler and Hofmann. *Energierichtplan Kanton Glarus - Grundlagenbericht*. Report. Departement Bau und Umwelt des Kantons Glarus, Abteilung Umweltschutz und Energie, 2012.
- [20] Canton du Jura. *"Perspectives énergétiques de la République et Canton du Jura à l'horizon 2035*. Report. Department de l' environnement et de l' equipment, 2012.
- [21] Canton du Neuchâtel. *Conception directrice de l' energie*. Report. Le Grand Conseil de la République et Canton de Neuchâtel, 2015.
- [22] Kanton Obwalden. *Energiekonzept 2009*. Report. Bau - und Raumentwicklungsdepartement Kanton Obwalden, 2009.
- [23] Kanton Nidwalden. *Kantonaler Richtplan*. Report. Amt für Raumentwicklung Kanton Nidwalden, 2014.
- [24] Kanton St. Gallen. *Richtplan Anpassung 2014 - Erneuerbare Energie (Kleinwasserkraftwerke und Windenergieanlagen)*. Report. Kanton St.Gallen Baudepartement Amt für Umwelt und Energie, 2013.
- [25] econcept. *Grundlagen für die Leitlinien und Massnahmen der kantonalen Energiepolitik 2008 - 2017*. Report. Kanton Schaffhausen, 2008.
- [26] Kanton Solothurn. *Energiekonzept Kanton Solothurn*. Report. Amt für Umwelt (Energiefachstelle des Amtes für Wirtschaft und Arbeit) Kanton Solothurn, 2014.
- [27] econcept. *Grundlagen zur energiepolitischen Strategie des Kantons Schwyz*. Report. Baudepartement Kanton Schwyz, 2011.
- [28] Ernst Basler and Partner. *Grundlagenbericht: Konzept fuer einen Thurgauer Strommix ohne Kernenergie*. Report. Department fuer Inneres und Volkswirtschaft (DIV) Kanton Thurgau, 2013.

- [29] Cantone Ticino. *Piano Energetico Cantonale*. Report. Dipartimento del Territorio (DT) and Dipartimento delle finanze e dell'economia (DFE), 2013.
- [30] Kanton Uri. *Gesamtenergiestrategie Uri*. Report. Regierungsrat des Kantons Uri, 2008.
- [31] Canton du Wallis. *Efficacité et approvisionnement en énergie*. Report. Rapport du Département de l'économie, de l'énergie et du territoire au Conseil d'Etat du Valais, 2013.
- [32] econcept. *Erneuerbare Energien im Kanton Zug: Stand heute und Perspektiven 2030*. Report. Amt für Umweltschutz Kanton Zug, 2011.
- [33] Amt für Abfall Wasser Energie und Luft AWEL Kanton Zürich. *Energieerzeugung im Kanton Zürich*. Report. Baudirektion Kanton Zürich, 2102.
- [34] BFE. *Das Potenzial der erneuerbaren Energien bei der Elektrizitätsproduktion*. Report. Bundesamt für Energie BFE, 2012.
- [35] ARE. *Konzept Windenergie - Basis zur Berücksichtigung der Bundesinteressen bei der Planung von Windenergieanlagen*. Report. Bundesamt für Raumentwicklung ARE, 2015.
- [36] AWEL. *Windpotenzial im Kanton Zürich*. Report. Kanton Zürich Baudirektion Amt für Abfall, Wasser, Energie und Luft, 2014.
- [37] Kanton Freiburg. *Kantonale Richtplan*. Report. Kanton Freiburg, 2010.
- [38] Kanton Luzerne. *Windenergie - Grundlagenbericht*. Report. Kanton Luzern, Umwelt und Energie (uwe), 2007.
- [39] Dan Assouline, Nahid Mohajeri, and Jean-Louis Scartezzini. "Quantifying rooftop photovoltaic solar energy potential: A machine learning approach". In: *Solar Energy* 141 (2017), pp. 278–296. ISSN: 0038-092X.
- [40] E. Panos and R. Kannan. "The role of domestic biomass in electricity, heat and grid balancing markets in Switzerland". In: *Energy* 112 (2016), pp. 1120–1138.
- [41] BFS. *Gebäude- und Wohnungsregister*. Tech. rep. Bundesamt für Statistik BFS, 2016.
- [42] A. G. Prognos. *Die Energieperspektiven für die Schweiz bis 2050 (The energy perspectives for Switzerland until 2050)*. Report. Swiss Federal Office of Energy, 2012.
- [43] Nicole Mathys and Andreas Justen. "Perspektiven des Schweizerischen Personen- und Güterverkehrs bis 2040., Hauptbericht". In: *Bundesamt für Raumentwicklung (ARE)* (2016).
- [44] S. Hirschberg et al. *Energy from the Earth. Deep Geothermal as a resource for the future?* TA Swiss, 2015. ISBN: 9783728136558.
- [45] J. Yan and W. Schenler. *Customized Cost Calculation for Carbon Capture and Storage in Switzerland*. Report. Technology Assessment Group Laboratory for Energy Systems Analysis Paul Scherrer Institut, 2012.
- [46] Bettina von Kupsch. *Bericht zum Strategischen Netz 2025*. Report. Swissgrid AG, 2015.
- [47] Alpiq. *Gas-fired combined cycle power stations*. Tech. rep. Alpiq.
- [48] Axpo. *Axpo verzichtet auf Gas-Kombikraftwerke*. Tech. rep. Axpo, 2012.

## **8 WP8 – Assessment of different future energy scenarios**

### **8.1 Introduction**

The workpackage 8 (WP 8) entails national long-term energy scenarios analysis inline with the WP4. Using the extended STEM model from the WP6 and WP7, a set of scenarios are analyzed to generate insights regarding potential impact of the integration of variable electricity generation in the Swiss electricity (and heat) sector. The scenarios are based on a set of “what-if” type questions to meet the energy and climate change mitigation objectives of the Swiss energy strategy [1].

### **8.2 Objectives**

A key focus of the national energy scenario assessment is on the implications of different electricity supply strategies of the Swiss Energy Strategy [1]. The scenario analyses also consider plausible electricity grid expansion strategy and quantify their implications on electricity and heat system. In this context, impact of future electricity supply configurations on grid- operation, investment and stability is assessed; and potential grid barriers or bottlenecks that may hinder the penetration of certain electricity supply technologies and/or deployment of demand side technologies have been identified.

### **8.3 Scope**

WP8 consists of three sub-tasks. The Task 8.1 defines different electricity supply scenarios, with respect to the assumptions and policies in the Swiss energy strategy scenarios. The Task 8.2 analyzes these scenarios with specific focus on the role of the grid infrastructure as an enabler or barrier to the deployment of new electricity generation technologies. The Task 8.3, additionally considers strong climate change mitigation policy (compatible with the Swiss pledges [2]), as well as the international boundary conditions regarding the electricity prices and trade.

### **8.4 Methodology**

#### **8.4.1 A. Definition of scenarios and key assumptions**

The national scenarios assessed in WP8 are defined across two main axes of the Swiss energy strategy: (i) the gradual phase out of the existing nuclear power plants; and (ii) the Swiss climate change mitigation goals. Two sets (families) of scenarios, P and W, were assessed with respect to the electricity and heat sectors’ developments. The P-family scenarios has exogenously given energy service demands compatible with the policies and measures of the “Politische Massnahmen – POM” scenario of the Swiss energy strategy. On the other hand, the W-family has the energy service demands compatible with the developments in the “Weiter Wie Bisher – WWB” scenario of the Swiss energy strategy. It turns out that due to the additional efficiency measures and policies assumed in the “POM” scenario of the Swiss energy strategy, the P-family of scenarios has a lower demand for electricity and heat compared to the W-family. The energy service demands used in the P-family and W-family of scenarios are presented in [3]. Table 1 gives an overview of

	<i>Base case</i>		<i>Climate change</i>		<i>Imports</i>		<i>Nuclear ext.</i>	
	<b>P</b>	<b>W</b>	<b>P-CO2</b>	<b>W-CO2</b>	<b>P-IMP</b>	<b>W-IMP</b>	<b>P-NUC</b>	<b>W-NUC</b>
POM based energy service demands	✓		ü		ü		ü	
WWB based energy service demands		✓		ü		ü		ü
Nuclear phase out by 2034	✓	ü	ü	ü	ü	ü		
Zero net annual electricity imports	✓	ü	ü	ü			ü	ü
-70% CO2 emission reduction in 2050 from 2010			✓	ü				
Net electricity imports are allowed					✓	ü		
Nuclear phase out by 2044 (10 years extension)							✓	ü

Figure 8.1: Definition of scenarios

the scenarios assessed within the project, with respect to the climate policy, nuclear phase-out and a possibility to have positive annual net import balance.

The scenarios in Table 1 have the following key assumptions:

- In scenarios without explicit CO<sub>2</sub> emissions reduction targets, CO<sub>2</sub> prices for the ETS sectors is assumed as in the Swiss energy strategy (reaching about 60 CHF/t CO<sub>2</sub> by 2050) for the power generation and the industrial sectors; while for the residential and services sectors the CO<sub>2</sub> price linearly increases to 120 CHF/t CO<sub>2</sub> by 2050 from its today levels (84 CHF/t CO<sub>2</sub>)<sup>5</sup>.
- The import prices for oil, oil products and gas are derived from the “4D scenario” of IEA Energy Technology Perspectives 2016 [4].
- A technology specific discount rate of 5.5% for end-use sectors and 2.5% for large scale energy supply sectors is applied, reflecting different levels of access to capital. A social discount rate of 2.5% is applied for discounting the future annual electricity and heat total system costs.
- The existing subsidies on renewable electricity are assumed to be gradually phased out by 2030.
- The existing fuel taxes, other than the CO<sub>2</sub> tax, are assumed to continue at the current levels as reported in [5].
- Large scale gas power plants are available from 2025. However, coal and CO<sub>2</sub> capture and storage options are excluded from electricity generation.

Renewable energy potentials were taken from the latest study of PSI [6]. The main difference between this study and the Swiss energy strategy scenarios lies in the solar PV potential: in the newest PSI study it can reach 19 TWh/yr. compared to the approximately 11 TWh/yr in the Swiss energy strategy scenarios. The techno-economic characterization of electricity supply technologies was also obtained from [6], while the techno-economic characterization of heat supply technologies in the end use sectors is based on [3].

The international electricity trade prices between Switzerland and its neighboring countries are provided from the EUSTEM model [7]. Two scenarios from EUSTEM are used (the electricity

<sup>5</sup>When an explicit CO<sub>2</sub> emissions reduction target is given, then the CO<sub>2</sub> price corresponds to the dual of the CO<sub>2</sub> emission constraint of the optimization.

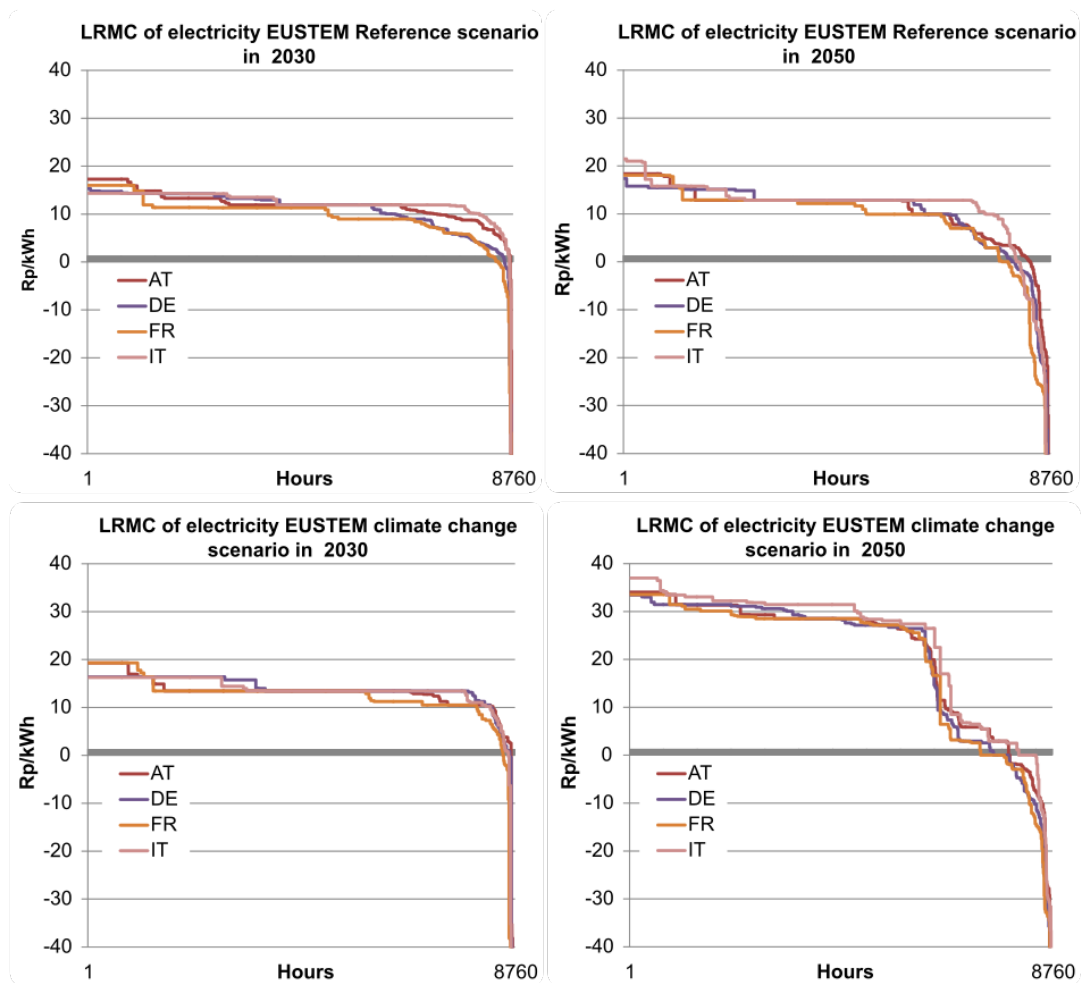

Figure 8.2: Long-run marginal cost of electricity by country of origin from two scenarios: “Reference” is compatible with EU-Trends Reference scenario, while the “Climate Change” scenario assumes 90% CO<sub>2</sub> emission reduction by 2050 from 2010 level in the electricity sector.

marginal costs of which are presented in Figure 8.2). The marginal electricity cost from the “Reference” scenario of the EUSTEM model, which follows the developments of the EU Trends scenario [8], is used as electricity import cost for those core scenarios without strong climate policy. The marginal electricity cost of the “Climate change” scenario of the EUSTEM model, which assumes an almost complete decarbonization of the EU electricity sector by 2050, is used as electricity import cost for those scenarios with climate policy (\*-CO<sub>2</sub> scenarios).

#### 8.4.2 B. Definition of additional scenarios

In addition to the scenarios in Table 1, a set of additional scenario variants (with different energy and climate change policies mixes) are analyzed. These are denoted with a suffix to the scenario family name. For example the scenario “*P-CO<sub>2</sub>-NUC-IMP*” denotes the P-family energy service demands (prefix “P”), with climate policy (“CO<sub>2</sub>”), nuclear operating license extension (“NUC”) and possibility for net imports (suffix “IMP”). For each one of the scenarios, two alternatives were also assessed regarding the level of the grid infrastructure expansion: a restrictive alternative, in which no grid expansion is assumed other than the one already planned for 2025 [9]; and an

<i>No grid expansion</i>		<i>Doubling the most congested grid line</i>	
P	W	P-EXPAND	W-EXPAND
P-CO2	W-CO2	P-CO2-EXPAND	W-CO2-EXPAND
P-IMP	W-IMP	P-IMP-EXPAND	W-IMP-EXPAND
P-NUC	W-NUC	P-NUC-EXPAND	W-NUC-EXPAND
P-NUC-IMP	W-NUC-IMP	P-NUC-IMP-EXPAND	W-NUC-IMP-EXPAND
P-CO2-NUC	W-CO2-NUC	P-CO2-NUC-EXPAND	W-CO2-NUC-EXPAND
P-CO2-IMP	W-CO2-IMP	P-CO2-IMP-EXPAND	W-CO2-IMP-EXPAND
P-CO2-NUC-IMP	W-CO2-NUC-IMP	P-CO2-NUC-IMP-EXPAND	W-CO2-NUC-IMP-EXPAND

Figure 8.3: Complete list of the scenarios assessed, including the electricity grid infrastructure expansion variants

alternative in which the most congested grid line is expanded by doubling its capacity. The identification of the most congested electricity grid line is based on the highest dual value across the underlying grid security constraints implemented in the model (WP7) when no grid expansion is allowed. Table 2 presents the complete list of all assessed scenarios assessed. The suffix *EXPAND* corresponds to electricity grid expansion alternative.

In WP7 it was shown that without grid expansion the location and size of new large gas power plants to be built influence the configuration of the electricity system due to grid congestion. The lowest system cost was obtained when Region 5 builds about one third of the total installed capacity of large gas power plants (or more). In case, when no large gas power plant is installed in Region 5 then the highest electricity and heat system cost occurs. Between these two solutions with the lowest and the highest electricity and heat system cost stands the option of installing the large gas power plants at equal sizes in Regions 1, 2, 3, 4, and 5. Therefore, the scenarios presented in Table 2 were additionally assessed with respect to the potential location and size of new large gas power plants, by considering the following three alternatives:

- The first alternative corresponds to **Case 26 described in WP7** and it assumes that Regions 1, 2, and 5 have one-third of the total installed capacity of large gas power plants at the national level<sup>6</sup>; this alternative results in the lowest system cost across all alternatives assessed in WP7.
- The second alternative corresponds to **Case 3 described in WP7** and it assumes that Regions 1, 2, 3, 4, and 5 have each 1/5 of the total installed capacity of large gas power plants at the national level.
- The third alternative corresponds to **Case 11 described in WP7** and it assumes that Regions 2, 3, and 4 have one-third of the total installed capacity of large gas power plants at the national level; this alternative results in the highest system cost across all alternatives assessed in WP7.

<sup>6</sup>As a reminder from WP7, where the methodological details are given, the installed capacity of power plants is determined endogenously at the national level and then is allocated to the different Swiss regions considered in the model by using exogenously defined shares.



## 8.5 Results

In this section, we present the results for the scenarios “P”, “P-CO2”, “P-IMP”, “W”, “W-CO2”, and “W-IMP”. The results are mainly presented for Case 3, because it presents a good compromise between large-scale and distributed electricity generation and it is neutral regarding the allocation of the gas power plants. In this context, Case 3 is used as a “Reference” case. However, it should be noted that the trends described in Case 3 could be different from the trends in the rest of the two cases. To this end, additional insights from Cases 11 and 26 are explained as appropriate. When the case number is not explicitly mentioned, then the discussion refers to Case 3. Further, both alternatives regarding the grid infrastructure expansion are presented in this section. Key results from all cases are given in the Appendix of this chapter.

### 8.5.1 A. No grid expansion

**Final electricity consumption** In the “P” and “P-IMP” scenarios the final electricity consumption increases by 4.6% in 2050, compared to 2015 levels. This rather small increase in the electricity consumption is attributable to efficiency measures implemented in the “POM” scenario of the Swiss Energy Strategy. In the case that strong climate policy is in place (scenarios “P-CO2” and “P-CO2-IMP”) the final electricity consumption increases by 7.0 – 7.3% in 2050 compared to 2015, driven by high uptake of heat pumps in the heating sectors. In “P-CO2” and “P-CO2-IMP” scenarios heat pumps provide about 26% of heat in industry, 43% in services and 44% in the residential sectors in 2050 (compared to the corresponding cases without climate policy measures, “P” and “P-IMP”, in which the share of heat pumps in industry, services and residential sectors is about 9%, 14% and 23% respectively).

The final electricity consumption in the “W” and “W-IMP” scenarios increases by 14% in 2050 compared to 2015, due to the assumed high energy service demands in these scenarios. Similar to the P-family of scenarios, when strong climate policy is in place the electricity consumption increases by 17% in 2050 compared to 2015 due to increased electrification in heating in the end use sectors (in order to reduce fossil fuel consumption and emissions) through deployment of heat pumps.

The long-term electricity consumption trends are also affected by the choices on location and size of large gas power plants, under restrictions in the grid expansion. The highest consumption occurs in Case 26 because of the lower electricity production cost (see also WP7). Conversely, the lowest consumption levels occur in Case 11 – driven by high grid congestion that increase the electricity supply cost (see also WP7).

**Electricity generation mix** The electricity generation mix<sup>7</sup> for Case 3 is presented in Figure 8.5. In the “P” scenario, the 22 TWh of nuclear production in 2015 is replaced by large gas power plants and non-hydro renewables (solar, wind and geothermal) by 2050. When there is the possibility for net electricity imports, then the imported electricity is cost effective over the solar PV (“P-IMP”

---

<sup>7</sup>The generation mix presents the electricity output from power plants and electricity storage, as well as the net imports; the difference between the final electricity consumption and the generation is attributable to transmission and distribution losses, as well as electricity consumed for charging the electricity storage options.

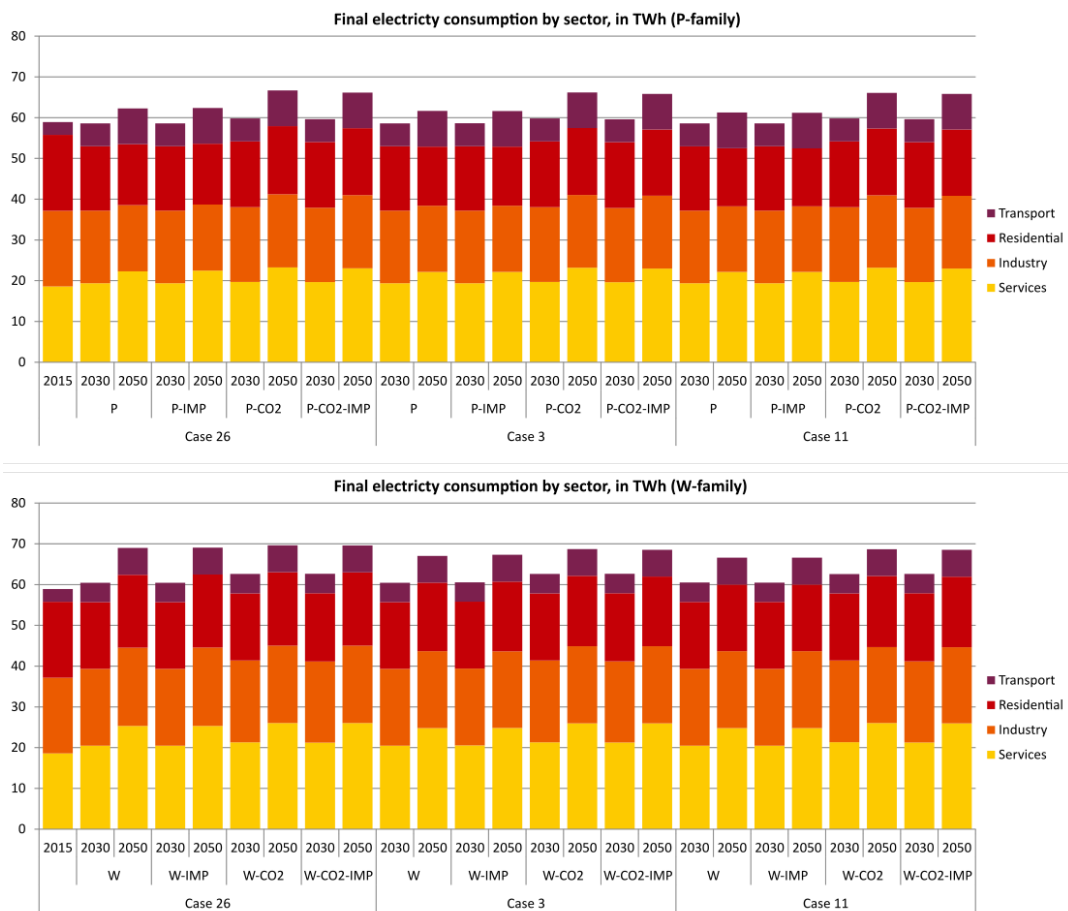

Figure 8.4: Final electricity consumption by end use sector for different assumptions regarding the allocation of large gas power plants in P- and W- family of scenarios

scenario). In both “P” and “P-IMP” scenarios about 1.6 GW of gas turbine combined cycle plants is installed by 2050 (roughly half of the today’s nuclear power plant capacity).

When a strong climate policy is in place (“P-CO2” scenario), solar PV and wind increase their contribution by 11 TWh in 2050 compared to the “P” scenario in the same year. This implies that the large gas power plants of the “P” scenario are replaced (on energy basis) by variable electricity generation by 2050. In addition, geothermal and new hydro dams provide about 4.5 TWh of flexible generation by 2050 compared to 2015 levels). When compared to the “P-CO2” scenario, in the “P-CO2-IMP” scenario 3.5 TWh of net imports occur in 2050, which substitute 2.4 TWh of solar PV electricity and 1.1 TWh of electricity from CHP plants.

In the case of nuclear power plant license extension, the results do not significantly differ in 2050. The main differences are seen in the decade 2030 – 40. The availability of low cost nuclear electricity decelerate investments in gas and renewables and, in the case that the zero net annual net imports restriction is lifted, it results also in annual net exports (see Appendix, Figure 8.27).

In the “W” scenario about 3 GW of gas turbine combined cycle plants are installed already by 2040, completely replacing the existing nuclear power plant capacity. In addition, the new renewables increase their contribution to the electricity supply by 14% (or 1.5 TWh) in 2050, compared to the “P” scenario, in order to satisfy the higher demand. The higher uptake of variable electricity generation and the increased grid congestion caused by the higher electricity supply and demand levels deemed more storage. Electricity output from pump hydro and batteries combined increases by 3.2 TWh in 2050 compared to the “P” scenario.

When annual net imports of electricity are allowed (“W-IMP” scenario), then 4.4 TWh of electricity net exports occur in 2050. This is attributable to congestion relief at specific hours with high non-dispatchable electricity generation. Viewed another way, excess electricity production, which cannot be domestically dispatched, is exported (“dumping”) to the neighboring countries. The contribution of electricity trade in alleviating the grid congestion is more pronounced in the “W-IMP” scenario than in the “P-IMP” scenario. This affects the competitiveness and the deployment of pump hydro and batteries, which reduce their output in the “W-IMP” by 1.5 TWh in 2050. Also, in the “W-IMP” scenario there is increased supply from large gas based generation (3.1 TWh compared to the “W” scenario in 2050), which compensates for the reduced contribution from electricity storage in balancing the electricity supply and demand.

When strong climate policy is in place (“W-CO2” scenario), there is higher penetration of solar, wind and geothermal: these three options increase their electricity output by 14.7 TWh in 2050 compared to the “W” scenario. Under these high shares of variable generation, the balancing of electricity demand and supply is mainly achieved via pump storage and batteries, contribution from which increases by 2050 compared to the “W” scenario. At the same time, geothermal electric plants mainly provide base load electricity, partially substituting the large scale gas power plants in this role.

Similar developments are also observed in the case of strong climate policy combined with the option of annual net imports (“W-CO2-IMP” scenario). However, in contrast to the “W-IMP” scenario where net exports occurred, in the “W-CO2-IMP” scenario the increased final electricity consumption results in net imports of electricity at the expense of solar PV and CHP plants. There is still significant contribution in the electricity supply from pump storage and batteries, similar to

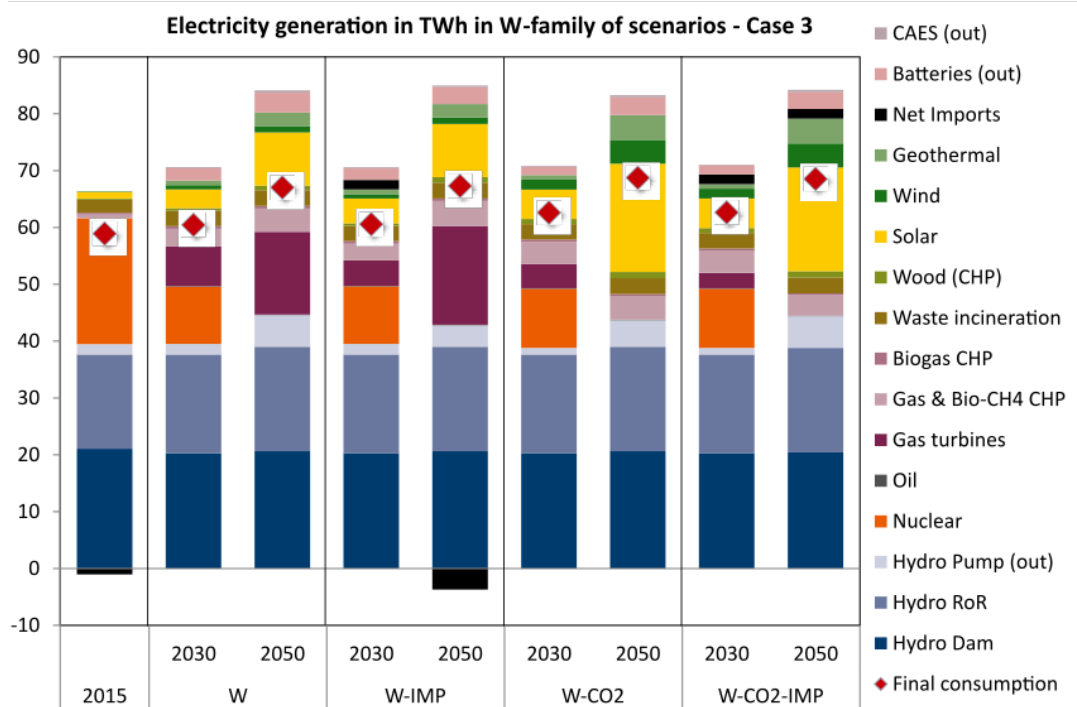
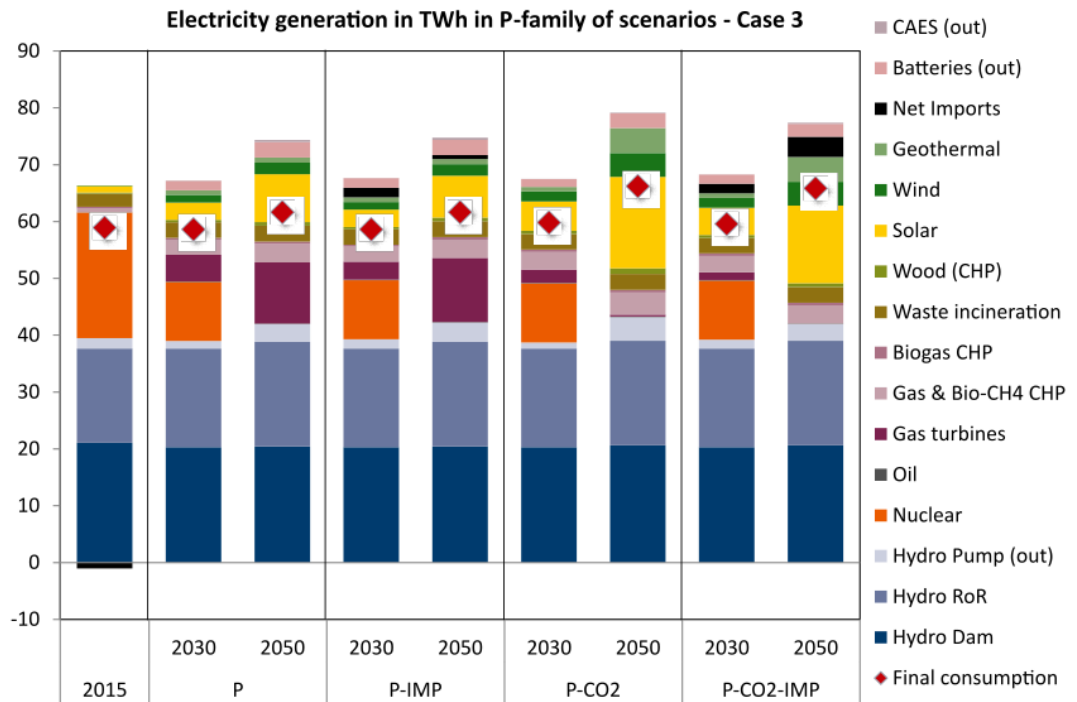

Figure 8.5: Electricity generation by technology and electricity final energy consumption in the P-family (top) and W-family (bottom) when no grid expansion is assumed and for Case 3, in TWh.

the levels seen in the “W-CO2” scenario, which suggests that the balancing of electricity supply and demand is mainly achieved through electricity storage and not by net imports (in contrast to the “W-IMP” scenario where the contribution from pump storage and batteries is reduced compared to the “W” scenario). This implies increased arbitrage from the storage options, and especially pump storage plants (see also Figure 8.10), which use low cost imported electricity for charging in order to supply demand/and or exports at peak hours at high prices.

In all scenarios presented in Figure 8.5, there is an early uptake of geothermal electricity beginning in 2030. This is driven by the grid congestion when there is restriction in the grid expansion, which hampers the dispatchability of large gas power plants. As it is shown in Figure 8.18, when there is grid expansion then the geothermal electricity is not any more cost-effective compared to the large scale gas generation (or imports). In this case, investments in geothermal power plants mainly occur when strong climate change mitigation policy is in place in order to reduce the CO<sub>2</sub> emissions.

**Impact of the choices in location and sizes of large gas power plants on the electricity generation mix** As already mentioned, the assumptions regarding the location of large gas power plants and the size of these power plants influence the investments in new electricity generation technologies, such as solar PV, wind, geothermal and batteries. Figure 8.6 provides additional insights regarding the generation mix of the key electricity technologies that substitute nuclear electricity by 2050, under the different allocation schemes of large gas power plants considered in the three assessed cases, *viz.* Case 26, Case 3 and Case 11, and when restriction in the grid expansion is in place.

The Case 26 (in which Regions 1, 2, and 5 have 1/3 of the total installed capacity of large gas power plants at the national level) has the largest level of gas based electricity supply. The increased uptake of gas turbines in this case is at the expense of solar PV and wind, due to congestion rents that reduce the cost-effectiveness of the variable renewable generation (this is not the case when the grid were to be expanded as shown in Figure 8.18).

Conversely, in Case 11 (in which Regions 2, 3, and 4 have each one of 1/3 of the total installed capacity of large gas power plants at the national level) the contribution from large gas power plants in the electricity supply is at its lowest levels. This is mainly due to the grid congestion occurring in these regions, when there is no grid expansion, because of inadequate grid capacity to dispatch additional to existing hydropower and large scale gas electricity generation. Thus, additional investments in solar, wind and geothermal energy are induced, mainly in regions other than those with large gas power plants, in order to meet the demand. In Case 11, geothermal electricity plants mostly provide base load electricity in order to partially compensate the reduced output from the large scale gas plants. In addition, the increased grid congestion, the higher uptake of variable generation and the high congestion rents creating arbitrage opportunities, enable investments in electricity storage. As a result, pump hydro and batteries attain high levels of penetration into the electricity generation mix in Case 11.

Finally, Case 3 stands in the middle between these two extreme cases regarding the penetration of gas turbines combined cycle in the future electricity generation mix. Case 3 allows for quite high integration of solar and wind electricity at levels close to the Case 11 (which displays

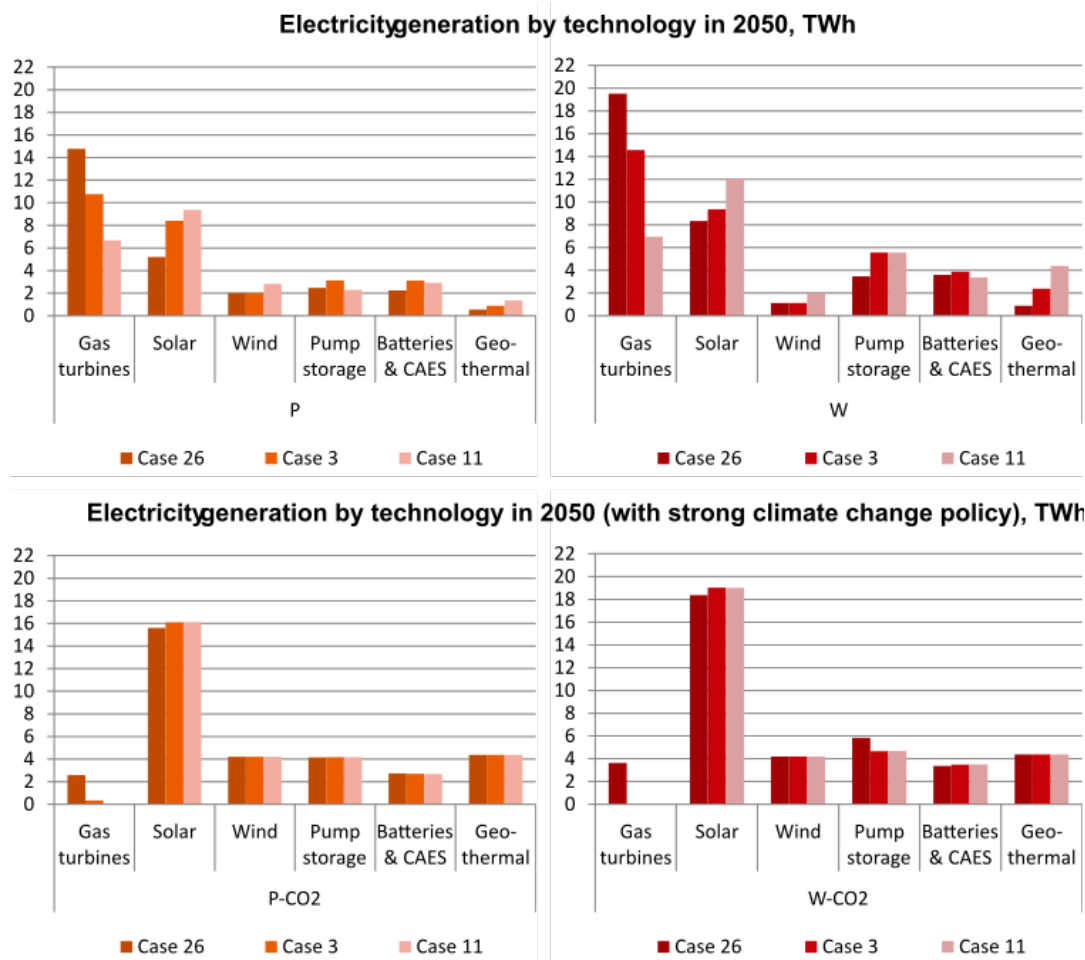

Figure 8.6: Electricity generation by technology in 2050, under different allocation schemes of large gas power plants, in TWh (the results in the corresponding scenarios with imports)

the highest quantities of generation from variable renewable energy sources across all cases assessed in WP7). In this sense, under the assumption of no further grid expansion other than the one planned till 2025, Case 3 constitutes a compromise between large scale and decentralized electricity generation.

**Regional insights in the electricity generation mix** Figure 8.7 presents the electricity generation mix across the 7 Swiss regions of the STEM model in 2050. The figure presents the electricity generation mix for Cases 3, 11 and 26 only for the “P” scenario. This is because similar insights are obtained for the “P-IMP”, “W” and “W-IMP” scenarios too: only the production levels are different in these scenarios compared to the “P” scenario, because of the different levels of electricity final consumption. To provide additional insights on the regional electricity generation mix under strong climate change mitigation policy, the scenario “W-CO2” for case 3 is also shown (since similar trends obtained for the “P-CO2”, “P-CO2-IMP” and “W-CO2-IMP” scenarios); in the case of strong climate change mitigation policy the choice of location and size of large gas power plants does not significantly alter the results, since these plants do not enter into the electricity generation mix and therefore the results are similar across the different allocation cases 3, 11 and 26.

As it is shown in Figure 8.7, Region 5 does not dominate the domestic electricity production

after the nuclear power plant phase out (see also WP7 for the regional electricity production mix in 2015). Instead, the long term regional electricity production looks more uniformly by 2050, compared to 2015. In the “P” scenario the reduction in the electricity production in Region 5 is in the range of 15 – 18 TWh in 2050 compared to 2015 levels. This reduction is compensated with increased generation in the other regions, based on their resource potential.

Looking at the developments in each region separately, in the “P” scenario the electricity supply from Region 1 increases by 4.8 – 8.2 TWh in 2050 from 2015 (which is 3.2 TWh), mainly from gas (+2 – 5 TWh depending on the location of large gas power plants), solar PV (+0.9 – 1.8 TWh) and wind (+0.9 – 1.3 TWh). Region 1 contributes about 11 – 16% to total domestic electricity supply by 2050, compared to 5% in 2015.

The electricity generation in Region 2 increases by 4.7 – 7.2 TWh in 2050, up from 10.5 TWh in 2015; this increase results mainly from gas (+2.2 – 4.9 TWh, depending on the choice/case of locations and sizes), hydro (+1.1 TWh) and solar PV (+0.3 – 0.6 TWh). As a result, Region 2 contributes 20 – 24% to domestic electricity supply in 2050, from 15% in 2015.

Region 3 loses about 3 TWh of regional production due to the nuclear phase out. Its electricity supply increases by 2050 compared to 2015 only when large gas power plants are built; thus, in Cases 3 and 11 the region additionally produces 2.6 – 3.2 TWh in 2050 compared to its production in 2015 (which is 7.3 TWh), mainly from gas power plants (+2.2 TWh), solar PV (+0.7 – 1.4 TWh) and wind (+0.5 – 0.8 TWh). If no gas power plants are built in Region 3, its electricity generation declines by 0.2 TWh in 2050 compared to 2015 (Case 26). Overall, Region 3 has a share of 10 – 14% in domestic electricity supply in 2050, which is relatively close to its share in 2015 (11%).

The electricity generation in Region 4 increases by 1.6 – 4.4 TWh in 2050, from the electricity production in 2015 (1.4 TWh). The additional quantities are mainly produced in gas turbines when these are allowed (+2.2 TWh) and solar PV (+0.6 – 1.1 TWh). Region 4 contributes about 4 – 8% in total electricity supply in 2050, compared to 2% in 2015.

The electricity production in Region 5 declines from 2015 towards 2050, due to the phase out of the existing nuclear power plants. In this context, about 23 TWh of electricity production is lost in the region, which are partially substituted by solar generation (+1.2 – 2.4 TWh), gas (+1 – 1.3 TWh), geothermal (+0.3 – 0.7 TWh) and wind (+0.2 – 0.3 TWh). As a result, the contribution of Region 5 in domestic electricity declines to 17 – 20% in 2050, from 44% in 2015.

In Region 6 the electricity generation increases by 0.8 – 1.2 TWh in 2050 from the level of production in 2015 (2.3 TWh), mainly from solar PV (+0.2 – 0.5 TWh) and hydro (+0.2 TWh). However, Region 6 remains the region with the lowest contribution in domestic electricity supply in the long term, with a share slightly higher in 2050 than in 2015 (5% instead of 3%).

Finally, in Region 7 the electricity generation increases by 3.3 – 3.9 TWh in 2050, compared to the electricity production of 12.9 TWh in 2015. The additional generation mainly comes from further exploitation of hydropower (+1.8 TWh) and deployment of solar PV (+0.4 – 0.8 TWh). In addition, there is an increased level of electricity storage, namely from pumped hydro storage (+0.3 TWh) and CAES (+0.2 – 0.4 TWh) in 2050.

In the “W-CO2” scenario, where strong climate policy and high electricity demand are assumed, the renewable potentials are fully exploited in all regions. To this end, the electricity generation in Region 1 increases by 8 TWh in 2050 compared to 2015, of which 3.7 TWh are from

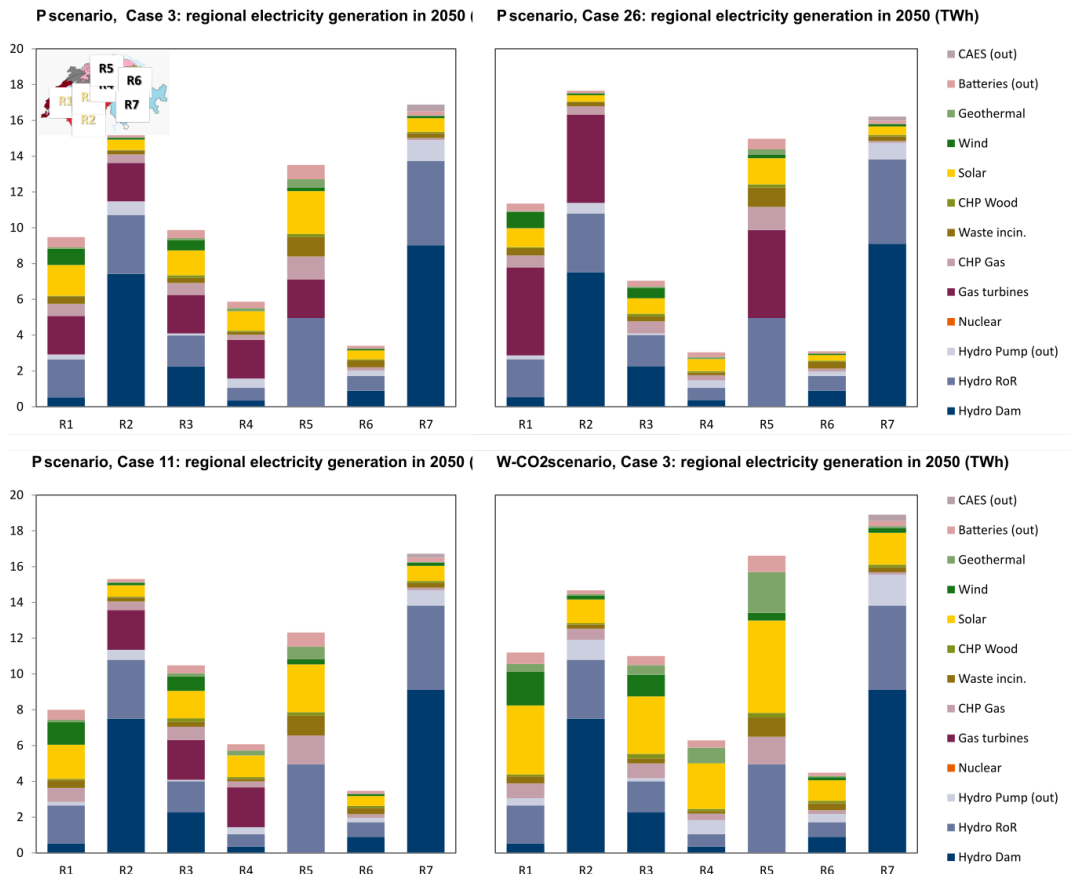

Figure 8.7: Regional electricity generation in 2050 (in TWh), for different regional allocation of large gas power plants (Cases 3, 11 and 26) in the P- scenario family; also the regional electricity mix under strong climate policy and high electricity demand (W\_CO2) is presented for Case 3 (similar results are obtained for the rest of the cases when strong climate policy and high electricity demand are assumed).



solar PV, 1.9 TWh from wind and 0.4 TWh from geothermal.

Similarly in Region 2 the electricity generation increases by 4.2 TWh in 2050, from 2015, of which 1.3 TWh from solar PV, 1.1 TWh from new hydropower, and 0.7 TWh from pump storage. In the same period, in Region 3, the electricity supply increases by 3.7 TWh, of which 3.1 TWh from solar PV, 1.1 TWh from wind and 0.5 TWh from geothermal (while 3 TWh of nuclear power are phased out by 2035). In Region 4 the electricity supply is 4.8 TWh higher in 2050 than in 2015, resulting from an increased penetration of solar PV (2.9 TWh) and geothermal (0.9 TWh).

Region 5, however, is the only region where electricity production in 2050 declines compared to 2015, because of the nuclear power plant phase out. In the same period, supply from solar PV increases by 4.9 TWh, the highest increase across all the regions, attributable to its large rooftop potential. Geothermal electricity contributes with additional 2.3 TWh in 2050. In Region 6, the electricity generation increases by 2.2 TWh in 2050 from 2015, half of which is because of a higher uptake of solar PV. Finally, the electricity generation in Region 7 increases by 6 TWh in 2050 from 2015, of which 1.8 TWh is hydropower, 1.1 TWh is electricity from pump storage, 1.7 TWh is electricity from solar PV, 0.4 TWh is electricity from CAES and 0.3 TWh is electricity from geothermal. By 2050, Region 7 has the highest share in the domestic electricity supply (23%) thanks to its hydropower, followed by Region 5 (20%) with a high share of solar PV electricity and Region 2 (18%) with its hydropower.

**Requirements in electricity storage and its operation profile** The regional distribution of the electricity storage (see also Figure 8.7) depends on the level of solar PV deployment and potential for pump hydro storage and CAES in each region. Thus, regions with high solar PV uptake show high penetration of batteries, while pump hydro storage and CAES are location-specific options available in some regions only. For example, pump hydro storage is not available in Region 5, while Region 7 not only has the highest potential for pump hydro but also hosts the CAES project in Ticino too.

Figure 8.8 presents in detail the need for electricity storage in 2050 for Case 3, in the different core scenarios in 2050. The requirements in electricity storage are higher (in terms of output power - MW) when there is strong climate policy in place that induces increased penetration of variable generation, and when net imports of electricity are restricted. Under these conditions, storage technologies are deployed in response to the high level of grid congestion levels. In this context, the “P-CO2” scenario requires 8.3 GW of electricity storage (including pump hydro capacity) while in the “W-CO2” scenario 8.6 GW of storage are deployed in order to accommodate variations of electricity demand and non-dispatchable electricity by 2050. The availability of net imports provides an additional flexibility for balancing supply and demand and thereby reduces the requirements for electricity storage. However, depending on the cost assumptions for imported electricity, it could be still cost-effective to deploy batteries or pump hydro in order to benefit from the arbitrage trade between hours with high demand and/or excess non-dispatchable electricity generation and hours with low demand and/or high imported prices. This is the case for example in the “W-CO2” and “W-CO2-IMP” scenarios, where the high electricity demand levels increase congestion rents; this results in more opportunities for arbitrage for electricity storage technologies, which mainly occurs in hours when the imported electricity also comes at high costs.

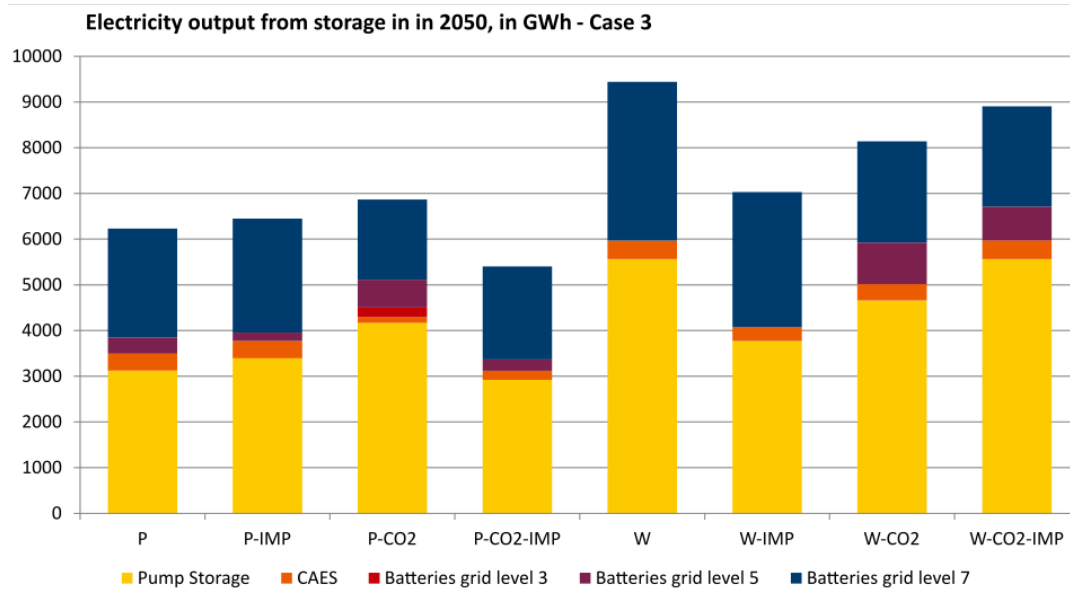
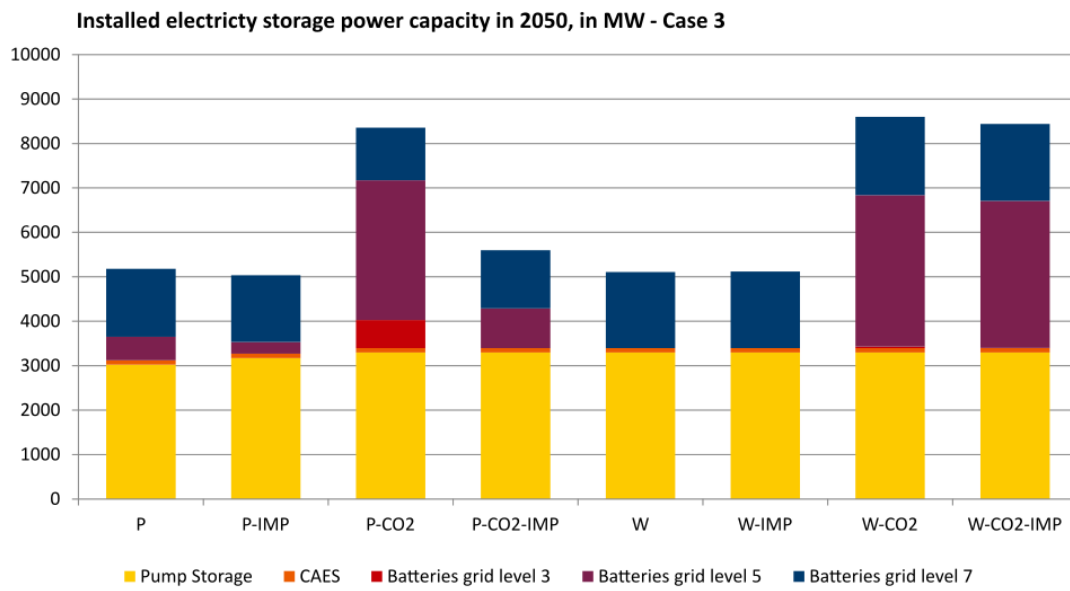

Figure 8.8: Electricity storage installed capacity and generation by type for the P- and W- family of scenarios in Case 3, in GWh.

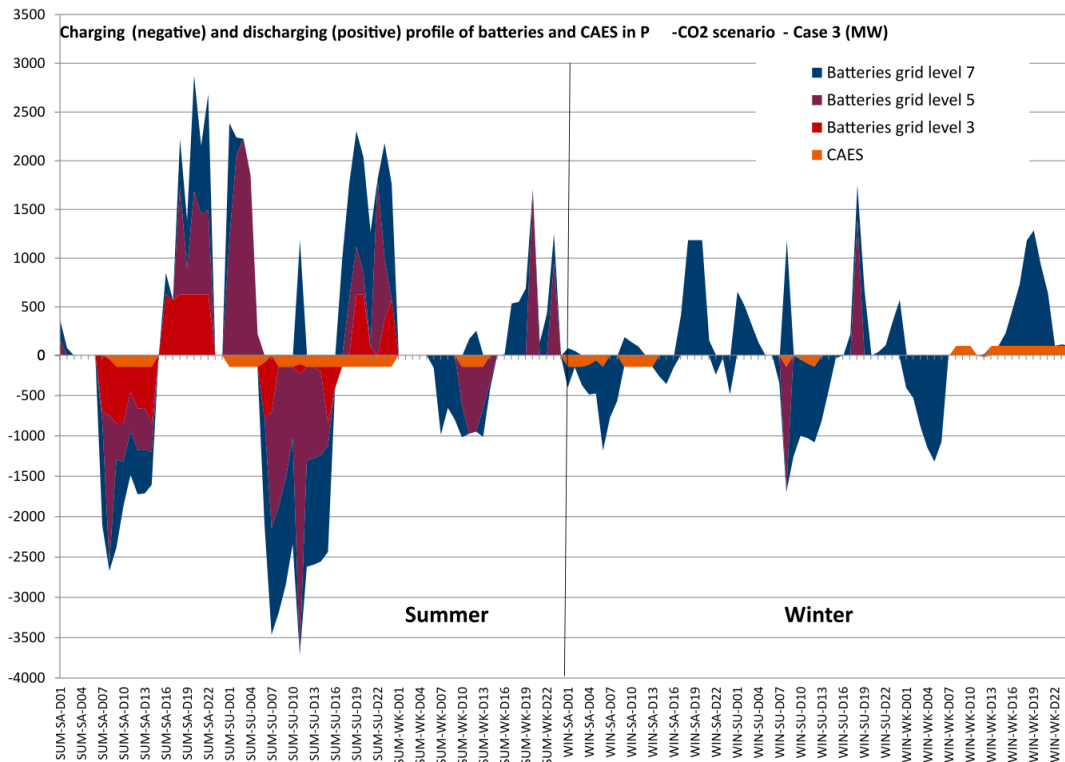

Figure 8.9: Charging (negative) and discharging (positive) profile of batteries and CAES in “P-CO2” Case 3 in 2050 (MW), for summer (left) and winter (right) (x-axis represents the typical day in each season and their hourly profile – SUM denotes summer, WIN denotes winter, SA denotes a typical Saturday, SU denotes a typical Sunday and WK denotes a typical working day, while D01-D24 denotes the 24 hours in a day).

Regarding the choice of storage technologies and their operation, small scale batteries connected to grid level 7 penetrate across all scenarios due to the increased uptake of solar PV in 2050. The installed capacity of small scale battery storage (in terms of power output) ranges from 1.1 GW to 1.7 GW in 2050, with utilization rates of 14 – 23% or about 1300 – 1700 hours of discharging. The operational pattern of storage is driven by the availability of solar PV, where charging occurs during hours with excessive solar PV electricity while discharging occurs in the hours when solar is unavailable. Figure 8.9 shows charging and discharging profiles of batteries and CAES in the “P-CO2” scenario for Case 3 in 2050, for a typical summer days (on the left) and a typical winter days (on the right).

The uptake of batteries connected to grid level 5 is driven by the penetration of wind and large scale solar PV and CHP plants. In this context, investments in batteries at grid level 5 mainly occur under strong climate change mitigation policy. Total installed capacity of batteries in grid level 5 for the scenarios presented in Figure 8.8 ranges between 0.2 GW and 1.0 GW with a utilization rate of 2 – 8% (or about 200 – 700 hours of discharging). They mainly operate during the summer, especially on days with low electricity consumption (e.g. Saturdays and Sundays), for balancing the excess wind and solar electricity (see also Figure 8.9).

Batteries connected to grid level 3 mainly occur when strong climate change policy is in place, in order to complement pump storage in balancing the electricity supply and demand at the high voltage grid levels. Grid level 3 batteries are mainly needed when pump storage participates in

other markets (e.g. in international electricity trade and in ancillary services), or in case that pump storage plants are unable to provide storage services due to water management constraints. Consequently, due to their secondary role in storage, the utilization rate of batteries connected to grid level 3 is low (1 – 4%) while their installed capacity is about 200 MW.

Compressed air energy storage (CAES) is used for both hourly and monthly storage. About 100 MW of CAES is installed across all scenarios in Ticino. In summer, electricity from low-cost imports or excess solar PV production is stored in CAES for usage in winter. In fact, 52% of the total electricity stored in CAES enters into the cavern during the summer. In addition, 75% of the electricity released from CAES occurs in winter. In addition to seasonal storage, hourly and weekly storage services are also provided from CAES, though mainly during spring and autumn. The average utilization rate of CAES, under the grid expansion restriction, can be very high reaching up to 46% in some scenarios. This denotes the need for seasonal storage especially between summer and winter, which are the two seasons with the highest differences in the electricity production costs.

Pump hydro power capacity ranges between 3 GW and 3.3 GW in 2050. The electricity from pump storage is 2.9 – 5.5 TWh in 2050. Since the balancing of domestic supply and demand is mainly achieved with distributed/localized solutions (batteries), the main driver for the pump hydro storage operation is the cross-border electricity trade and the arbitrage with the costs of foreign traded electricity. As it is shown in Figure 8.10, there is a strong evidence of correlation between electricity imports and charging of pump hydro power plants, as well as between electricity exports and discharging of pump hydro power plants. In those hours in Figure 8.10, when pump hydro charging/discharging exceeds international imports/exports of electricity, then the difference implies usage/release of domestic electricity. The average utilization rate of pump storage ranges from 12% to 19% (or 1000 – 1700 hours of discharging) in 2050, which is close to the historical observed utilization rates.

As already mentioned, when there is restriction in grid expansion, the location and the size of large scale gas power plants influence the level of the grid congestion and the uptake of variable electricity generation (see also WP7). This, in turn affects the requirements in electricity storage. To this end, Figure 8.11 presents the installed capacity (in terms of power output) of batteries in the three different cases regarding the location and sizes of large gas power plants and for the different core scenarios in 2050. In general, Case 11 (which reflects no investments in large gas power plants in regions 1 and 5) has higher requirements in electricity storage driven by the higher penetration of variable electricity generation and higher congestion.

Finally, Figure 8.12 presents the requirements in electricity storage with respect to the installed capacity of variable electricity generation, across all scenarios assessed in ISCHESS, in all different large gas power plants allocation cases. The pump hydro capacity remains almost constant at around 3 – 3.5 GW, independently of the amount of installed capacity of wind and solar generation. This is because pump hydro is suitable to balance the medium-to-high grid voltage levels instead of the medium-to-low voltage levels in which the wind turbines and solar PV are installed. On the other hand, the capacity of batteries is exponentially related to the installed capacity of wind and solar reflecting the suitability of batteries to provide distributed (localized) balancing of the supply and demand. In a similar manner, Power-to-X storage, also follow an ex-

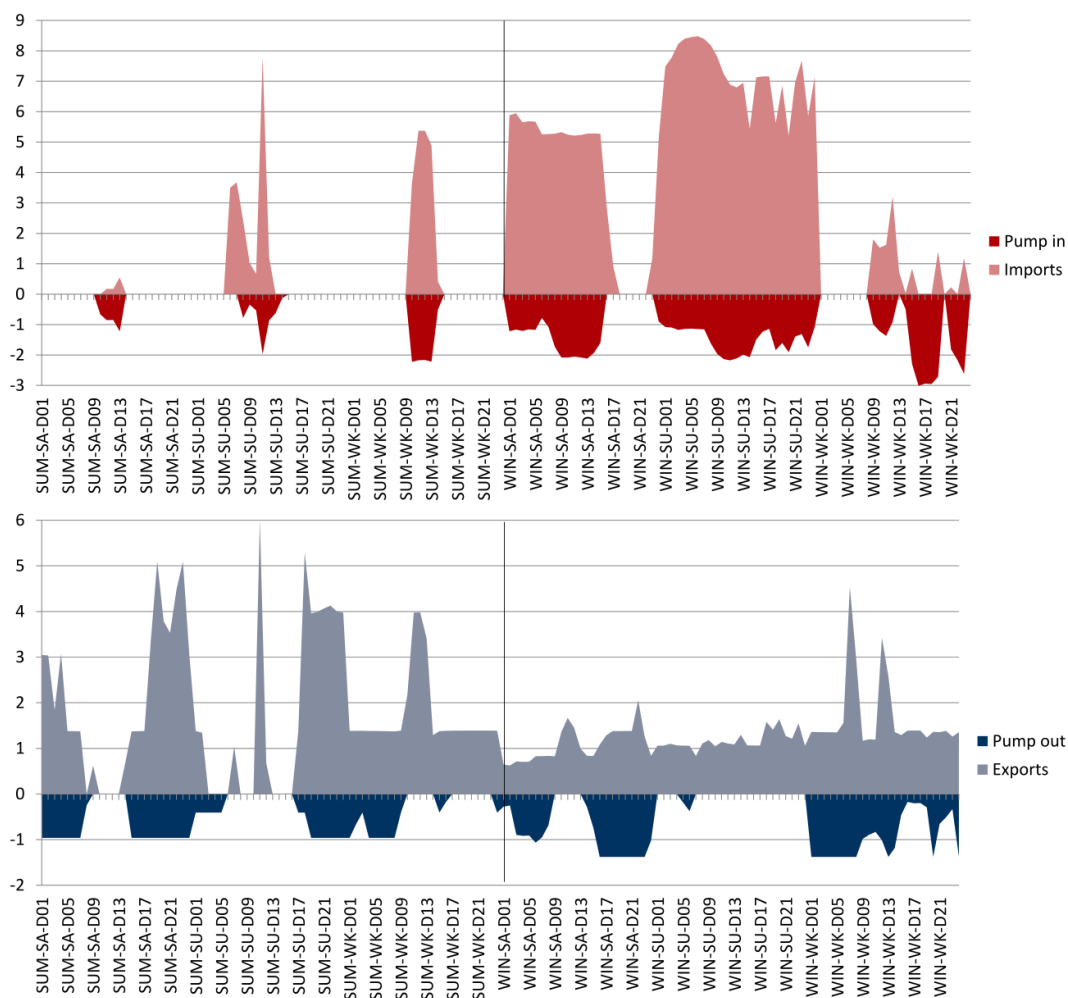

Figure 8.10: Correlation between electricity trade and pumped hydro storage operation for the “W-CO2-IMP” scenario, Case 3, in 2050 (GW), for summer (left) and winter (right) (x-axis represents the typical day and their hourly profile).

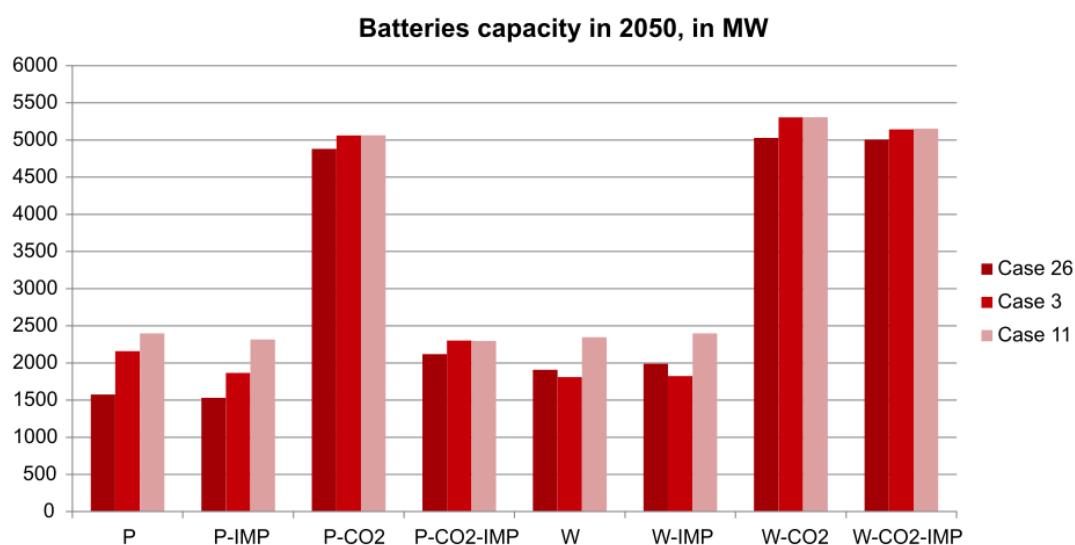

Figure 8.11: Requirements in battery storage (aggregated across different sizes) under different assumptions regarding the allocation of the large gas power plants in 2050, in MW

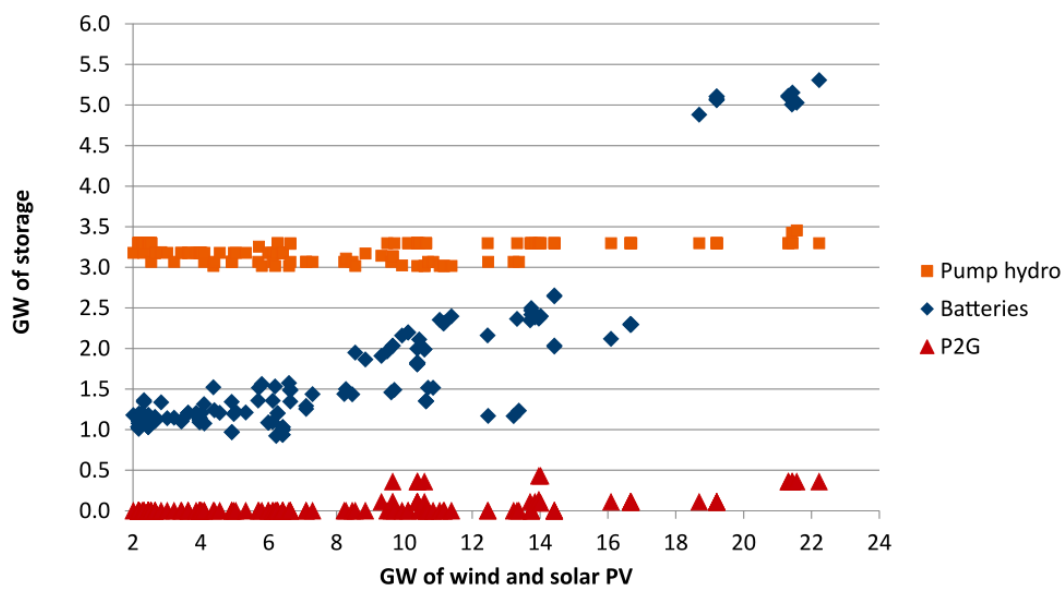

Figure 8.12: Requirements in electricity storage (GW) with respect to the installed capacity of wind and solar across all ISCHESS scenarios, without grid expansion

ponential trend due to its suitability to provide seasonal storage (see also next section).

**Power-to-X pathways** The surplus of low-cost electricity in summer due to the increased up-take of solar PV induces investments in Power-to-X pathway, as a seasonal storage option. Driven by the electricity production cost differences across seasons, 200- 900 GWh of electricity in summer are stored in order to be used in autumn, winter, and spring in mobile and stationary applications either as hydrogen or further converted to natural gas (Figure 8.12). If grid expansion is restricted, the highest amounts of seasonally stored electricity occur in the “W-CO2” and “W-CO2-IMP” scenarios, which also show the largest penetration of renewables (thus there is excess electricity in some hours) and the highest demand (which further contributes to congestion and creates the need for electricity load shifts). It is worthy to note that about 13% of the electricity generated by variable renewable sources in summer is stored to be used mainly in winter, in these two scenarios.

Figure 8.14, presents the capacity of electrolyzers (in MW of H<sub>2</sub>) for Case 26 and the “W-CO2-IMP” scenario, in 2050. About 570 MW of electrolyzers are installed, which convert 1400 GWh of electricity into H<sub>2</sub> at an efficiency rate of around 75%. From the 1400 GWh of electricity, around 938 GWh are seasonally stored (in the form of H<sub>2</sub>), while the rest are used at the time when they are produced.

**Provision of ancillary services (secondary control reserve)** The STEM model also assessed the requirements in the provision of ancillary services. Figure 8.13 presents the contribution of each option in the provision of secondary positive (upward) control reserve, which can be supplied in the STEM model by multiple options. The figure displays the maximum requirements in secondary positive control reserve and the maximum amount of reserve provided by each option, across all the 288 typical hours of STEM for the different core scenarios of Case 3 in 2050. Today,

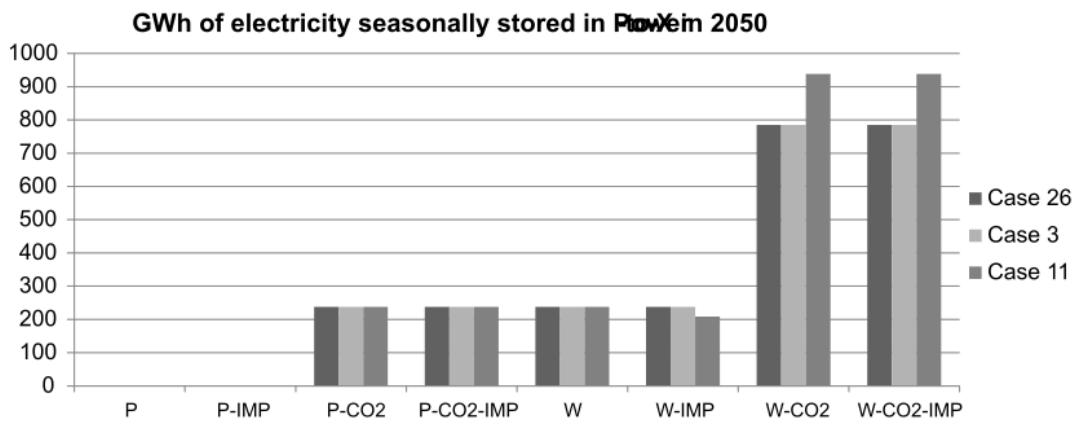

Figure 8.13: GWh of electricity seasonally stored into Power-to-X technology, for different scenarios (x-axis) and different assumptions regarding the location of the large gas power plants (Cases 3, 11 and 26) in 2050

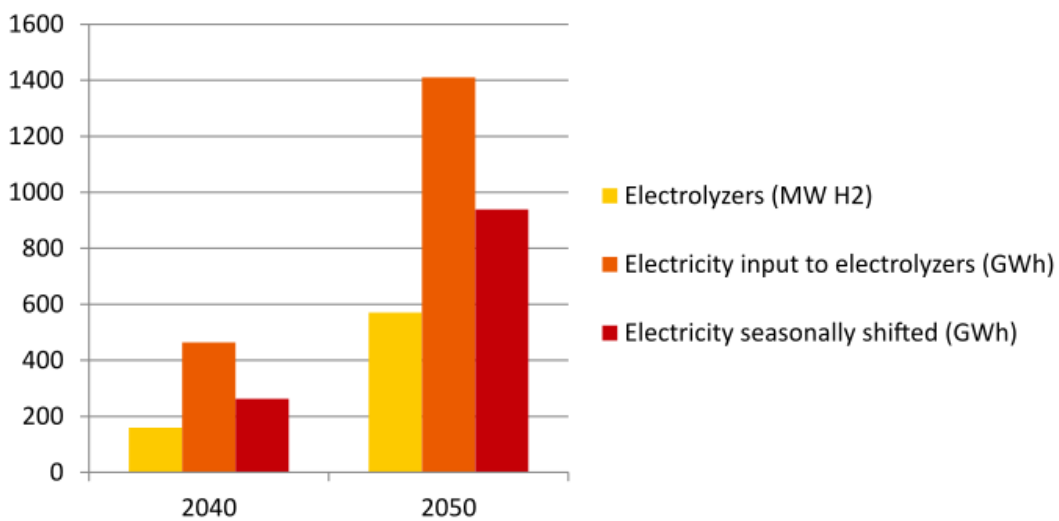

Figure 8.14: Installed capacity of electrolyzers, electricity input to electrolysis and electricity entered in electrolysis and it is seasonally shifted in the “W-CO2-IMP” scenario for Case 26, in 2050

the secondary positive control reserve requirements are about 400 MW, with the peak occurring in winter. Due to the higher penetration of solar PV, and by assuming that there is no reduction in the forecast errors regarding the electricity generation and demand in the future compared to today's levels, the requirements in secondary positive control reserve increase to close to 700 MW (almost a doubling) by 2050. Interestingly the peak occurs in summer due to the higher contribution from solar PV compared to 2015, when the peak occurs in winter. It should be noted that when electricity net imports are available as supply option, then the requirements in reserve (and consequently its provision from the different technologies) are less by 4 – 6% in the P-family of scenarios. The effect of the net imports on reducing reserve requirements is weaker in the W-family of scenarios, because of the higher electricity demand. In all scenarios, hydro dams remain the main technology for the secondary positive control reserve provision, with 490 – 640 MW entering into the reserve market (for comparison, the reserve provision from hydro today it is close to 400 MW).

Gas turbines participate in the future reserve markets with their contribution being higher when demand is high too. This is because higher demand increases reserve requirements and consequently it creates opportunities for non-hydro plants to enter into the market. When there is additionally climate change mitigation policy in place, this induces further participation of gas turbines in the reserve markets, since the high CO<sub>2</sub> prices reduce their cost-competitiveness for electricity generation and therefore unused capacity can be committed to reserve provision. For instance, in the “W-CO2” and “W-CO2-IMP” scenarios about 220 – 260 MW of large gas power plants participate into the secondary positive reserve market (which roughly corresponds to 20% of the total installed capacity of large gas power plants).

Batteries and CAES storage technologies participate in the provision of secondary positive control reserve, with about 50 MW to 110 MW combined. It is assumed, that batteries can form pools (or “virtual units”) through which they can enter into the ancillary services market [10]. As in the case of gas turbines, their contribution increases when demand is high and/or climate change mitigation policy is in place.

Finally, other thermal generation units (such as flexible CHP plants and geothermal power plants) provide secondary positive control reserve also in the form of pools (or “virtual units”). Their contribution is larger when strong climate change mitigation policy is in place, driven by the increased requirements due to both higher demand and uptake of variable electricity generation. In this context, 5- 240 MW of other thermal capacity is committed for secondary positive control reserve provision, which corresponds up to 6% of their total installed capacity.

**Dispatchable loads in the end-use sectors** Shifting of electricity consumption due to congestion and due to arbitrage in heat supply costs from electric-based options at different hours of electricity production and consumption occurs also in the demand side. In the end-use sectors, there is potential for shifting electricity load to hours with less congestion or with lower electricity costs. In this regard, water heaters and heat pumps enable consumers to use less energy during peak hours or to move the time of electricity use to the off-peak hours, e.g. night. It should be mentioned that we assume a consumption pricing scheme based on real-time pricing, which could be enabled via smart-grids. Figure 8.14, presents the amount of electricity that is stored



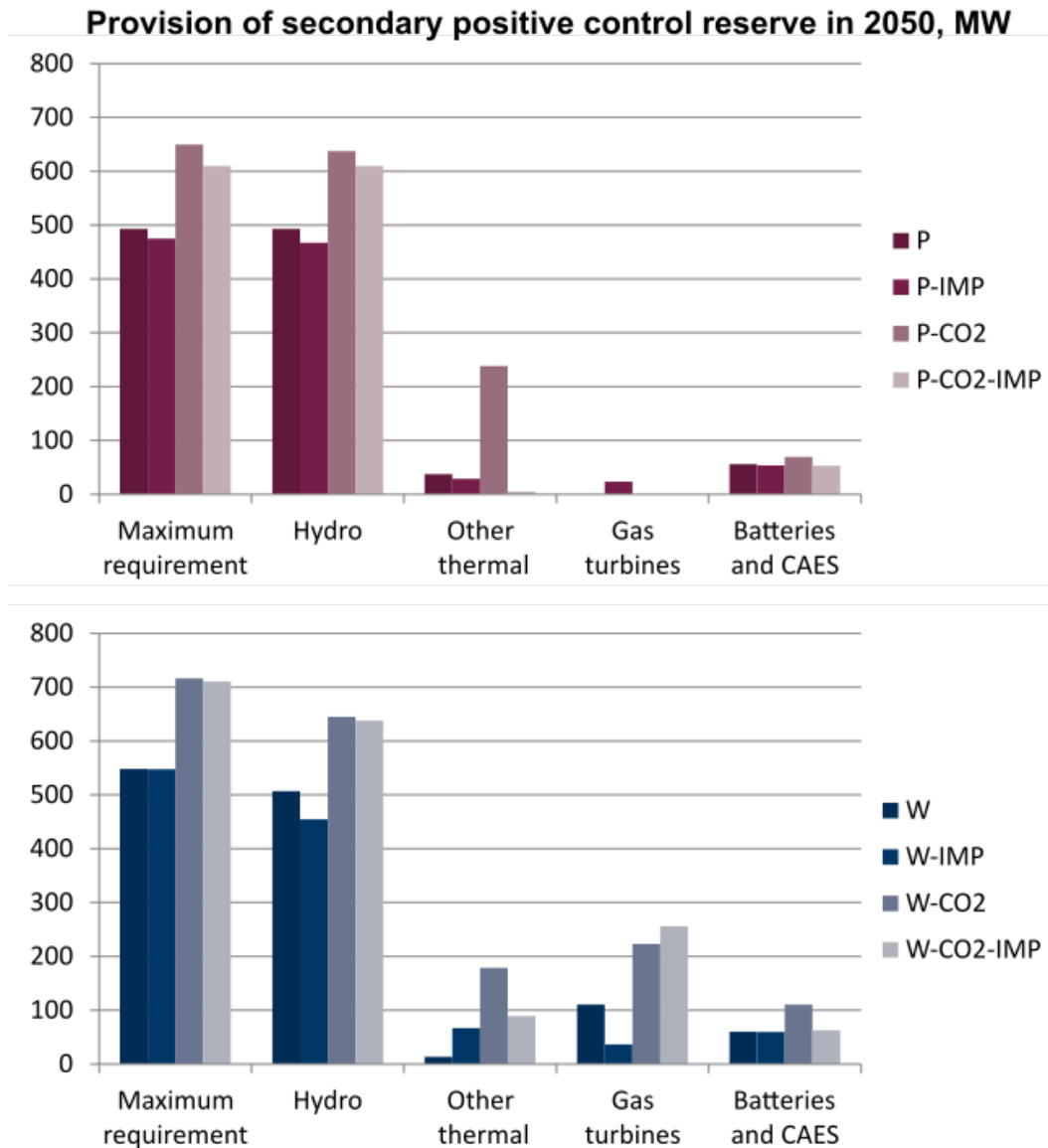

Figure 8.15: Contribution of different options in provision of secondary positive control reserve for Case 3 in 2050, in MW

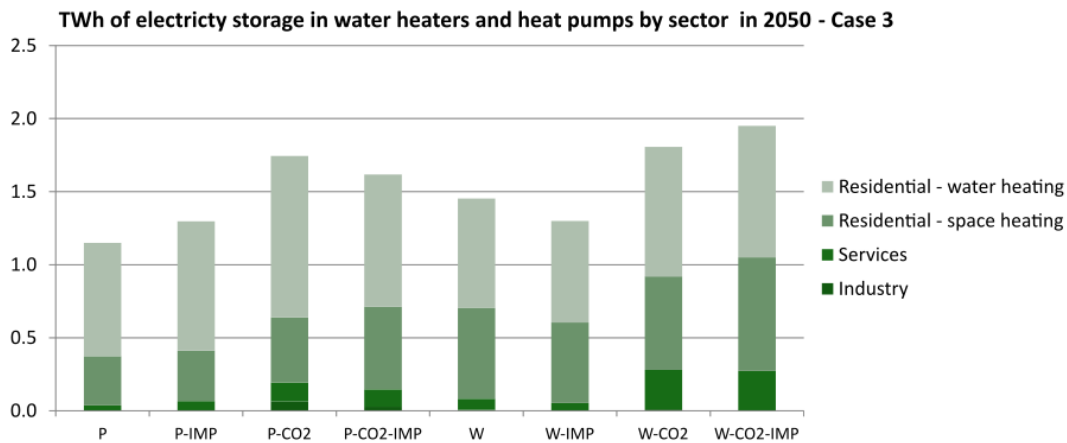

Figure 8.16: Amount of electricity shifted to different consumption hours via water heaters and heat pumps in 2050 for Case 3, in TWh

into water heaters and heat pumps. Depending on the scenario, 12% - 18% of the total electricity for water and space heating in all sectors is shifted through water heaters and heat pumps in 2050. The highest amount of shifted load occurs when there is high heating demand and strong climate change mitigation policy.

**System cost and marginal cost of electricity** Figure 8.15 presents the undiscounted cumulative electricity and heat system cost over the period of 2010 – 2050. In the “P” scenario the cumulative undiscounted system cost is about 1150 billion CHF, while in the “P-CO2” scenario the cumulative undiscounted system cost is about 1320 billion CHF reflecting the more capital intensive pathway followed in this case, driven by investments in new technologies that achieve efficiency gains and emissions reduction. In contrast, in the “W” scenario with the higher electricity and heat demand the cumulative undiscounted system cost is more than 1300 billion CHF, while when climate change mitigation policy is in place the cost increases to slightly above 1640 billion CHF. Net imports marginally reduce the total system cost (by around 1.1 – 2.0%), with the cost reduction due to net imports is stronger when climate change mitigation policy is in place (in order to avoid the deployment of expensive domestic supply options). However, these cost reductions due to increased net imports are subject to the cost assumptions of the imported electricity from the EUSTEM model.

Figure 8.16 presents the duration curves of the long run marginal cost of electricity production for the “P” and “P-CO2” scenarios in Case 3. These are compared to the alternative when the electricity grid is not explicitly modelled, but it is represented as a copper plate. In this sense, the difference in the marginal cost between the two alternatives provides an indication about the level of congestion rents. When climate policy is in place, then the differences are higher and also congestion occurs in more hours compared to the case when no strong climate policy is considered. This is attributable to the higher electricity demand and uptake of non-dispatchable electricity generation in the “P-CO2” scenario over the “P” scenario.

By comparing the marginal costs with and without grid representation, and by interpreting the difference as congestion rents, can be inferred that congestion occurs for about 3000 hours in

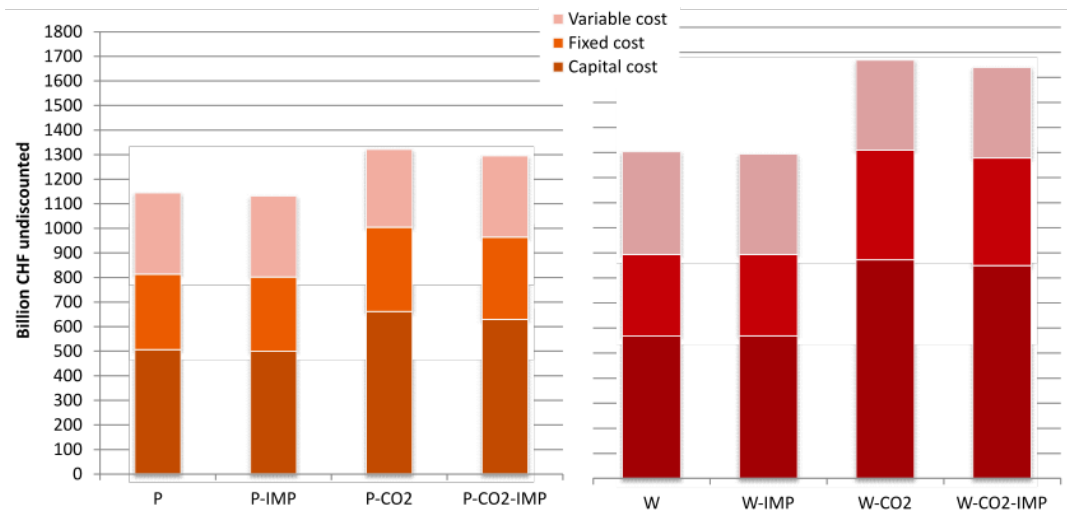

Figure 8.17: Undiscounted cumulative cost for the electricity and heat sector in Case 3 scenarios, over the period 2010 – 2050.

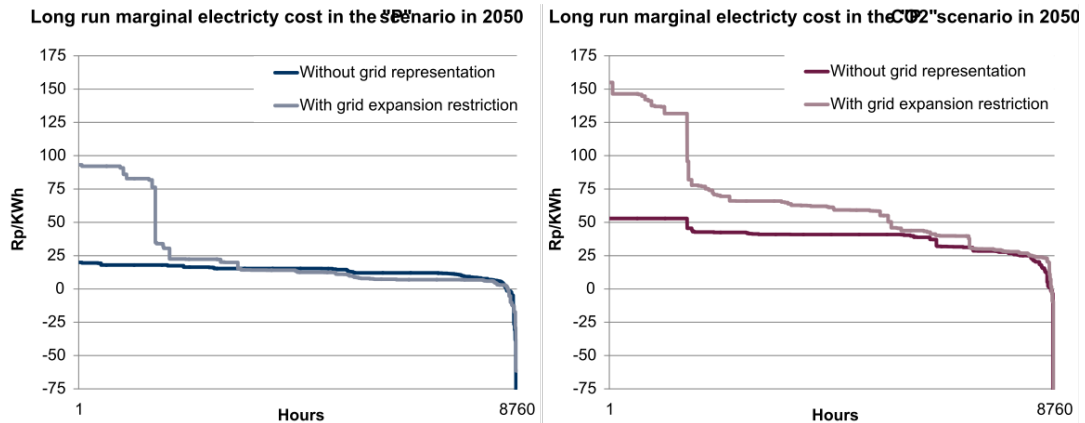

Figure 8.18: Long run marginal electricity production cost for the “P” and “P-CO2” scenarios for Case 3, with and without the electricity transmission grid constraints; the difference in the marginal costs can be used as a proxy for the congestion rent under restrictions in grid expansion.

the “P” scenario and more than 7000 hours in the “P-CO2” scenario.

### 8.5.2 B. Grid expansion (doubling the capacity of the most congested line)

In order to evaluate the role of electricity transmission grid infrastructure, we conduct a dedicated analysis in which we assume the capacity of the most congested line to be doubled. We mimic this grid expansion in STEM model by relaxing the electricity grid constraint with the highest dual value by doubling its right hand side which corresponds to the thermal transmission capacity of the congested line (see also WP7 regarding the implementation of the electricity grid constraints into the STEM model). The expansion is assumed to occur early from 2020, and it considers the expansion by 490 MVA of the most congested line. It should be noted that across all scenarios and cases the same congested line is expanded, since it is found that this line causes significant bottlenecks (based on the dual value of the corresponding constraint) in all scenarios assessed.

**Changes in the electricity generation mix** Figure 8.17 presents the changes in the electricity production mix and in the final electricity consumption in the P- and W- families of scenarios for Case 3, while additional insights are provided in the discussion below (and in the next subsection) for Cases 11 and 26 (see also Figure 8.41 in the Appendix).

The final electricity consumption increases in all scenarios, due to the lower electricity generation costs driven by the less congestion and reduced congestion rents (see also Figure 8.23). The increase in the electricity consumption is stronger in the residential and services sectors (and replaces fossil based heating system through heat pumps). These changes in end use sector heating system have considerable impact (benefit) on the total system cost. Across the two scenario families, the electricity consumption in the W-family scenarios increases at higher rates than in the P-family scenarios, because in the W-family scenarios the congestion level is highest under restrictions in grid expansion. For example, the congestion relief in W-family scenarios with strong climate change mitigation is in place, results in increase in final electricity consumption close to 10%, and it reaches 12% when extension of the operating license of existing nuclear power plants is also included. The increase in the final electricity consumption occurs in all different cases regarding the choice of location and size of large gas power plants. It is stronger, though, in Cases 3 and 11, than in Case 26, since these two cases had higher grid congestion levels under restrictions in the grid expansion.

The large gas power plants increase their contribution in the electricity supply due to the relief of congestion, in Cases 3 and 11, at the expense of distributed generation (mainly solar PV and to a lesser extent CHP plants). A similar trend is also seen when climate change mitigation policy is in place, in order to supply the increased demand. However, in Case 26, the generation from large gas power plants is reduced; in this case the relief of congestion actually allows more solar PV to be deployed in regions without large scale gas generation. In those scenarios with strong climate change policy the electricity generation from solar PV remains cost-competitive and reaches its maximum potential level, which was not the case when restrictions in the grid expansion are in place.

Wind electricity, which was not cost-effective without a strong climate change mitigation policy in place under restrictions in grid expansion, also increases when congestion is relieved. The increase in wind generation is stronger in the W-family of scenarios, in order to supply the higher electricity consumption. In this context, wind electricity reaches half of its total sustainable potential in the “W” and “W-IMP” scenarios, and its full potential in all scenarios with strong climate change mitigation policy. In contrast to the solar PV generation, the increase in wind electricity occurs in all cases, regardless the choice in location and size of large gas scale generation. This is because the relief of congestion in the transmission grid allows for additional investments of variable renewable generation connected to medium voltage levels and above.

Relieving grid congestion causes a reduction of electricity production costs, which results in fewer arbitrage opportunities for electricity storage. In addition, the relief of congestion mitigates the need for load shifting in order to balance supply and demand. For these two reasons, the electricity generation from pump storage, batteries and CAES declines compared to the alternative with restrictions in the grid expansion. This trend is persistent in all scenarios, regardless of the intensity of the climate change mitigation policy and the choice in location and sizes of large gas

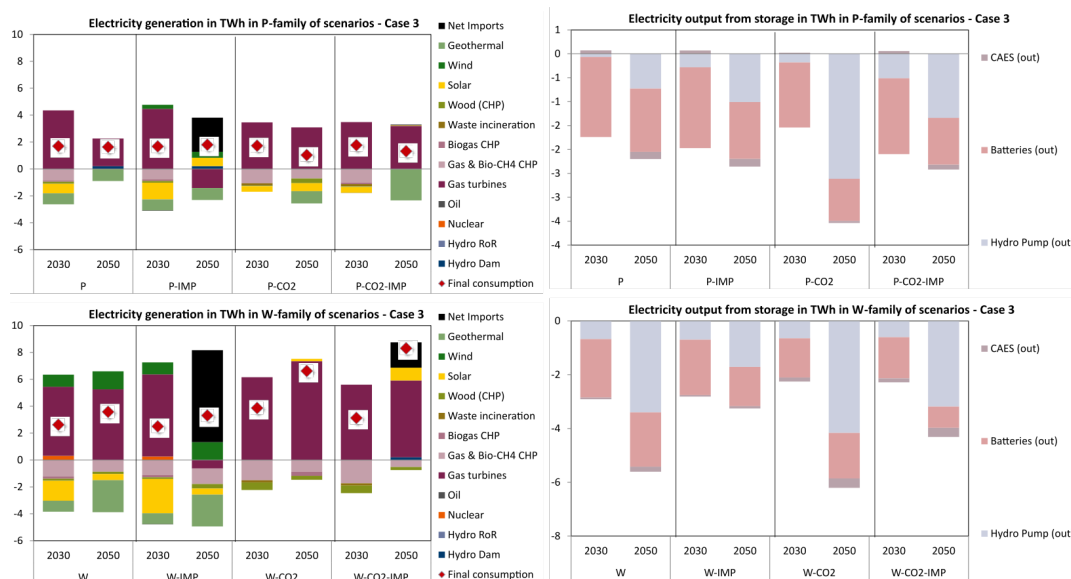

Figure 8.19: Change in electricity production and final electricity consumption when doubling the most congested line, compared to the grid expansion restriction for Case 3.

power plants.

Because of the increased competitiveness of large gas power plants (in Cases 3 and 11), as well as solar and wind electricity (in Case 26), geothermal electricity is reduced. This in turn results in increased benefits since geothermal is substituted by options with lower electricity production costs which couldn't be dispatched under restrictions in the grid expansion. In this context, the early investments of geothermal in 2030, which occur under restrictions in grid expansion, are not realized when the electricity grid is expanded. Furthermore, without strong climate change mitigation policy, geothermal electricity is not cost-competitive. Geothermal technologies reach their maximum potential only in the W-family of scenarios and under strong climate change mitigation policy.

The volume of electricity import from the neighboring countries also increases, when congestion is relieved. This increase in imported electricity partly offset expensive domestic supply and thereby reduces overall system cost. In fact, when there is grid expansion, there is no net export of electricity by 2050 across the scenarios. Enforcing the grid avoids net exports of electricity occurred for alleviating congestion in hours with high non-dispatchable generation via "dumping" excess electricity to the neighboring countries. It should be noted that the net imports of electricity that occur when the grid is expanded are at the expense of domestic electricity production and they further contribute in balancing the supply and demand, mitigating in this way the needs for electricity storage.

Figure 8.18 presents the electricity generation under different assumptions regarding the location and size of the larger gas power plants, in 2050. By contrasting Figure 8.18 to Figure 8.6, it can be seen that the alleviation of congestion leads to few differences in the electricity generation mix among Cases 3, 11 and 26. This convergence of the generation mix in the different cases, and the almost identical solutions obtained for the "W", "P-CO2" and "W-CO2" scenarios, implies that the choice of sites and size of large gas power plants is not an issue when the grid expansion is an option.

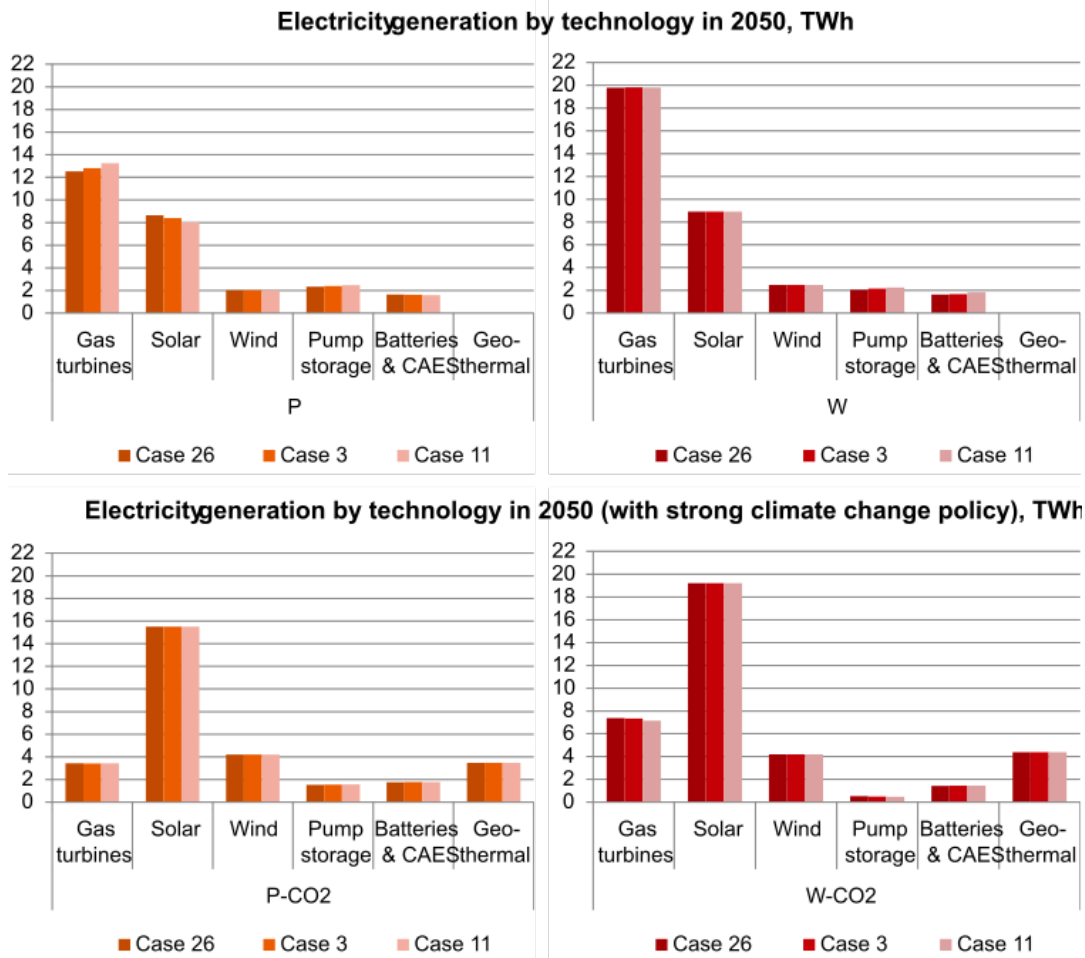

Figure 8.20: Electricity generation under different assumptions in the allocation of the large gas power plants when doubling the capacity of the most congested line.

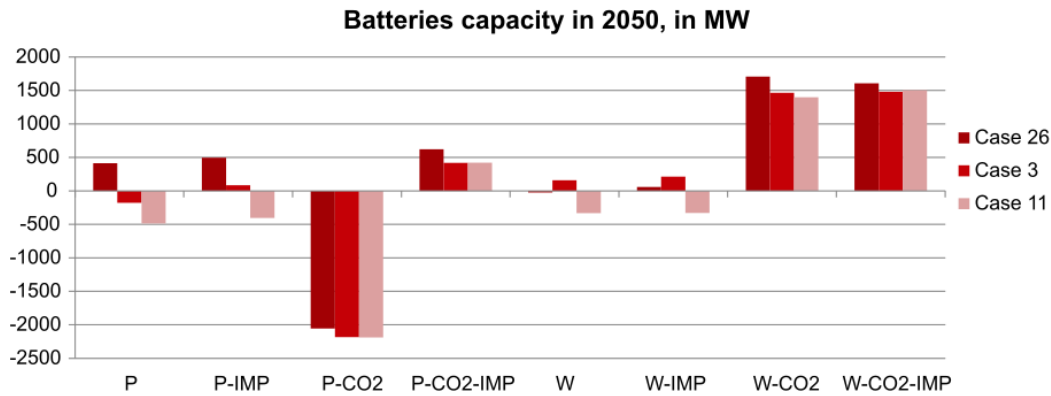

Figure 8.21: Changes in installed capacity (in terms of output) of battery storage in the different allocation cases, when doubling the most congested line compared to the grid expansion restriction.

**Changes in the electricity storage capacity and operation** Figure 8.19 presents the changes in the installed capacity of battery storage, when doubling the capacity of the most congested line, compared to the case when there is restriction in grid expansion. In the “P” and “P-IMP” scenarios, the increased investments in solar PV and wind generation in Case 26 result in additional investments in batteries in Case 26. On the other hand, the investments in battery storage are reduced in Cases 3 and 11, because of the reduction in the variable electricity generation.

In the “P-CO2” scenario in all cases there is a reduction in the installed capacity of batteries in 2050. This is attributable to the reduction of the hourly differences in electricity production cost, due to congestion relief, which results in fewer opportunities for arbitrage trade. Still, the total installed battery capacity in the “P-CO2” scenario remains higher than in “P” and “P-IMP” scenarios. In the “P-CO2-IMP” scenario, there is an increase in battery capacity across all three cases, mainly due to the increased electricity trade which allows for arbitrage between the imported and exported electricity.

In “W” and “W-IMP” scenarios, the batteries capacity does not show significant differences in Cases 26 and 3, driven by the high electricity demand. In Case 11, however, it is reduced because of the increased electricity from large gas power plants at the expense of the variable electricity generation. In “W-CO2” and “W-CO2-IMP” scenarios the installed capacity of batteries increases in all cases compared to the grid restriction expansion because of the higher final consumption, which results in higher electricity supply from variable renewable generation sources. In this case, the storage capacity is increased in order to accommodate possible variations of the electricity demand and supply, as a back-up option. In addition, higher electricity consumption and supply maintain a level of load shifting requirements in order to mitigate congestion in other grid lines.

It should be noted that in the grid expansion cases, the utilization rate of batteries is significantly lower compared to the situation when there is restriction of the grid expansion. This is mainly attributable to reduced opportunities for arbitrage trade, because of the lower differences in the electricity production costs at different hours (see also Figure 8.17).

**Changes in the provision of secondary control reserve** Figure 8.20 presents the change in the maximum contribution of different options in providing secondary control reserve when doubling

the capacity of the most congested grid line and when imposing restrictions in the grid expansion. In the P- family of scenarios, the maximum requirement in reserve stays more or less at the levels attained in the grid expansion restriction cases. In this context, hydro remains the dominant option in providing secondary positive reserve, with its capacity slightly increasing in the “P-IMP” scenario if grid congestion is relieved. Gas turbines also increased their level of participation in the ancillary services markets, at the expense of other thermal generation and batteries (as it also occurs in the electricity supply market). In the W-family of scenarios the reserve requirements increase compared to the case with grid expansion restriction, driven by the higher electricity demand and investments in renewable generation. Hydro remains the dominant option for providing reserve, with increasing contribution at the expense of other thermal generation and gas turbines. Gas turbines provide secondary control reserve mainly in “W-CO2” and “W-CO2-IMP” scenarios, where the high CO<sub>2</sub> prices reduce their competitiveness in electricity supply and, hence, there is spare capacity to commit in the reserve market.

**Changes in the Power to-X pathways and dispatchable loads** When doubling the capacity of the most congested line, the seasonal differences in electricity generation costs are much lower, due to the lower congestion rents and investments in electricity supply options with low production costs (e.g. wind) which couldn’t be dispatched under restriction in the grid expansion. In this case, investments in Power-to-X pathways as a seasonal storage option are not deployed, because the prices of electricity in winter are not high enough to payback for the Power-to-X infrastructure capital and operating costs.

In contrast, driven by the increased final electricity consumption in all scenarios, the amount of electricity shifted via water heaters and heat pumps is higher in absolute terms when grid expansion occurs compared to the alternative with restrictions in the grid expansion. However, in relative terms the share of the electricity stored in water heaters and heat pumps in total electricity consumption for heating uses is not significantly different than the case with restriction in grid expansion.

**Changes in system cost and marginal cost of electricity** Figure 8.21 presents the change in cumulative (2020 – 2050) undiscounted electricity and heat system costs between doubling the capacity of the most congested line and no grid expansion variants. On average the cumulative system cost declines annually between 0.5 and 3.0 billion CHF per year across the scenarios. The reduction is stronger in the W-family, since these scenarios have the highest grid congestion under restriction in grid expansion. It should be noted that the cost differences in Figure 8.21 refer to the total electricity and heat supply system cost from a social planner perspective. In this context, they include changes in capital and operating costs in power and heat generation capacities due to changes in investments as well as changes in fossil fuel costs (mainly for heat supply, since this sector still has a substantial share of fossil-based heat by 2050). In this sense, these cost differences cannot be merely interpreted as returns on the grid expansion investment, which would have been in this case the perspective of the grid expansion investor.

Figure 8.24, presents a decomposition of the cost reduction due to the grid expansion by different sectors. The cost reductions mostly arise from reduced capital costs in electricity and heat



**Provision of secondary positive control reserve in 2050, MW**

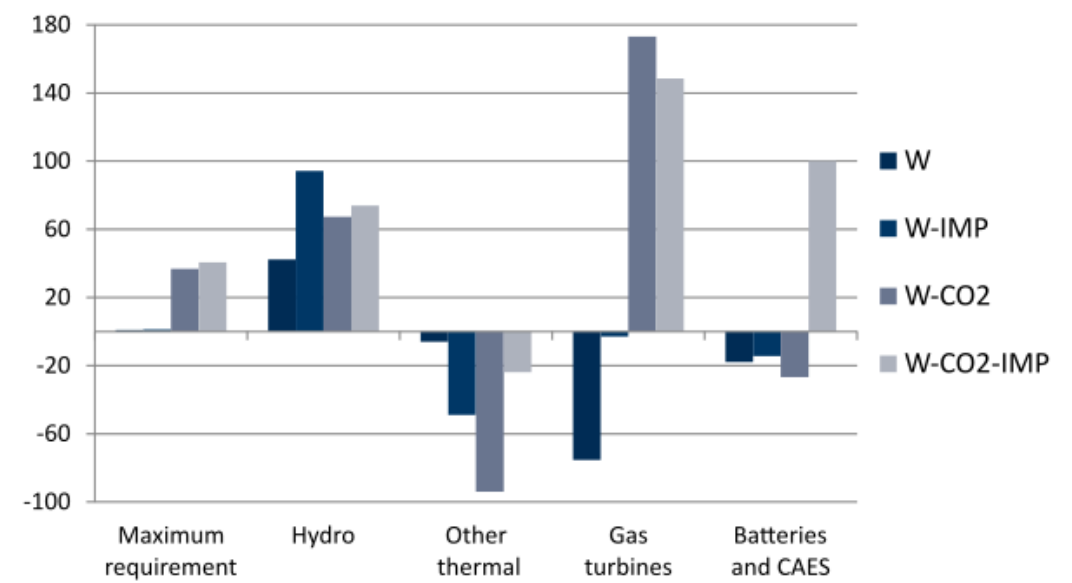
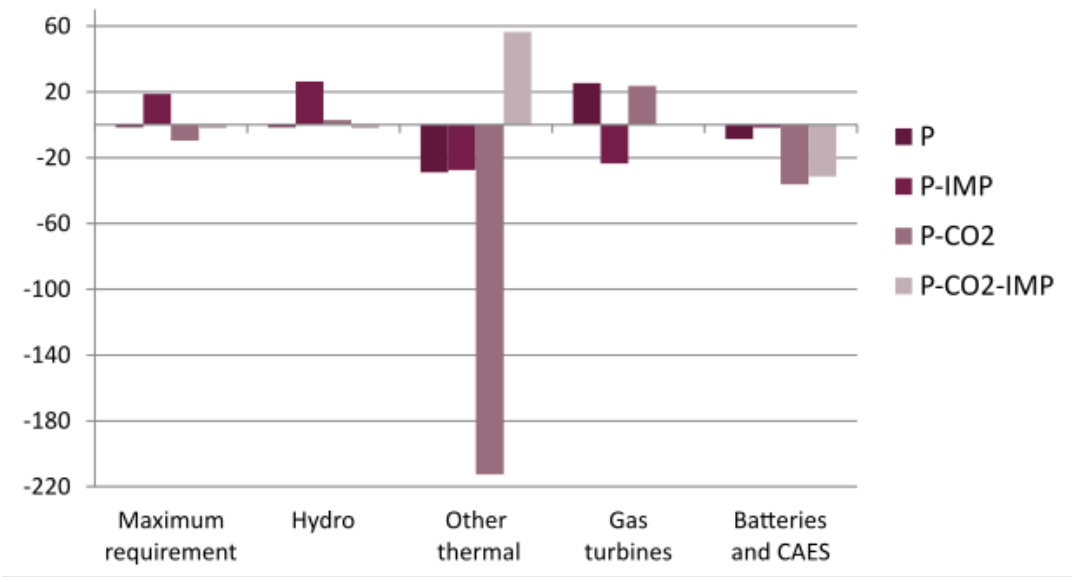

Figure 8.22: Change in the maximum contribution in the provision of secondary positive control reserve in Case 3, when doubling the capacity of the most congested line compared to the grid expansion restriction.

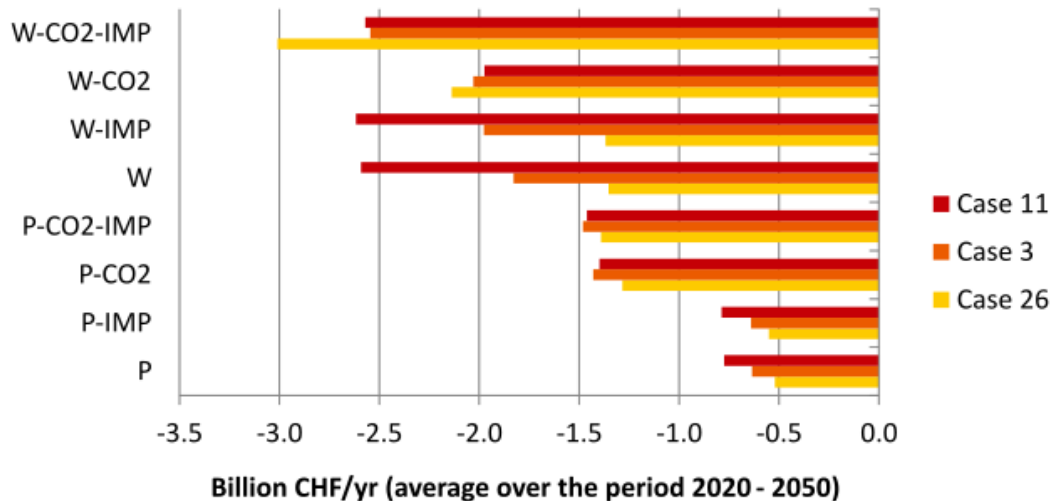

Figure 8.23: Change in average annual undiscounted system cost over the period of 2020 – 2050, when doubling the capacity of the most congested line compared to the grid expansion restriction

supply technologies (0.02 – 1.1 billion CHF/yr. on average) and from operating and fuel expenses (0.5 – 1.97 billion CHF/yr. on average). The figure presents the changes in the capital, O&M and fuel costs of electricity power plants (“Electricity power plants” label), the changes in the electricity T&D costs (“Electricity T&D” label), the changes in the heating supply capital, O&M and fuel costs (“Heating supply” label), as well as the changes in costs for electricity and fuels net imports (“Net imports of electricity and fuel” label). As stated above, the differences in the costs result from the different technology choices between the grid expansion and no grid expansion cases. For example, with grid expansion, the residential sector invests on heat pumps and thereby avoids expensive micro CHP seen in the no grid expansion cases. In addition, increased net imports of electricity reduce investments in power generation capacity and mitigate expenses in imported fuel costs. On the other hand, there are increased cost for the electricity T&D infrastructure reflecting costs due to transmission and grid access fees (due to increased amounts of electricity transferred and increased installed capacity) and investment and operating costs of the expanded line.

Figure 8.23 presents the long run marginal electricity cost when the capacity of the most congested line is doubled, compared to the grid expansion restriction case. The marginal costs obtained in the case of doubling the capacity of the most congested line are of the same order of magnitude with the case when there is no explicit grid representation in the model (see also Figure 14).

### 8.5.3 C. A case without batteries and grid expansion

We have also analysed a scenario, in which both batteries and grid infrastructure expansion were excluded. In such case, on an average 30% (20 – 50% range depending on scenario) less wind and solar PV are deployed in 2050, about 20% of which is attributable to the restrictions in batteries deployment and another 10% to the grid expansion<sup>8</sup>. The intraday variability of solar and wind

<sup>8</sup>The effect of not expanding the transmission grid is less due to the decentralized nature of solar PV.

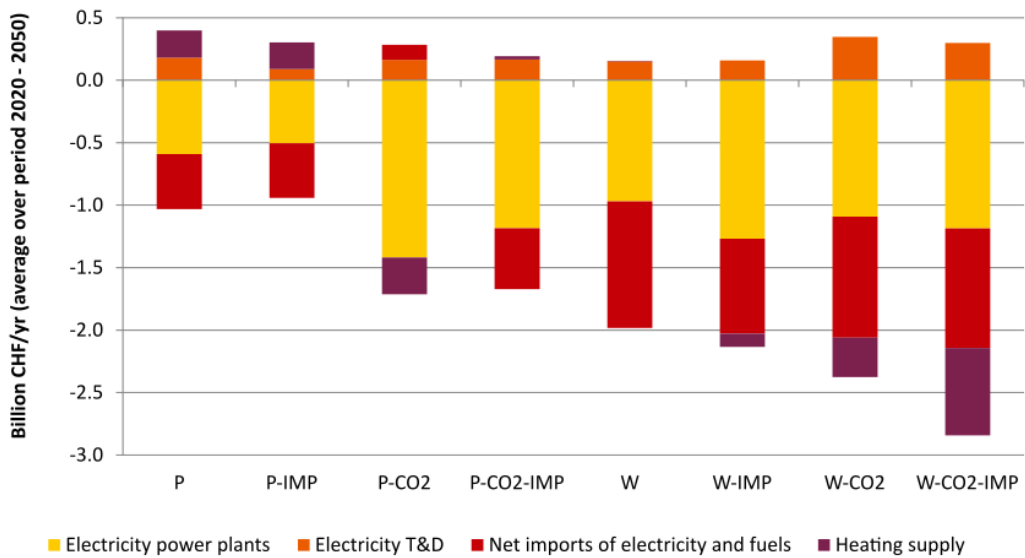

Figure 8.24: Changes in average annual undiscounted cost due to grid expansion per sector, over the period 2020 – 2050 for Case 3

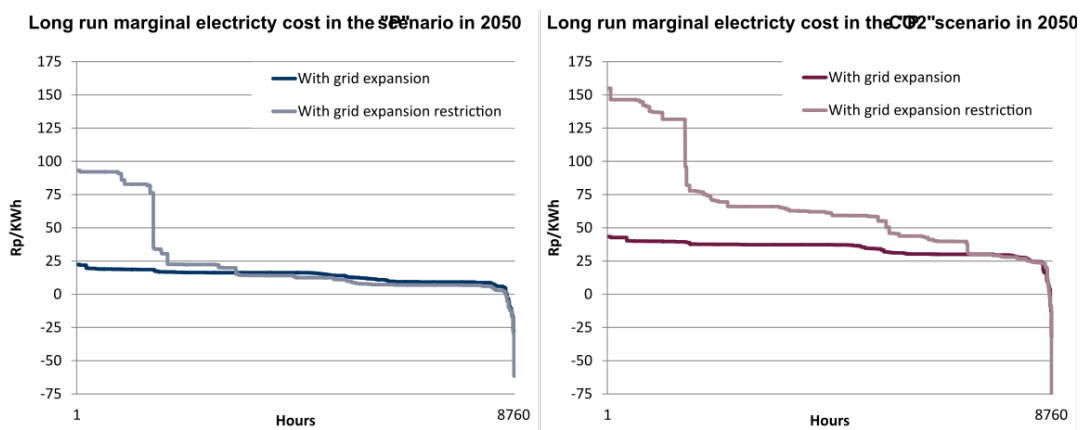

Figure 8.25: Long run marginal cost of electricity in the “P” and “P-CO2” scenarios with and without grid expansion

generation is accommodated by increased investments in flexible gas-based generation (+34% on average compared to the opposite case in 2050, and it can be doubled in some scenarios) that are underutilised (the operating hours are falling by 30% on average compared to the opposite case) and by increased cross-border trade (up to +3.6 TWh compared to the opposite case<sup>9</sup> in 2050). At the same time, the electricity demand declines by 2 - 14% (6% on average) which implies increased fossil based heating supply by 2050. The increased participation of fossil fuels both in electricity and heat supply results in higher climate change mitigation costs<sup>10</sup>, which can be up to 17% over the period of 2020 - 2050 (or +6 billion CHF/yr. on average). It should be noted that this cost figure reflects technology related costs (e.g. CAPEX, OPEX and fuel costs) and does not include any additional costs for improving efficiency in the demand sectors, for example building insulation and industrial waste heat recovery options.

## 8.6 Conclusions

The analysis of WP8 focuses on the role of the electricity grid as an enabler or barrier in investments in new electricity technologies, in view of the main objectives of the Swiss Energy Strategy. Using the STEM model, a range of core scenarios and variants was assessed providing insights about the challenges of integrating large amounts of variable (and non-dispatchable) renewable generation in the Swiss electricity system.

Two main alternatives are considered with respect to the electricity grid infrastructure: a) a no grid expansion; and b) a grid expansion by doubling the capacity of the most congested line from the analysis in (a). The results show that the implementation of the Swiss Energy Strategy objectives, and in particular the integration of new renewables, could impose significant challenges to the transmission grid, which today is already congested in some areas.

If there were to be no further grid expansion other than planned for 2025 [9], the congestion issues exacerbate in the longer run. This is because of higher electricity demand, but also by the choice of the location and size of new build large gas-based generation, which could potentially replace existing nuclear power. The inability of the transmission grid to integrate large gas power plants in some areas, enables investments in distributed generation, mainly solar PV, and geothermal (in those areas with good resources) as an option for base load electricity.

If grid infrastructure restrictions are taken into consideration, long-term marginal costs of electricity supply are persistently higher than in the case where electricity grid issues are neglected in the STEM model. By interpreting this cost difference as congestion rent, in climate change policy scenarios congestion could occur even for about 7000 hours in a year in 2050. This creates arbitrage opportunities on the one hand, and with a need for increased requirements in load shifting to alleviate congestion and to balance electricity supply and demand, on the other hand, the investments in electricity storage options are significant. In this context, batteries offer distributed (localized) balancing solutions with a deployment potential depending on the grid level to which they are connected. The uptake of battery storage is driven by solar PV (at low voltage levels), and wind and CHP (at medium voltage levels). At the same time, batteries com-

---

<sup>9</sup>This figure is comparable to the annual output from batteries when these are available.

<sup>10</sup>These cost numbers include only direct technology-related costs (CAPEX, OPEX and fuel costs) and not costs for additional efficiency measures such as insulation, heat recovery, etc.

plement pump-hydro (at high voltage levels), in particular when the latter is not available due to water availability. In addition, the high differences in seasonal electricity production costs under climate change mitigation policy and in the presence of grid congestion enable investments in Power-to-X technology as a seasonal storage option. CAES enters in the electricity sector as monthly storage with very region-specific deployment options (for instance in Ticino). We find that dispatchable loads at the end-use sectors (such as water heaters and heat pumps) contribute to ease the congestion to some extent.

Our study concludes that limitations in the electricity grid expansion infrastructure can impose high costs for the electricity sector, which can be up to 3 billion CHF per year on average. This is because the limited grid capacity hinders electrification of the end-use sectors resulting in non-cost effective options (e.g. boilers instead of heat pumps) and imported fossil fuel costs. This is particularly prominent under strong climate policy. In contrast, when there is grid expansion, the net economic benefits can outweigh the cost. In this case, neither location nor size of large gas power plants is an issue for congestion and the occurrence of congestion rents are reduced by 3000 hours. On the demand side, needs for load shifts to alleviate congestion is also reduced if the grid can be expanded. New renewables are deployed at their full potential when climate change mitigation policy is in place, which is not the case if restrictions to grid infrastructure investments exist. In addition, there is no need for early investments in geothermal electricity for base load generation, since this can be provided from large gas power plants at sufficient transmission capacity. The long-run marginal costs of electricity are much lower, due to the more system flexibility in integrating low-cost options. This increases the final electricity consumption, especially in the climate change mitigation scenarios that in turn results in lower costs for meeting the emission targets. However, the uptake of storage options is smaller in the case of grid expansion in most of the cases analyzed.

Electricity storage is important for the integration of variable renewable energy sources for electricity generation. Sensitivity analyses in which electricity storage is disabled show that compared to the cases when electricity storage is available: a) there is on average (across all scenarios assessed) about 20% less electricity from solar and wind; and on the other hand b) there is on average (across all scenarios assessed) 45% more generation from flexible gas turbines (and consequently higher CO<sub>2</sub> emissions). Power-to-X also is important for seasonal storage, since about 13% of the electricity generation from variable renewable sources in summer is seasonally stored to be used mainly in winter.

The scenarios investigated in this analysis provide enriched insights related to integration of renewable energy technologies in Swiss electricity system and related grid issues. In overall, the methodology developed in the ISCHESS project for integrating electricity grid constraints in the STEM model is a significant advancement in Swiss energy systems models. The methodology developed and applied in this project goes beyond “conventional” energy systems modelling, where the electricity grid is often neglected and the electricity transport system represented as copper plate. Thus, the coupled framework of STEM with the detailed electricity transmission network model of FEN has been proven to deliver a suitable framework for considering network aspects in energy modelling for Switzerland allowing for more distinct analysis of energy technology development and energy policy.

## 8.7 Future Work

The analysis performed in WP8 could be further improved by addressing limitations in the modelling framework and data quality. The insights obtained from WP8 could be enriched by improving: a) the dispatchability features of the framework, accounting for example for minimum online and offline operation times of the power plants, part-load efficiency and start-up and shut-down costs (currently only ramping and minimum stable operation constraints are considered in the model); b) improved electricity and load profiles in the end-use sectors; c) improvement of the representation of stochasticity in the electricity supply and demand; d) extending the spatial resolution of the model; e) allowing for endogenous optimal decisions in the location and size choices of the different electricity options, i.e. not using the exogenously defined shares; f) improved representation of batteries, by accounting for their technical limitations; g) accounting for N-2 security constraints in the grid and expanding the number of the represented grid lines; h) introducing responsive energy service demands to electricity and heat costs. In terms of data quality, grid expansion costs, cantonal resource potentials, forecast errors for electricity demand and supply are some areas which need improvement. Furthermore, environmental aspects based on the LCA performed in WP2 should be coupled with or integrated in the energy system modeling. This includes an optimization for specific environmental indicators such as life cycle greenhouse gas emissions, identification of trade-offs between costs and life cycle burdens, identification of most promising storage technologies as well as most beneficial RES integration strategies from the environmental perspective.

## References

- [1] Prognos AG. *Die Energieperspektiven für die Schweiz bis 2050 (The energy perspectives for Switzerland until 2050)*. Report. Swiss Federal Office of Energy; 2012., 2012.
- [2] UNFCCC. *Switzerland's intended nationally determined contribution (INDC) and clarifying information*. Report. UNFCCC, 2015.
- [3] et al. Voegelin P. Georges G. *System modelling for assessing the potential of decentralised biomass-CHP plants to stabilise the Swiss electricity network with increased fluctuating renewable generation (CHP SWARM)*. Report. Bundesamt für Energie (BFE), 2016.
- [4] IEA. *Energy Technology Perspectives 2016. International Energy Agency*. Report. IEA, 2016.
- [5] IEA. *IEA Energy prices and statistics database*. Report. IEA, 2016.
- [6] et al. Bauer C. Hirschberg S. *Potentials, costs and environmental assessment of electricity generation technologies*. Report. PSI, WSL, ETHZ, EPFL, 2017.
- [7] Kannan R. Pattupara R. "Alternative low-carbon electricity pathways in Switzerland and its neighbouring countries under a nuclear phase-out scenario." In: *Applied Energy* 68 (2016), pp. 152–172.
- [8] EU. *EU Reference Scenario 2016 – Energy, transport and GHG emissions - Trends to 2050*. Report. Directorate-General for Energy, Directorate-General for Climate Action, Directorate-General for Mobility, and Transport, 2016.
- [9] Swissgrid. *Netz 2025*. Report. Swissgrid, 2015.

[10] Scherer M. Beck M. *Overview of ancillary services*. Report. Swissgrid, 2010.

**Appendix – Results from all core scenarios and variants assessed for both grid expansion and grid expansion restriction alternatives**

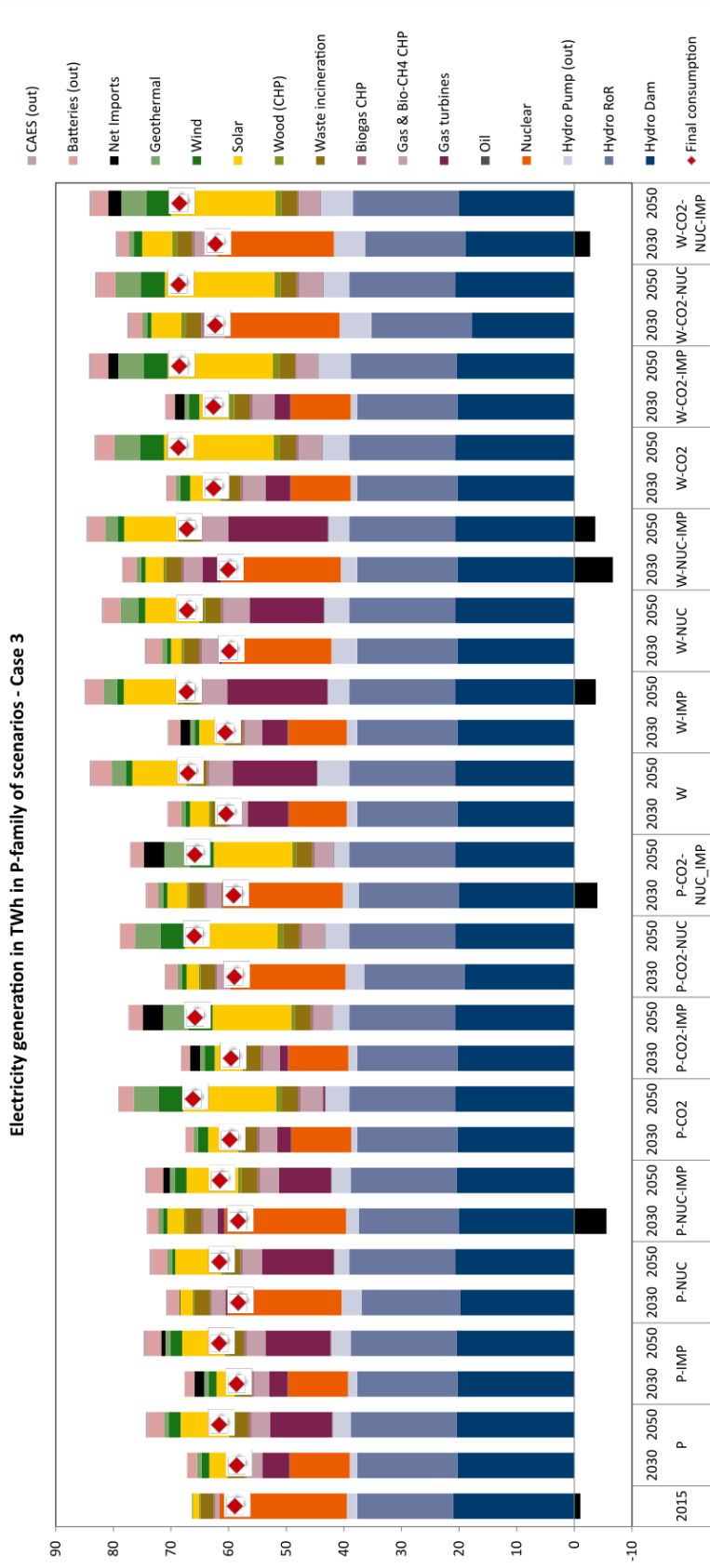

Figure 8.26: Electricity generation mix and final consumption in all scenarios and variants of Case 3, under grid expansion restriction, in 2050



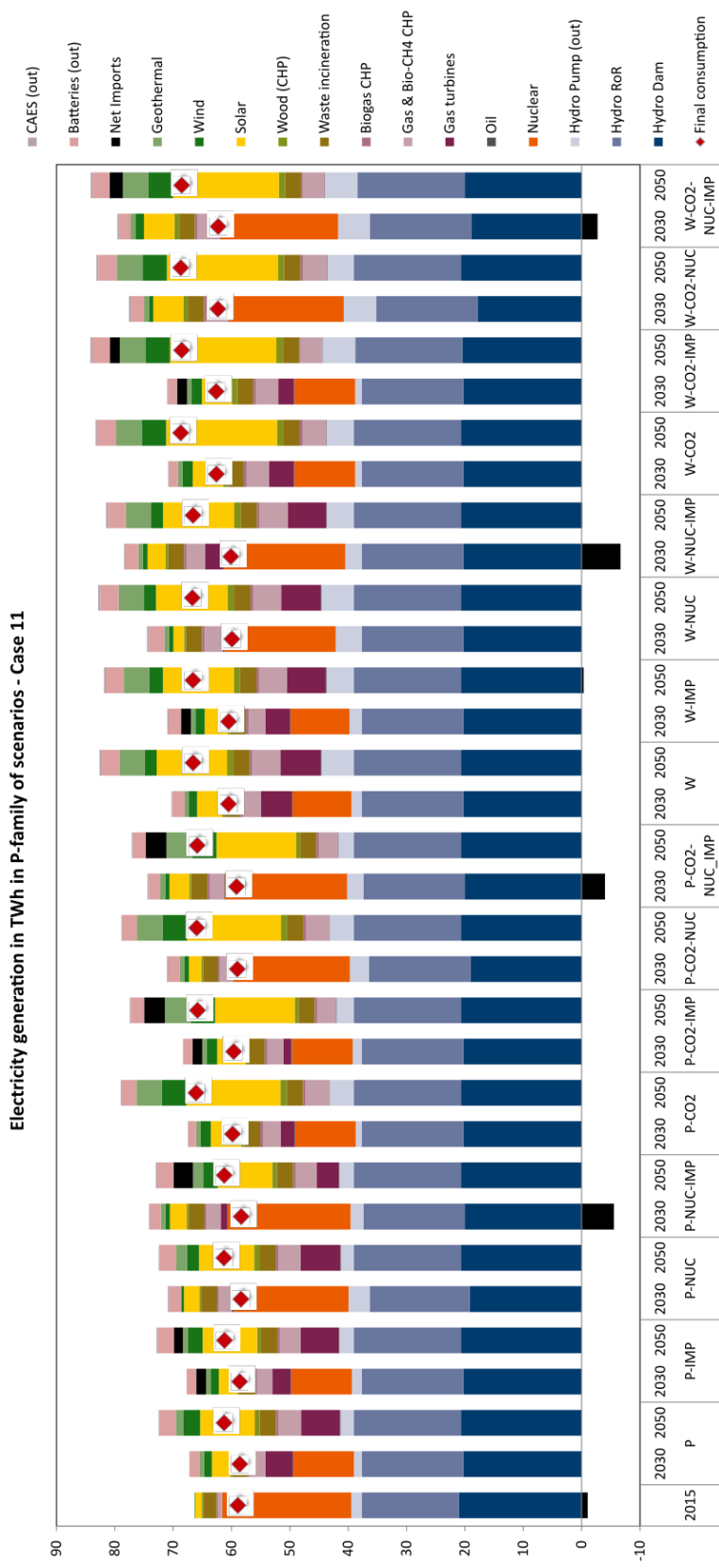

Figure 8.27: Electricity generation mix and final consumption in all scenarios of Case 11, under grid expansion restriction, in 2050

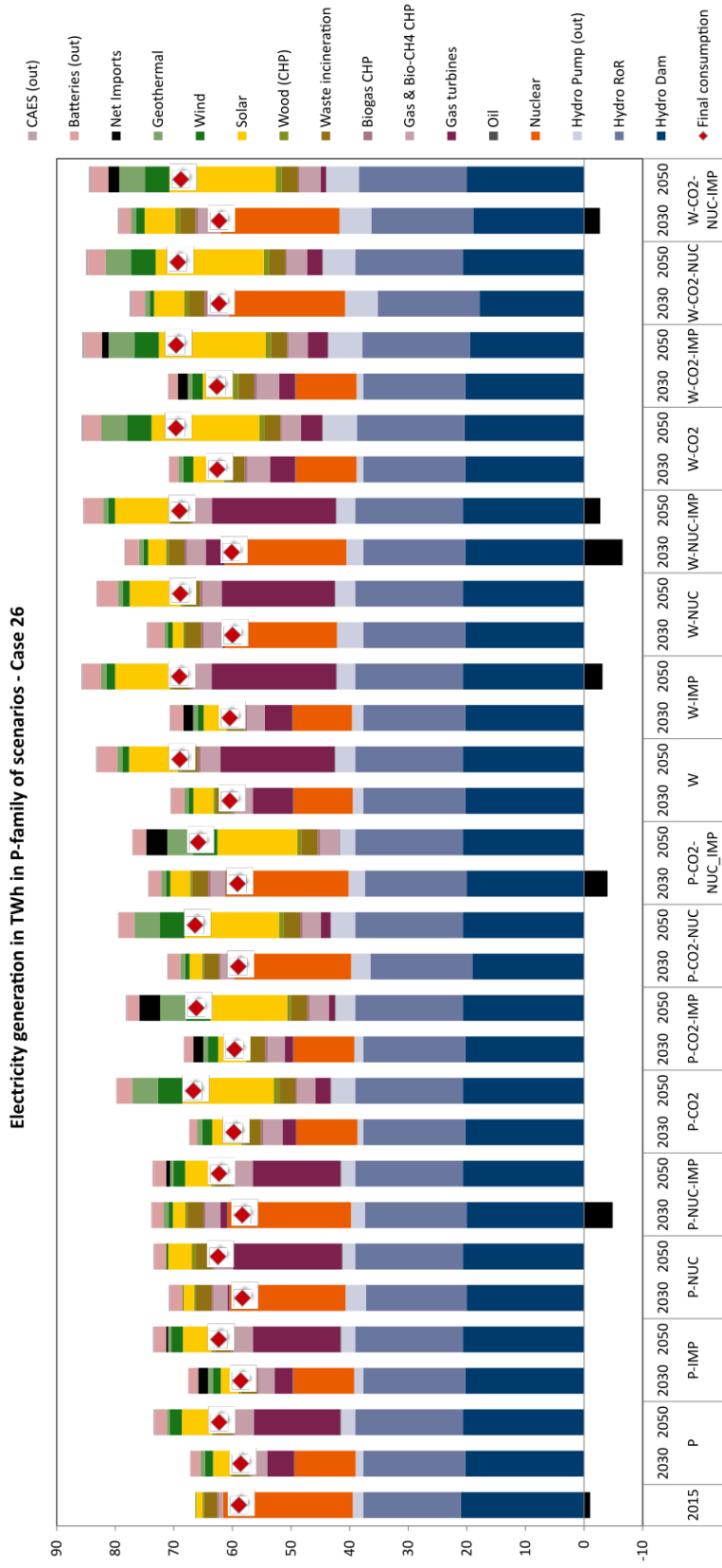

Figure 8.28: Electricity generation mix and final consumption in all scenarios of Case 26, under grid expansion restriction, in 2050

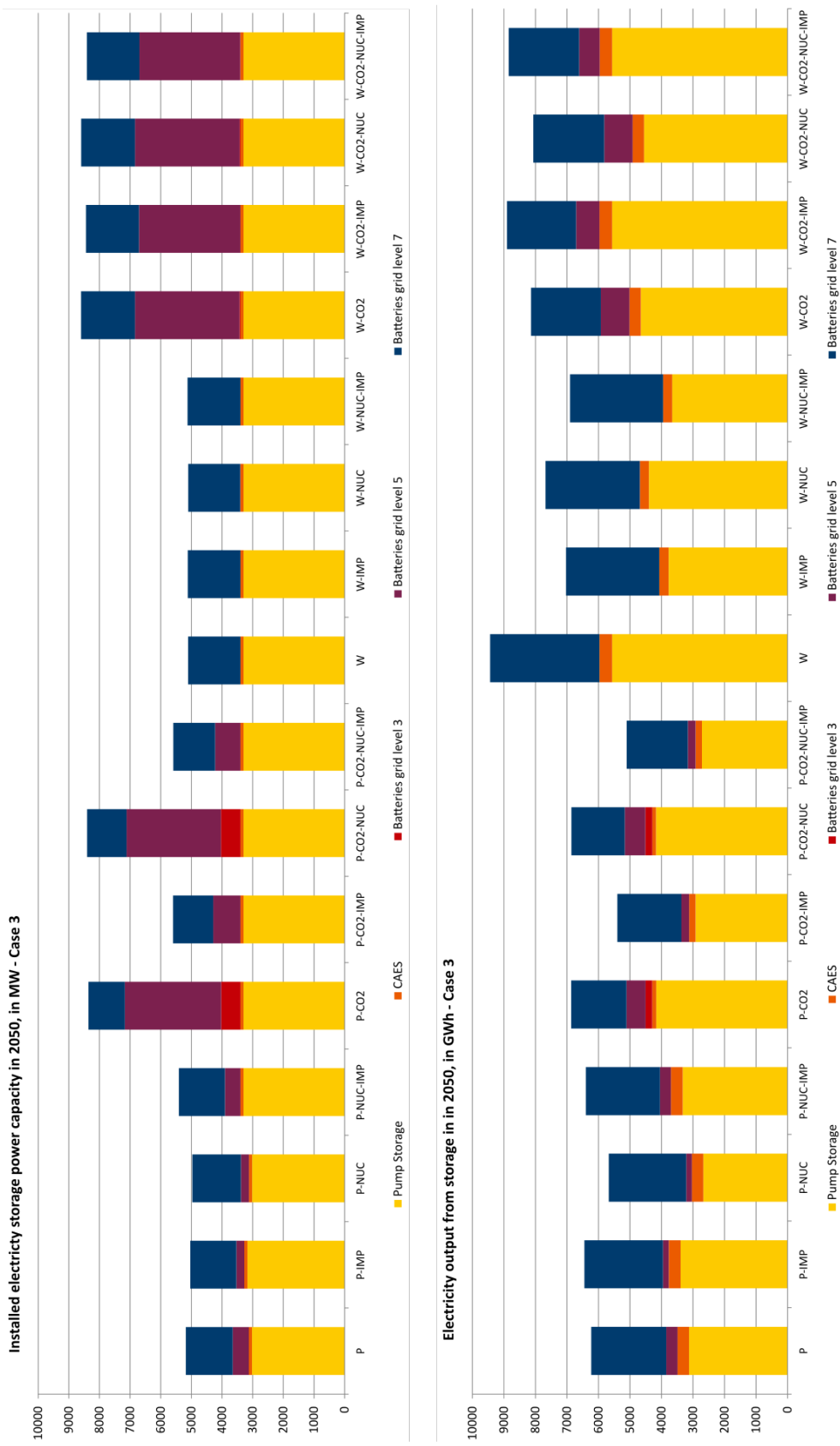

Figure 8.29: Installed electricity storage capacity and production in Case 3, under restriction in grid expansion, in 2050

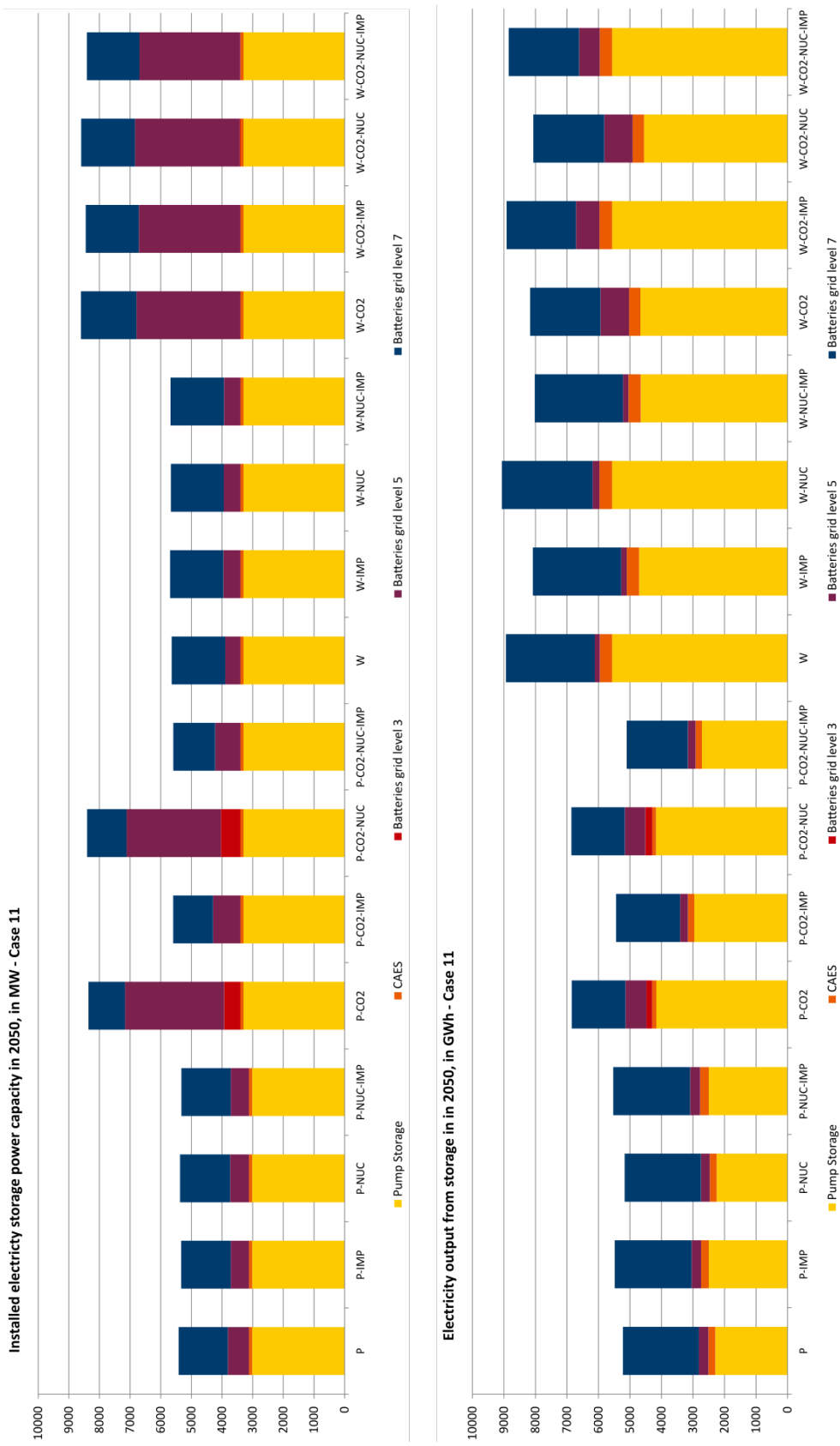

Figure 8.30: Installed electricity storage capacity and production in Case 1, under restrictions in grid expansion, in 2050

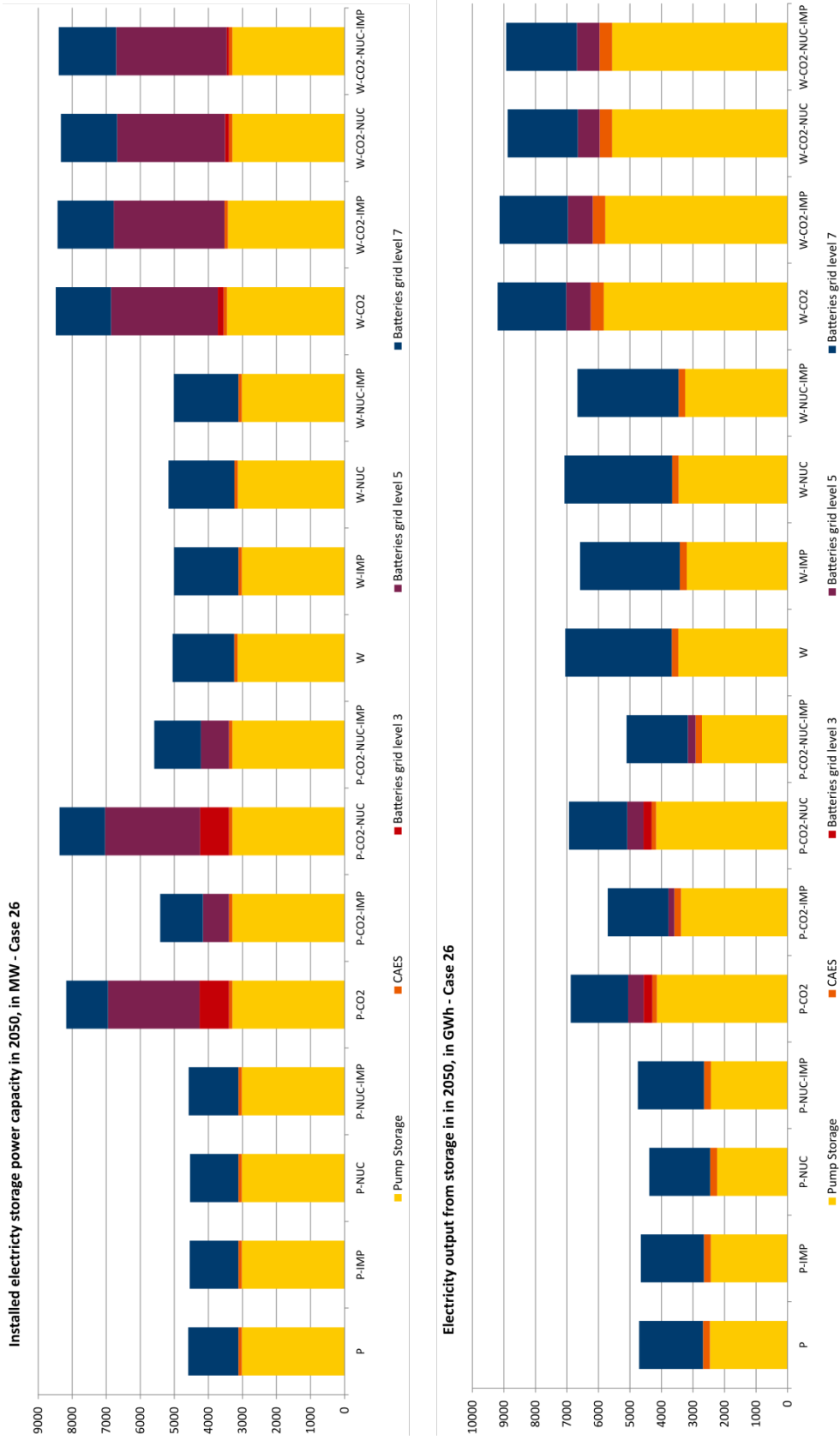

Figure 8.31: Installed electricity storage capacity and production in Case 26, under restriction in grid expansion, in 2050

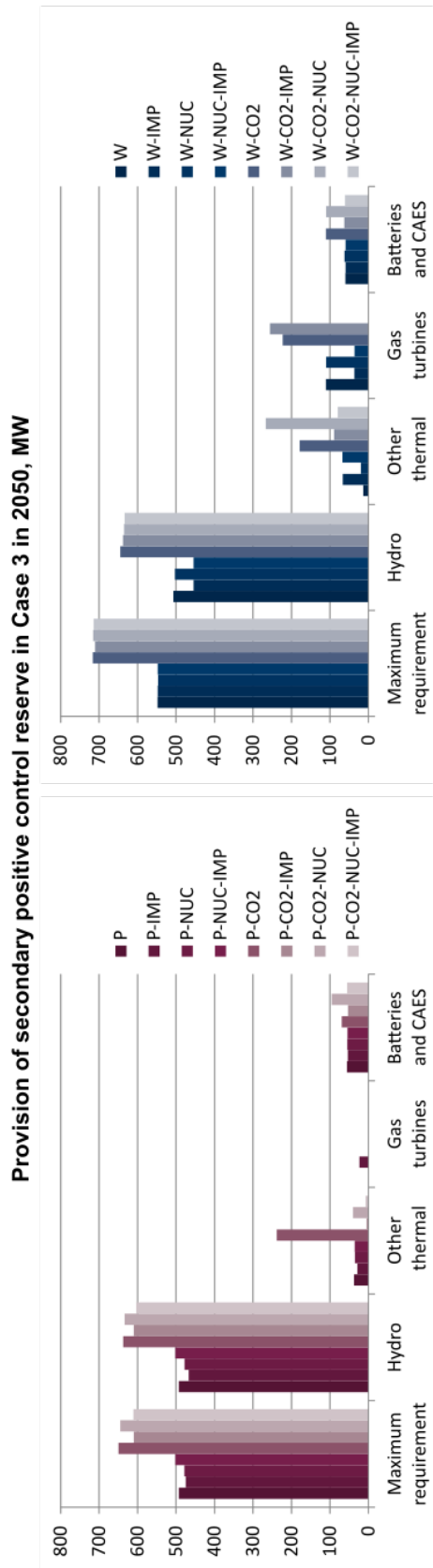

Figure 8.32: Maximum requirement in secondary positive control reserve and maximum contribution per technology in Case 3, under grid expansion restriction, in 2050

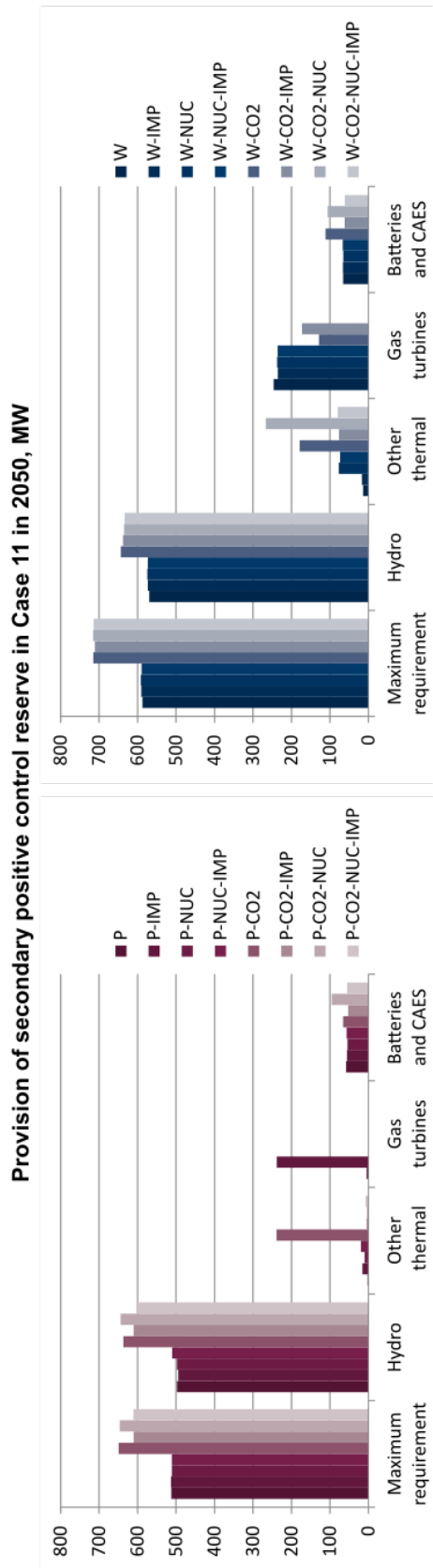

Figure 8.33: Maximum requirement in secondary positive control reserve and maximum contribution per technology in Case 11, under grid expansion restriction, in 2050

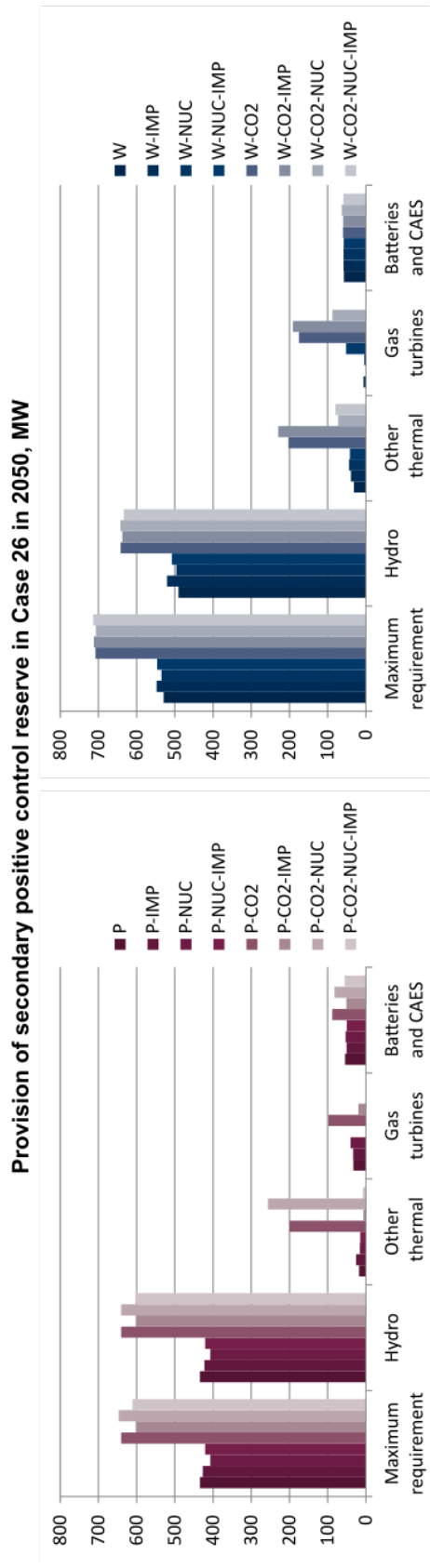

Figure 8.34: Maximum requirement in secondary positive control reserve and maximum contribution per technology in Case 26, under grid expansion restriction, in 2050



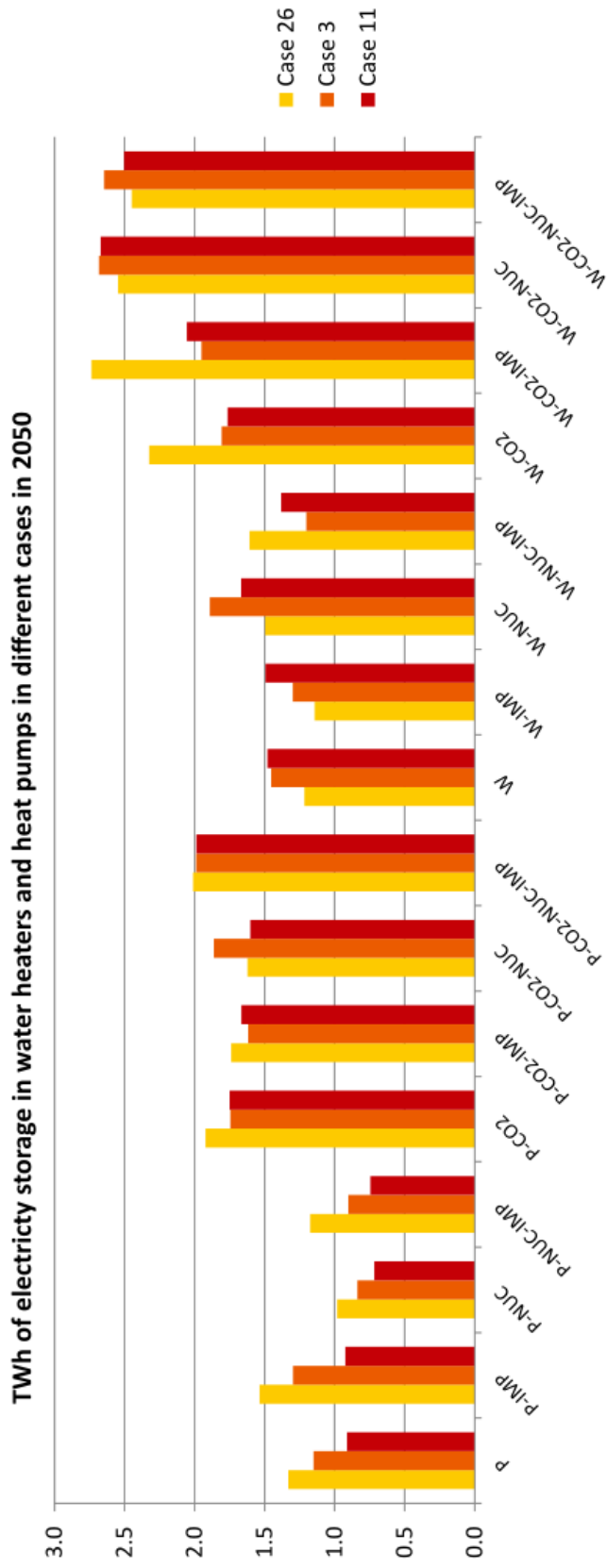

Figure 8.35: Electricity stored in water heaters and heat pumps in different cases, under grid expansion restriction, in 2050

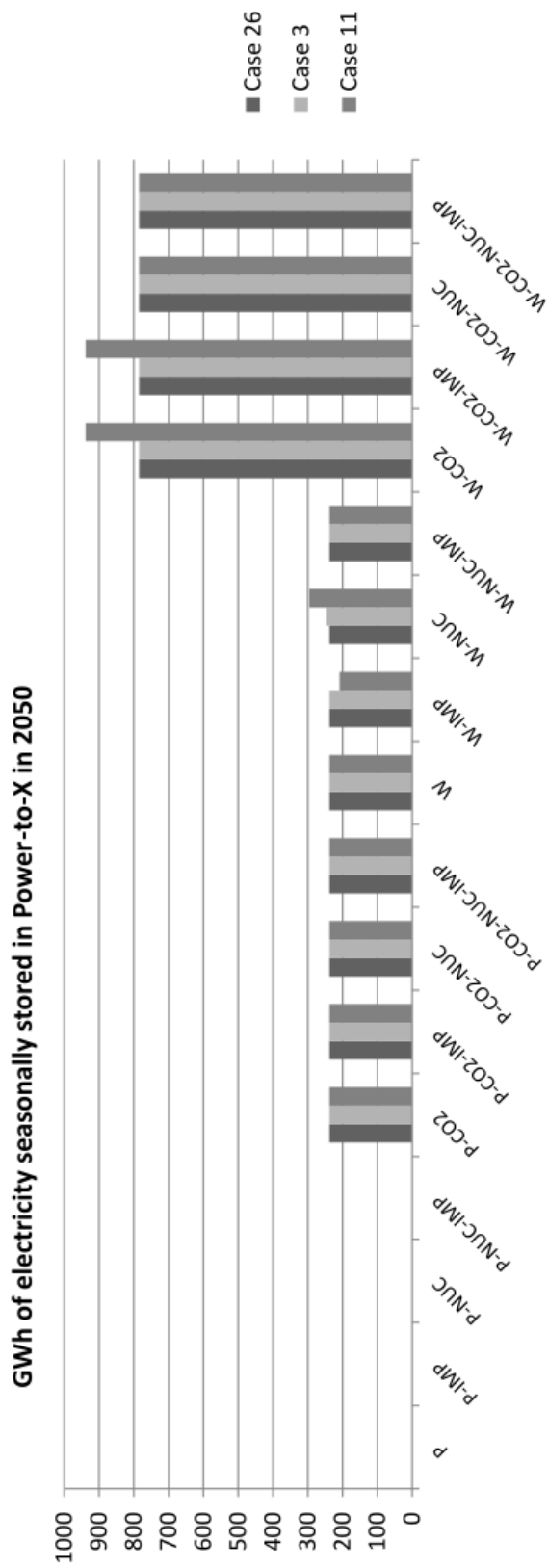

Figure 8.36: Electricity stored in Power-to-X pathways in different cases, under grid expansion restriction, in 2050

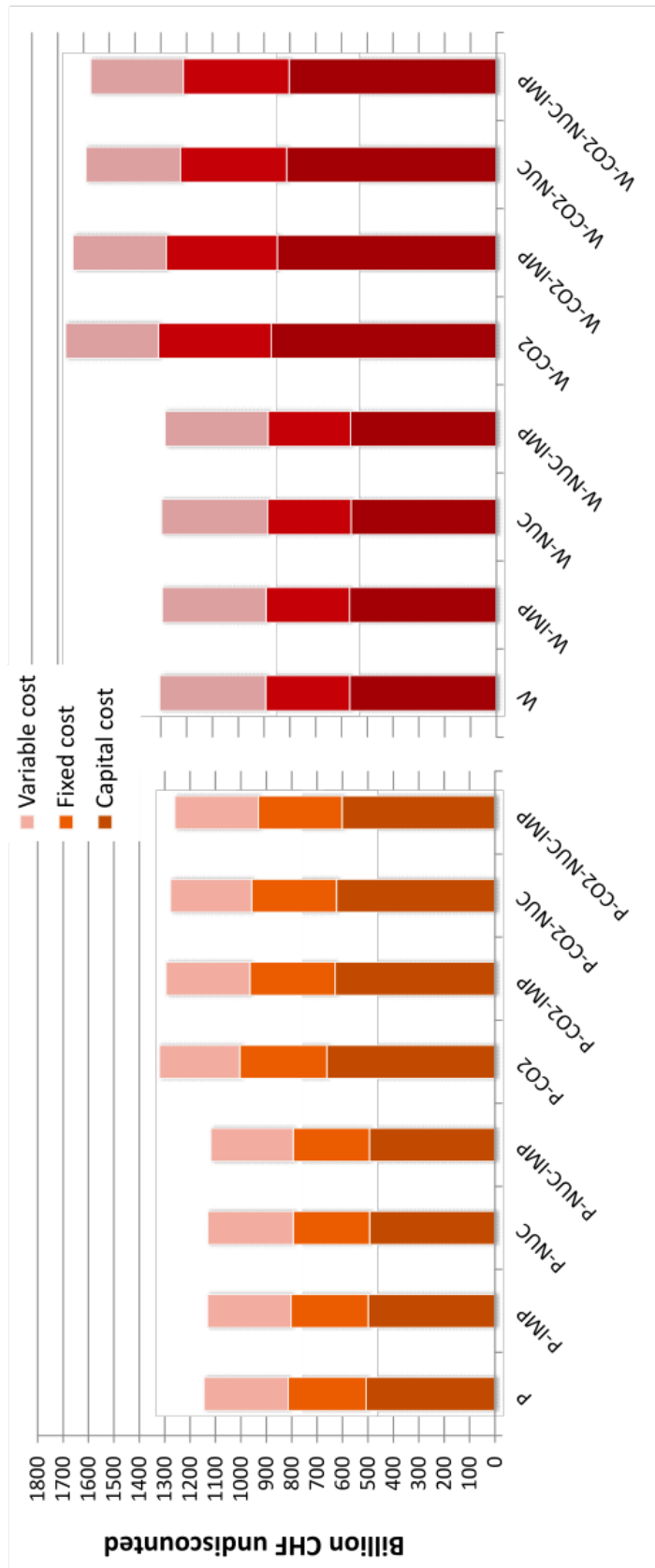

Figure 8.37: Cumulative undiscounted system cost over the period of 2010 – 2050 in Case 3, under grid expansion restriction

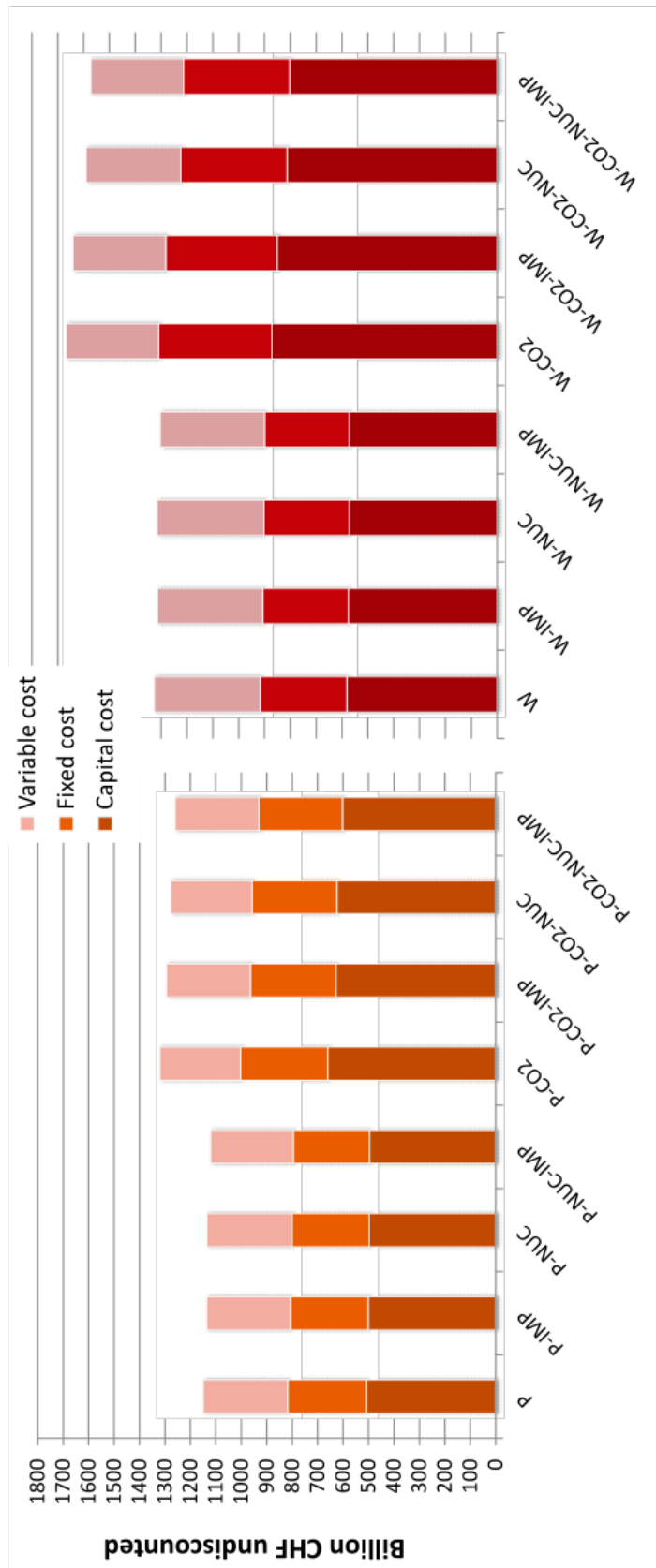

Figure 8.38: Cumulative undiscounted system cost over the period of 2010 – 2050 in Case 11, under grid expansion restriction

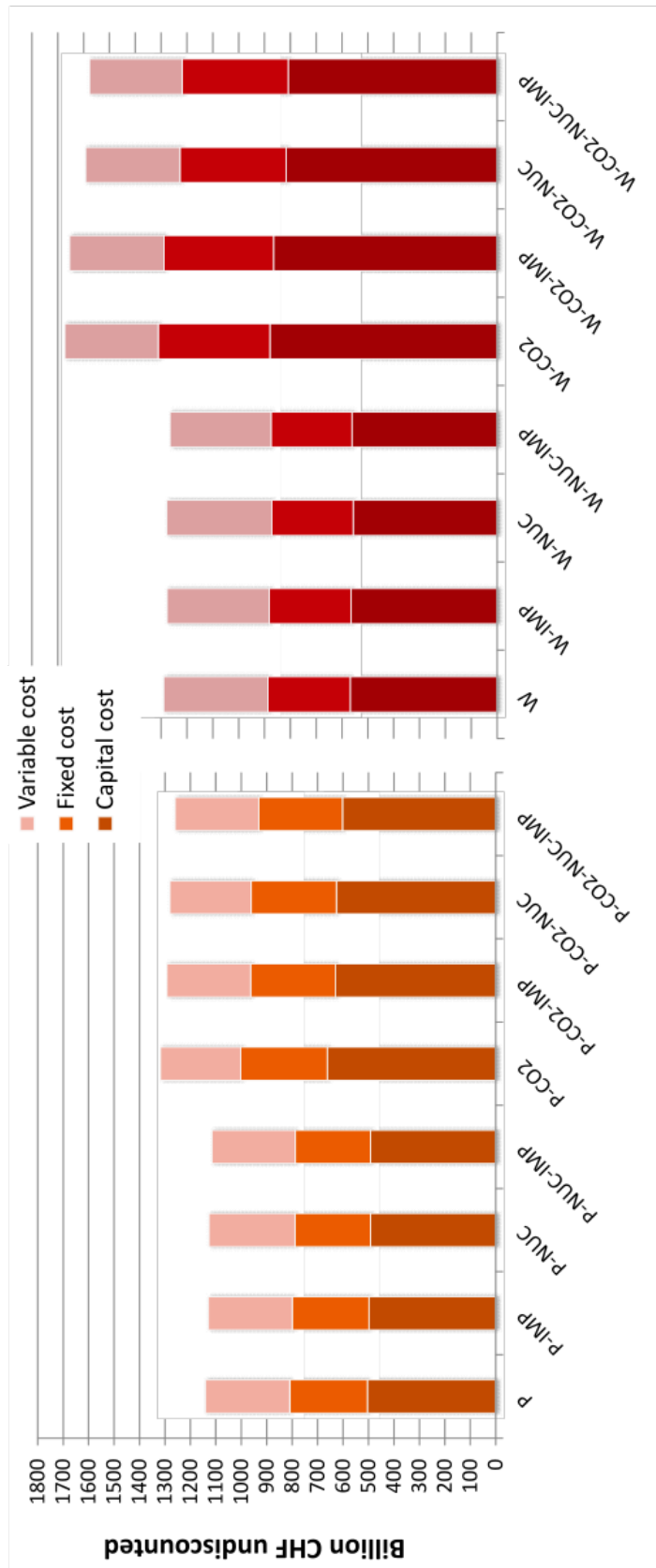

Figure 8.39: Cumulative undiscounted system cost over the period of 2010 – 2050 in Case 26, under grid expansion restriction

**Grid expansion (doubling the capacity of the most congested grid line)**

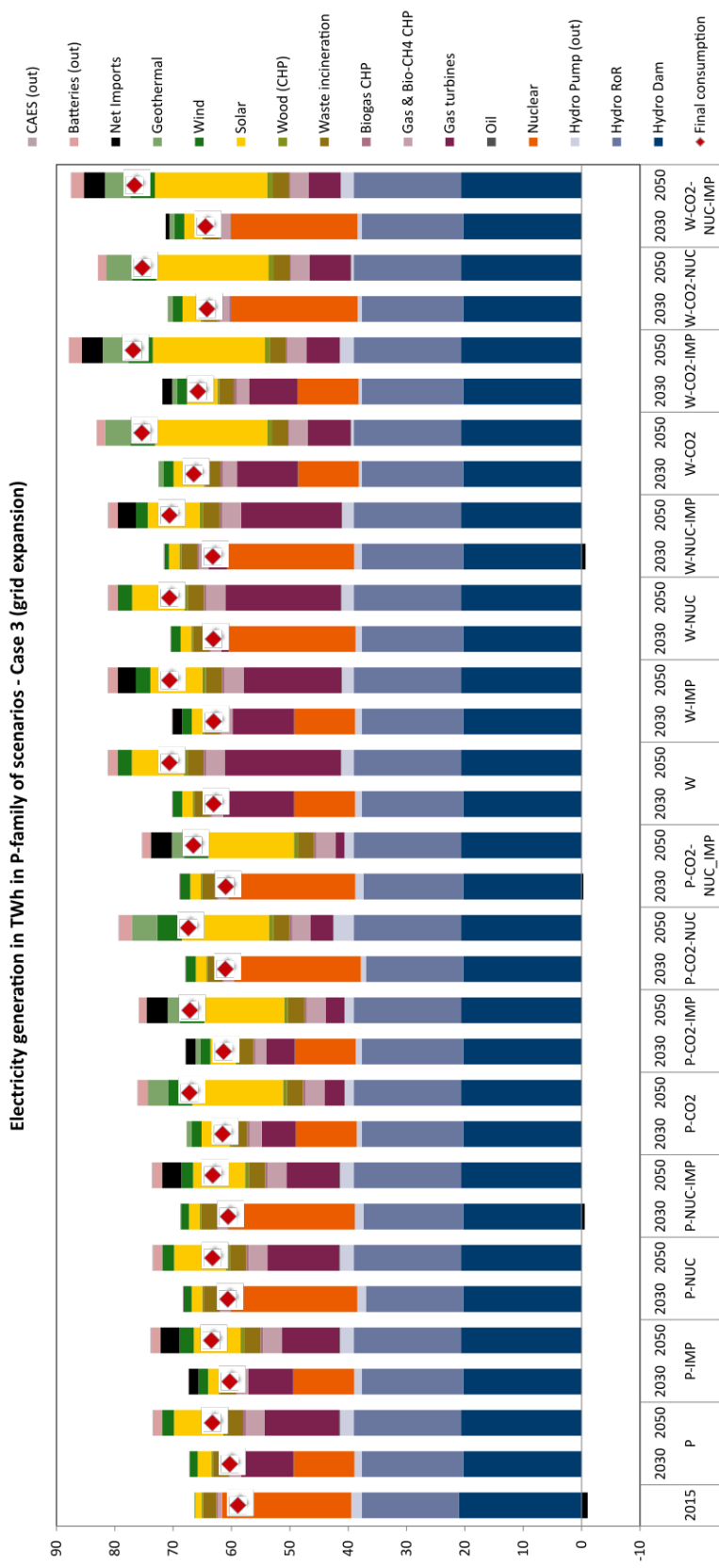

Figure 8.40: Electricity generation mix and final consumption in all scenarios and variants of Case 3, under grid expansion, in 2050

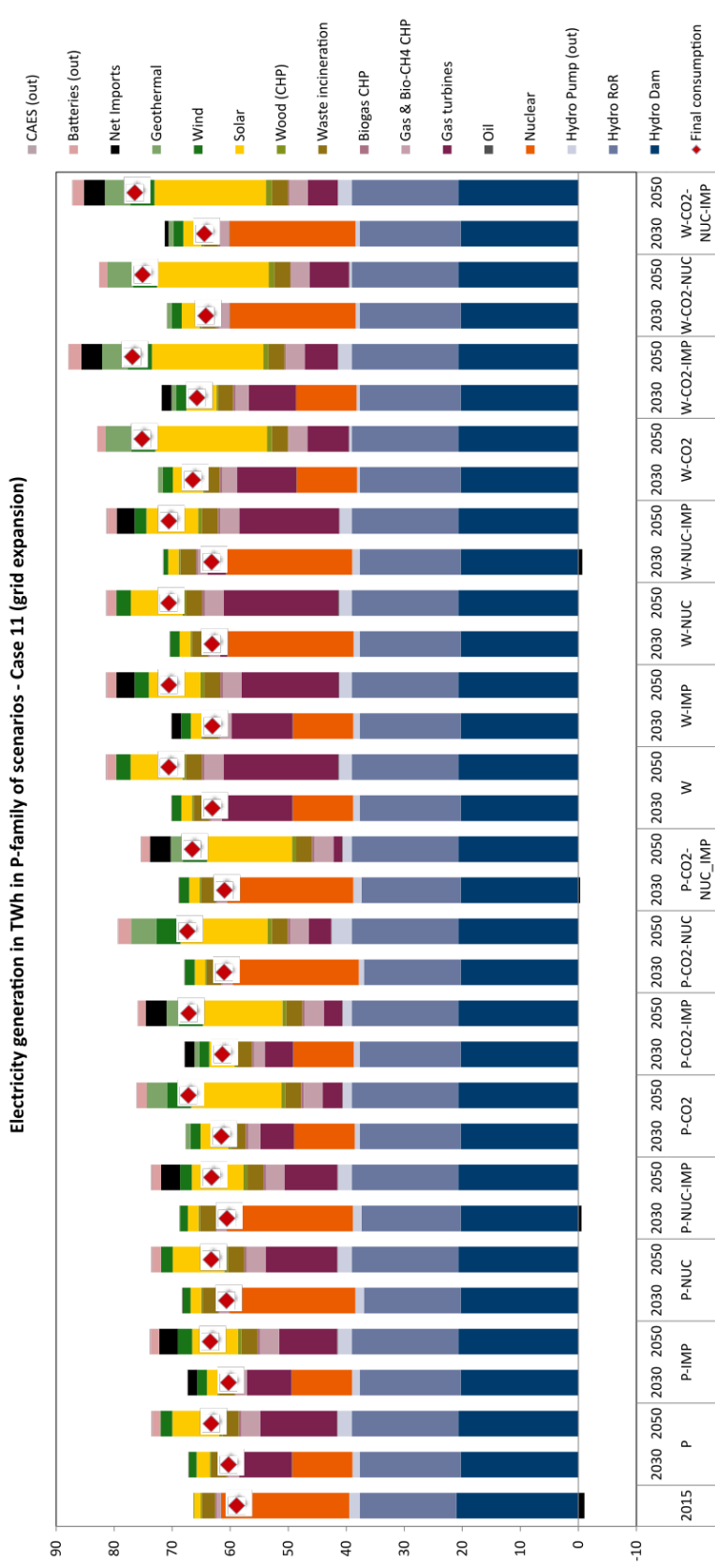
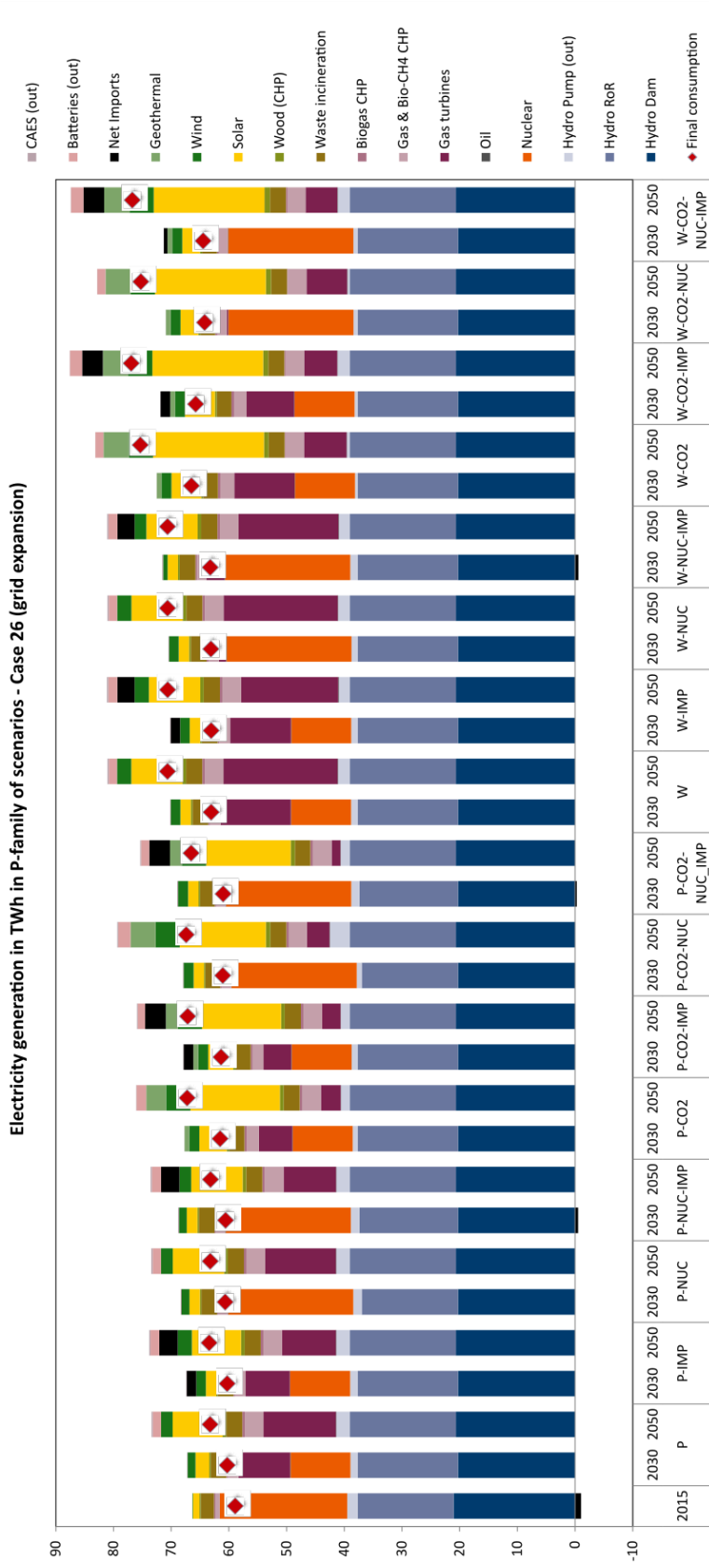

Figure 8.41: Electricity generation mix and final consumption in all scenarios and variants of Case 11, under grid expansion, in 2050





**Figure 8.42: Electricity generation mix and final consumption in all scenarios and variants of Case 26, under grid expansion, in 2050**

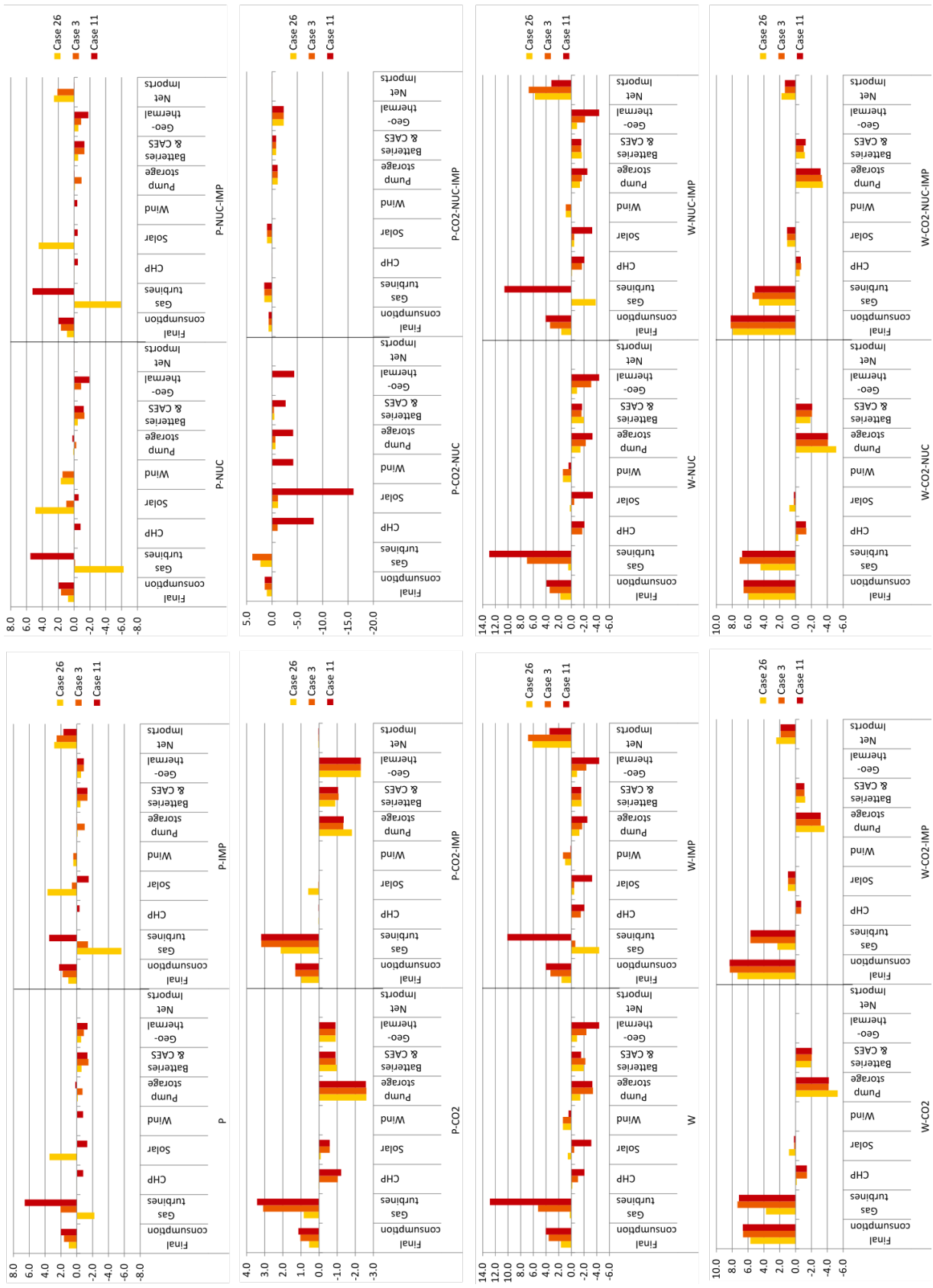

Figure 8.43: Changes in the final electricity consumption and generation mix in all scenarios between the grid restriction and grid expansion alternatives for the three different cases regarding the choices in location and size of large gas power plants, in 2050, in TWh

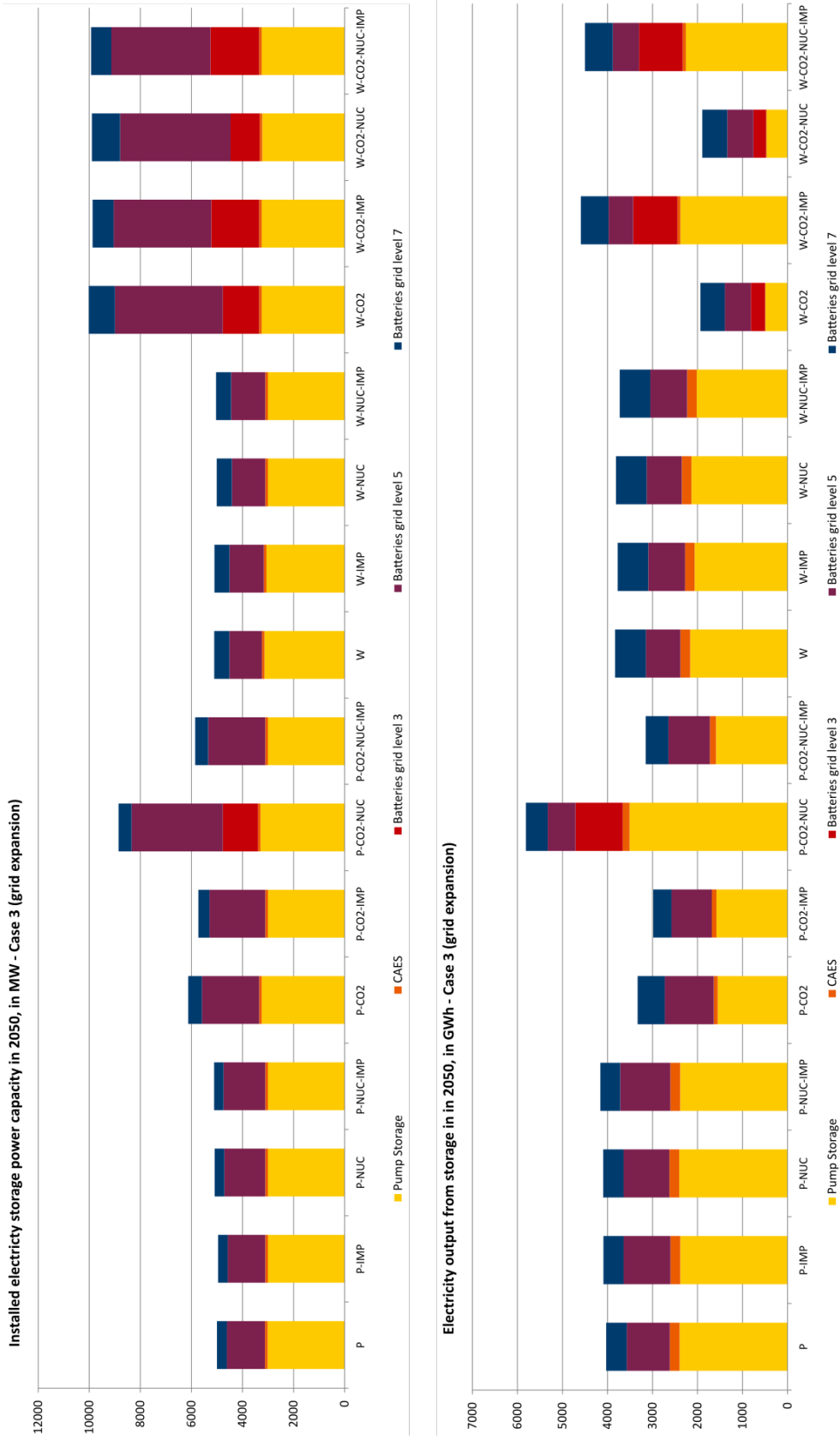

Figure 8.44: Installed electricity storage capacity and production in Case 3, under grid expansion, in 2050

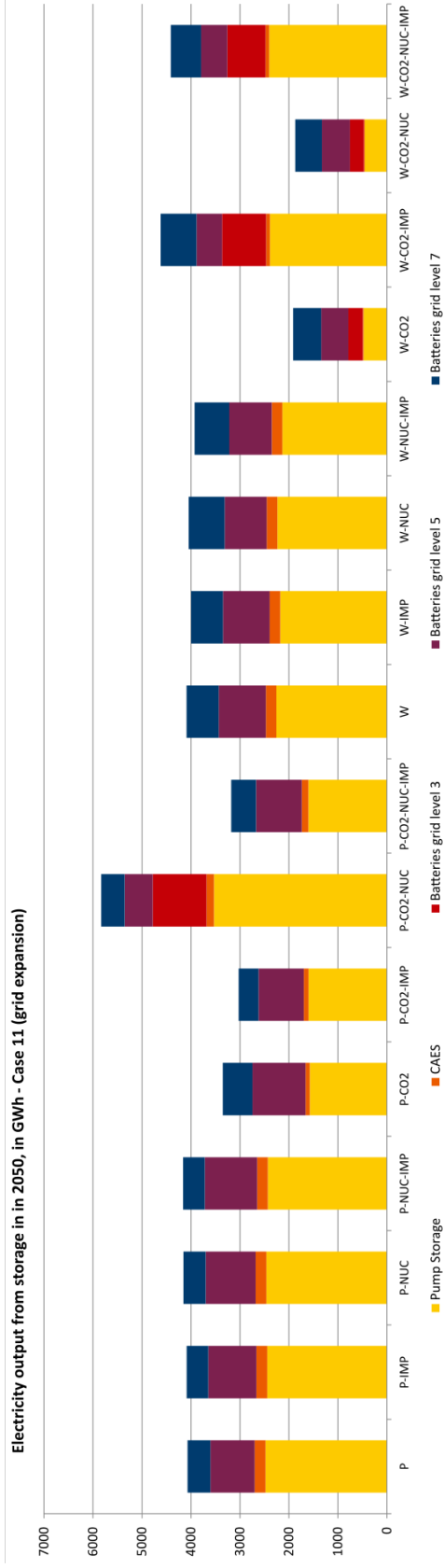
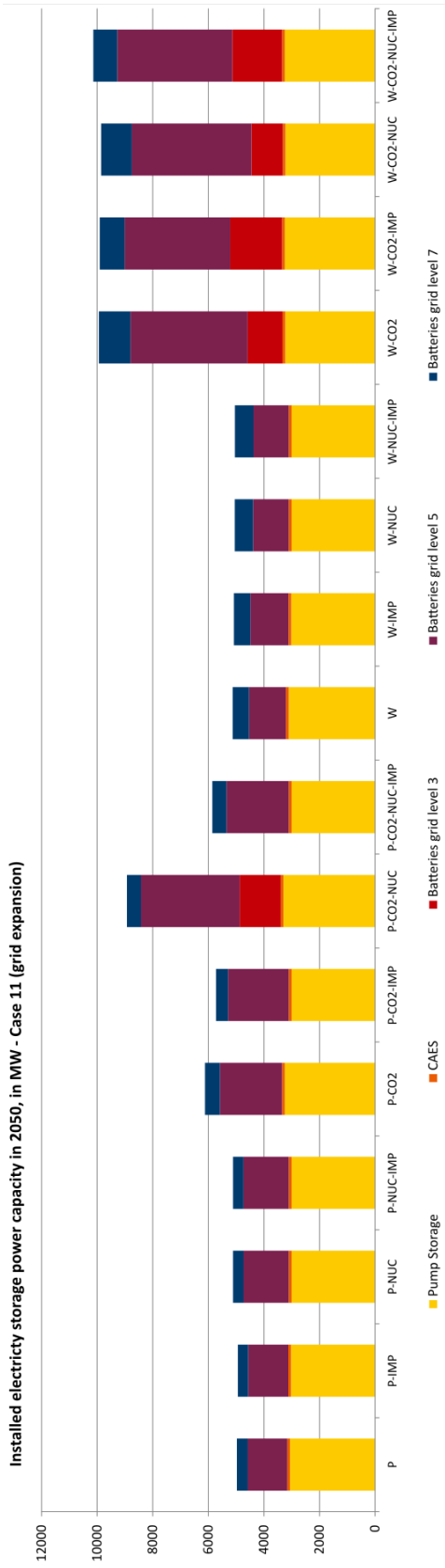

Figure 8.45: Installed electricity storage capacity and production in Case 11, under grid expansion, in 2050

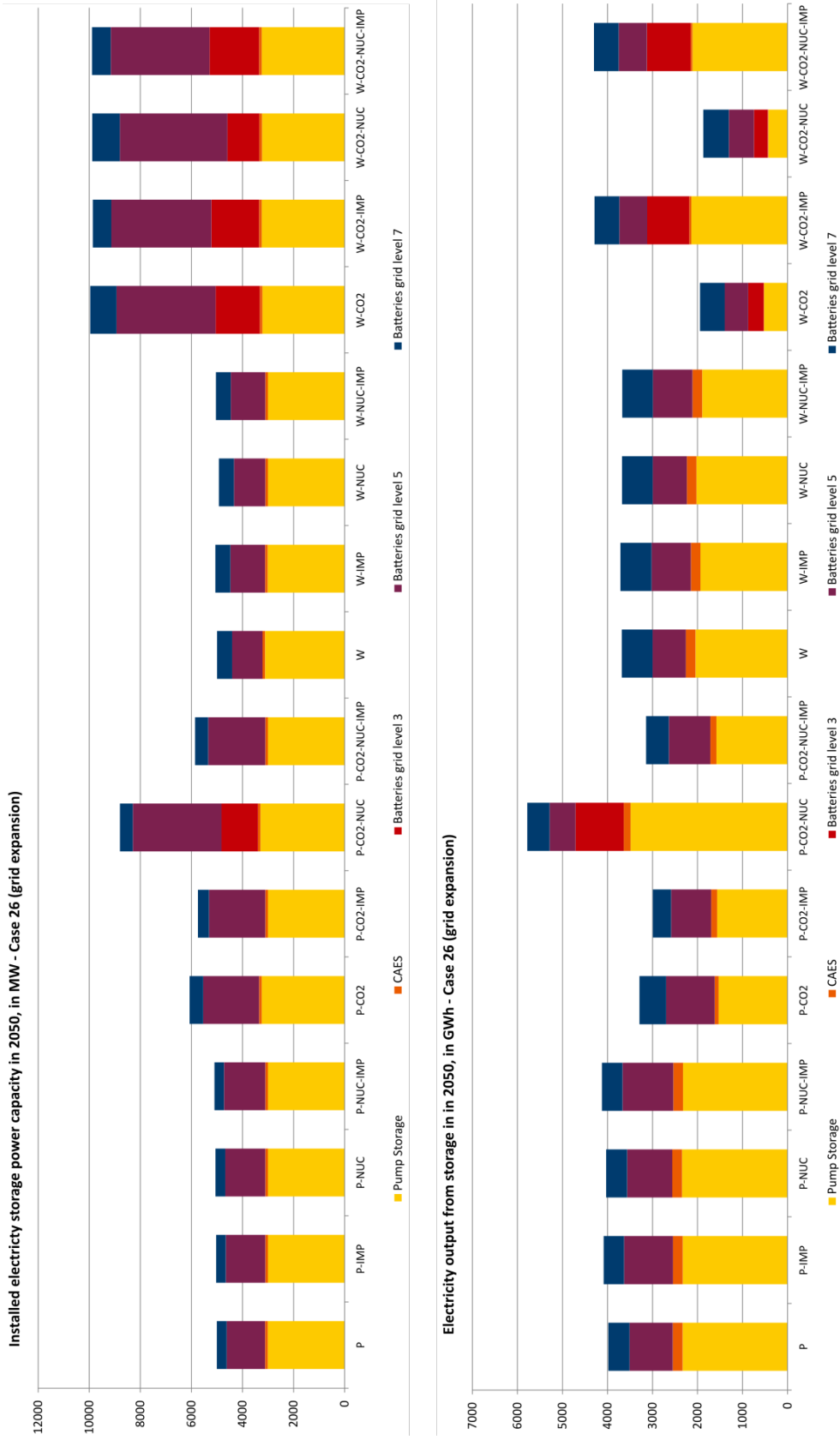

Figure 8.46: Installed electricity storage capacity and production in Case 26, under grid expansion, in 2050

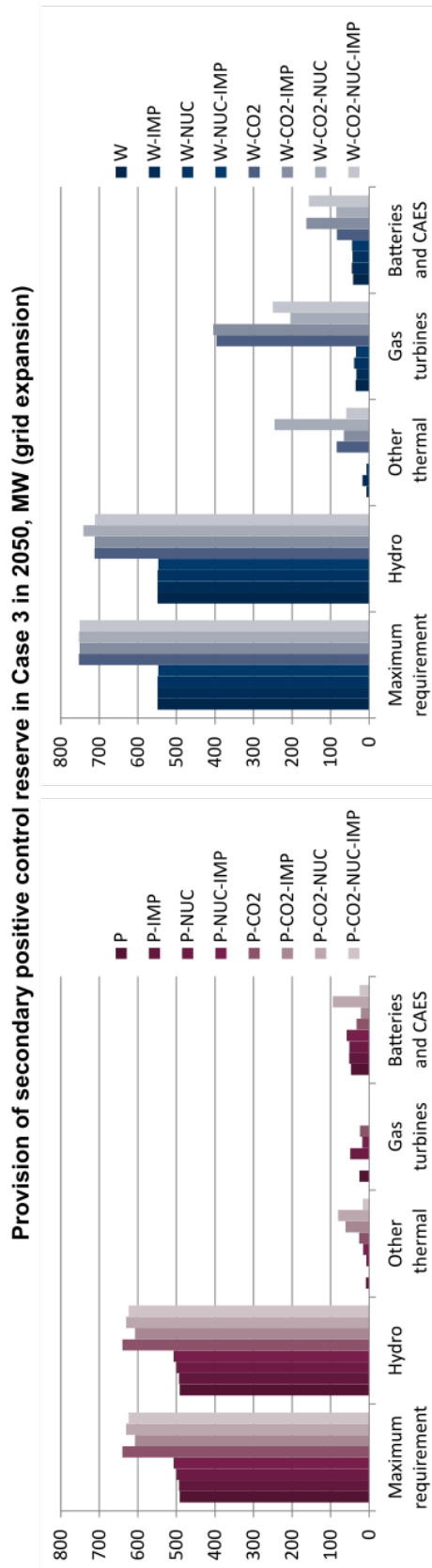

Figure 8.47: Maximum requirement in secondary positive control reserve and maximum contribution per technology in Case 3, under grid expansion, in 2050

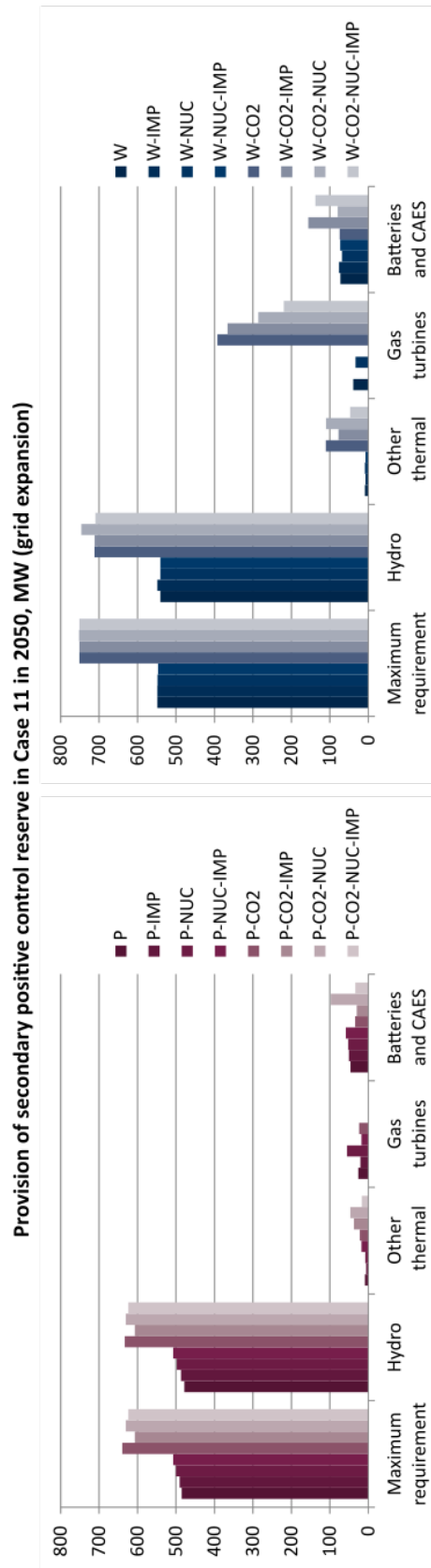

Figure 8.48: Maximum requirement in secondary positive control reserve and maximum contribution per technology in Case 11, under grid expansion, in 2050

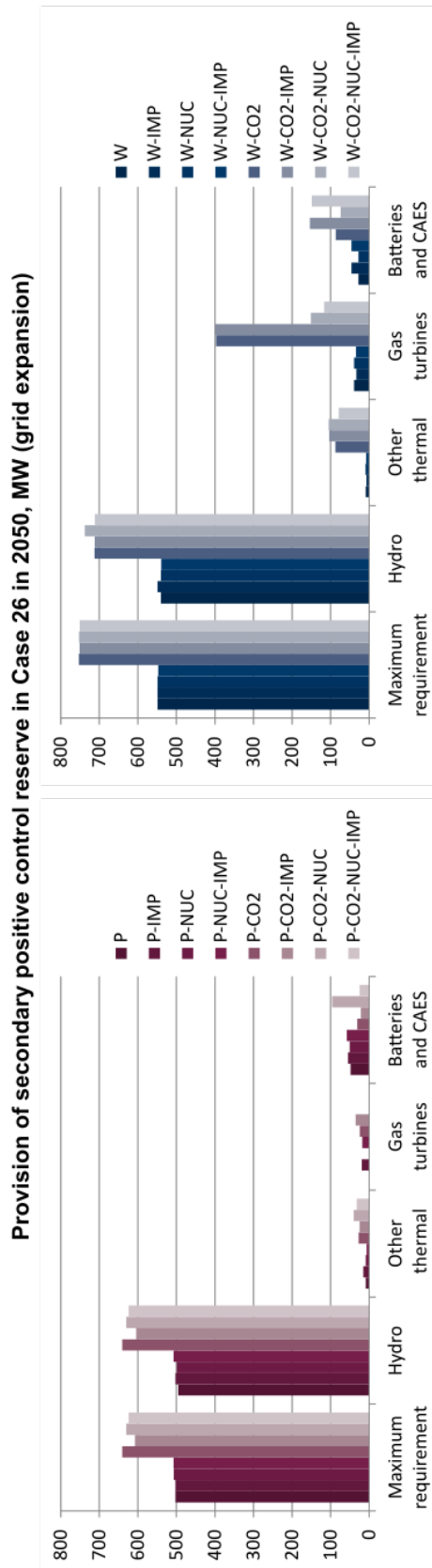

Figure 8.49: Maximum requirement in secondary positive control reserve and maximum contribution per technology in Case 26, under grid expansion, in 2050



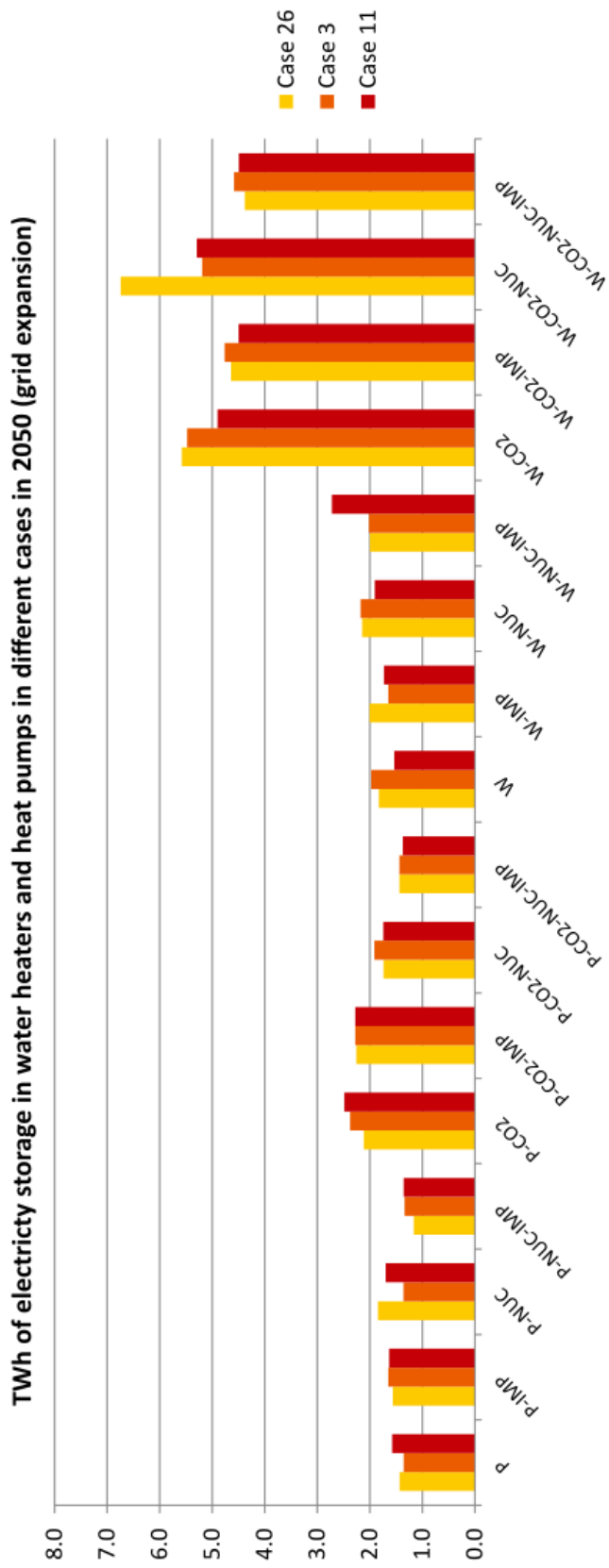

Figure 8.50: Electricity stored in water heaters and heat pumps in different cases, under grid expansion, in 2050

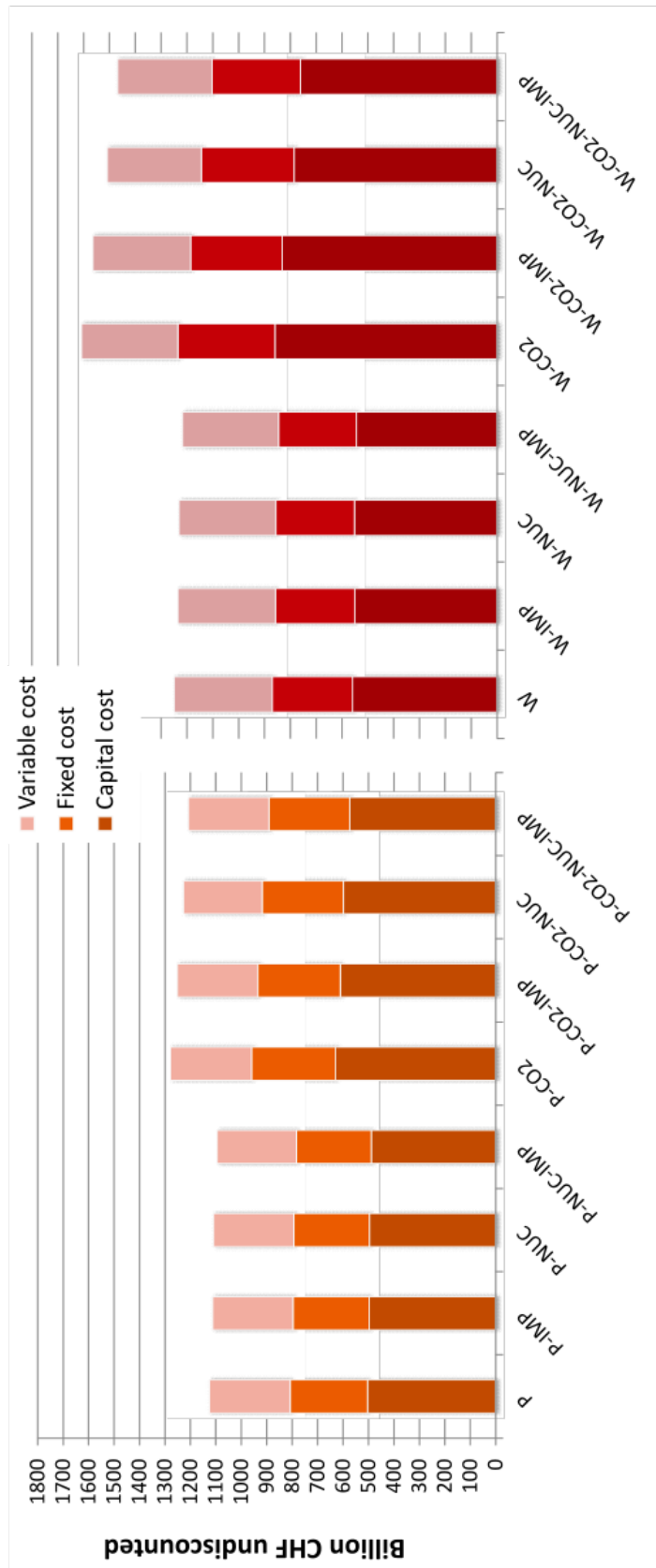

Figure 8.5.1: Cumulative undiscounted system cost over the period of 2010 – 2050 in Case 3, under grid expansion

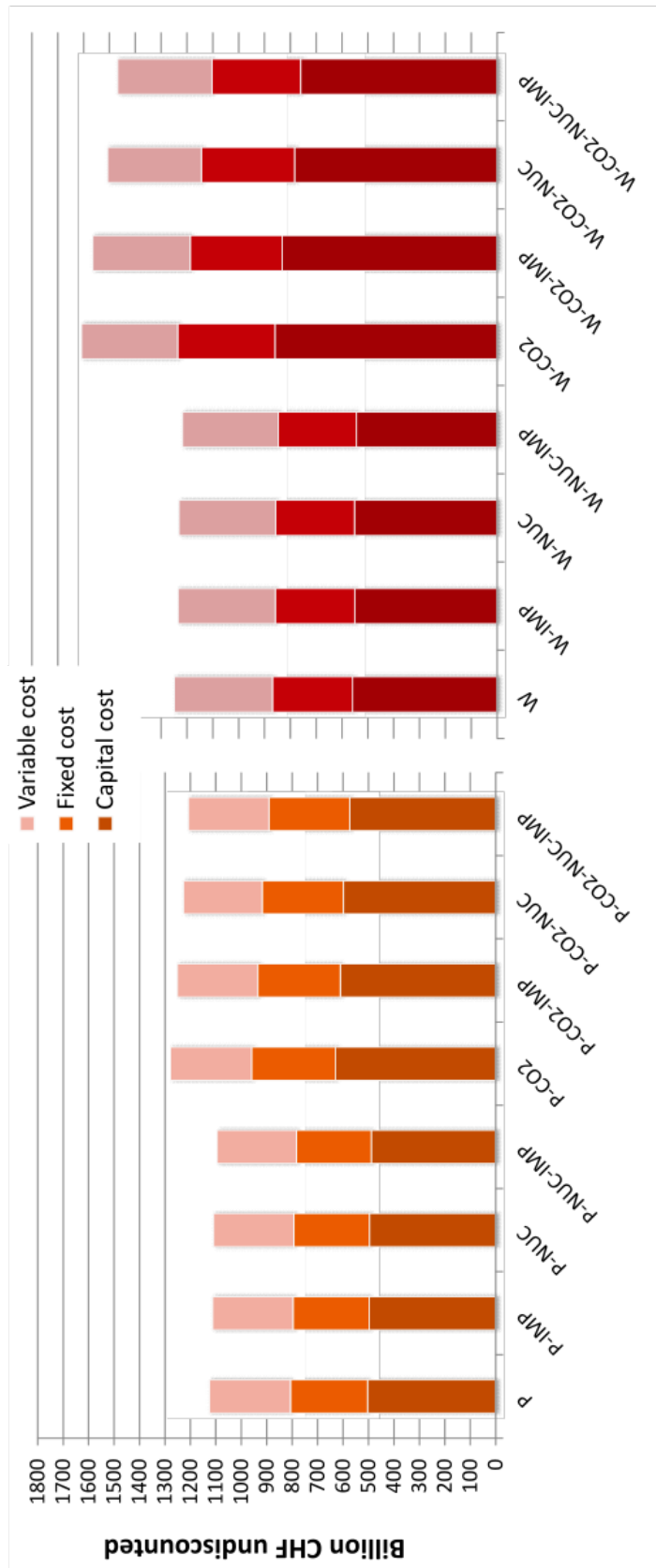

Figure 8.52: Cumulative undiscounted system cost over the period of 2010 – 2050 in Case 11, under grid expansion

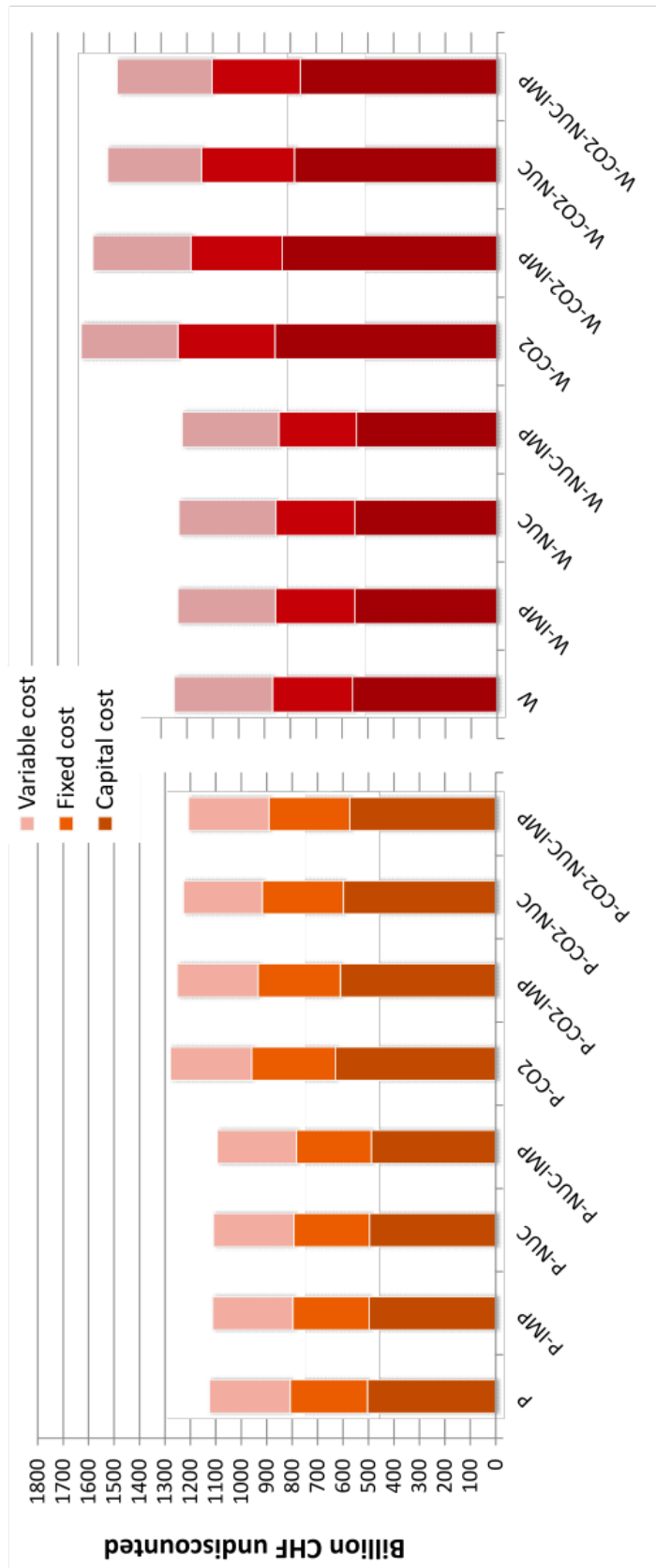

Figure 8.53: Cumulative undiscounted system cost over the period of 2010 – 2050 in Case 26, under grid expansion

## 9 Final Conclusions and Recommendations

This section summarizes the achievements, conclusions and recommendations of both the distribution and transmission grid study of this project.

1. *A software tool for the operation and planning of electricity grids* has been developed using a mathematical formulation of the technical power grid components, as well as the selected RES integration strategy.
2. *A time trajectory generator* of grid components for the current and future operation was developed to provide load profiles, cost profiles and PV profiles based on measurements and aggregated predictions. The tool is used for the grid planning and operation throughout the project.
3. The results of the quantitative RES integration study reached the following conclusions:
  - *Storage is only economical for higher electricity prices or lower storage costs than today.*  
For low demand scenarios, storage units are only economic for extremely low battery cost parameters. For high demand scenarios with little or no demand side management, storage units can become an economic approach that reduces the curtailment of the PV energy.
  - *Grid upgrade evaluation depends on the calculation costs of the grid operator.*  
The concrete costs of all network components were not evaluated. However, if the calculation cost of the grid component is known, for instance by the DSO evaluating the investment decision for the upgrade, the number can be compared to the potential gain from the reduced operating costs of the system.
  - *Economically, curtailment is in almost all scenarios reasonable to some extent.*  
The controllability of the PV components models the curtailment of available PV energy that would overload parts of the network. In the study, this approach served as a fallback option when the network became overloaded. The costs were not explicitly modeled but resulted from the opportunity costs of not injecting the available energy.
  - *Large potential of controllable loads.*  
A strong reduction of the system operating costs can be reached if parts of the nominal load demands can be shifted in time by the DSO. The benefit from such a DSM procedure is the reduced overall system costs. In a highly loaded and potentially congested network the reservation of even just 10% of the daily load demand to smart rescheduling creates a gain that would quickly offset any hardware investment costs. The difficulty lies rather in the operational procedures and interactions with the customers, that need to be altered.
  - Regarding Life Cycle Assessment, the environmental performance of components, e.g. batteries, depends on their application and operation parameters such as lifetime and efficiency. Data quality for the available inventory data is mixed. While for certain battery technologies (VRFB, future Li-Ion) as well as hydrogen and electricity generation data quality can be considered as high, inventory data for lead acid batteries and grid

- expansion/reinforcement are probably less accurate. Furthermore, a large variety of Li-Ion battery technologies exists, which could not be represented within the scope of this analysis. As a consequence, uncertainties related to some of the available LCA results are high. Due to time constraints, LCA could only be performed on the level of individual components of the electricity system, but not on the regional and national system levels. This limitation of the analysis needs to be addressed in further research.
4. An improved version of the electricity module of the STEM model has been developed. The foci are not only on the long-term capacity expansion planning but also on short-term electricity market operational decisions. It is suitable for assessing renewable energy integration strategies and includes:
    - a richer technology database regarding the characterization of the electricity storage option;
    - a representation of balancing services markets;
    - an enhanced representation of the temporal variability of electricity generation and supply
    - a representation of different electricity grid levels to which a range of power and storage options can be connected.
  5. A small reduced network model of the Swiss transmission network has been developed and used in the STEM planning simulations. The STEM model represents seven regions of Switzerland with distinct hydro generation, demand and nuclear generation variables as well as the interconnectors with the four neighboring countries. Based on the reduced electricity network developed in WP5, 638 grid elements (such as lines, transformers and busbar components) and 15 grid nodes were introduced into the STEM. The approach followed was to keep the current STEM structure and implement the grid constraints as an add-on, to avoid extensive data collection and model restructuring/recalibration in the case of a fully spatial representation of Switzerland.
  6. The results of the study highlight the need for being extremely careful when choosing the exogenously defined shares of electricity production technologies per region. The new version of the model is suitable to perform the scenario analysis in WP8 and to evaluate renewable integration strategies.
  7. The following scenarios and variants were assessed in the quantitative transmission grid RES integration study using the extended STEM model:
    - Two main alternatives were tested using no grid expansion and a grid expansion by doubling the capacity of the most congested line. The results show that the implementation of the Swiss Energy Strategy objectives, and in particular the integration of new renewables, could impose significant challenges to the transmission grid, which today is already congested in some areas.
    - If there were to be no further grid expansion other than planned for 2025, the congestion issues would exacerbate in the longer run. This is because of higher electricity

demand, but also by the choice of the location and size of new build large gas-based generation, which could potentially replace existing nuclear power. The inability of the transmission grid to integrate large gas power plants in some areas, enables investments in distributed generation, mainly solar PV, and geothermal (in those areas with good resources) as an option for base load electricity.

- If grid infrastructure restrictions are taken into consideration, long-term marginal costs of electricity supply are persistently higher than in the case where electricity grid issues are neglected in the STEM model. By interpreting this cost difference as congestion rent, in climate change policy scenarios congestion could occur even for about 7000 hours in a year in 2050.
- Batteries offer distributed (localized) balancing solutions with a deployment potential depending on the grid level to which they are connected. The uptake of battery storage is driven by solar PV (at low voltage levels), and wind and CHP (at medium voltage levels). At the same time, batteries complement pump-hydro (at high voltage levels), in particular when the latter is not available due to water availability.
- The high differences in seasonal electricity production costs under climate change mitigation policy and in the presence of grid congestion enable investments in Power-to-Gas technology as a seasonal storage option. CAES enters in the electricity sector as monthly storage with very region-specific deployment options (for instance in Ticino). We find that dispatchable loads at the end-use sectors (such as water heaters and heat pumps) contribute to ease the congestion to some extent.
- Limitations in the electricity grid expansion infrastructure can impose high costs for the electricity sector, which can be up to 3 billion CHF per year on average.
- During electricity grid expansion, the net economic benefits can outweigh the cost. In this case, neither location nor size of large gas power plants is an issue for congestion.
- Electricity storage is important for the integration of variable renewable energy sources for electricity generation and the reduction of CO<sub>2</sub> emissions.

The analysis provides enriched insights related to the integration of renewable energy technologies in Swiss electricity and heating system and their related grid issues. In overall, the methodology developed in the ISCHESS project for integrating electricity grid constraints in the STEM model is a significant advancement in Swiss energy systems models. The methodology developed and applied in this project goes beyond “conventional” energy systems modelling, where the electricity grid is often neglected and the electricity transport system represented as a copper plate. Thus, the coupled framework of STEM with the detailed electricity transmission network model of FEN has been proven to deliver a suitable framework for considering network aspects in energy modelling for Switzerland allowing for more distinct analysis of energy technology development and energy policy.