

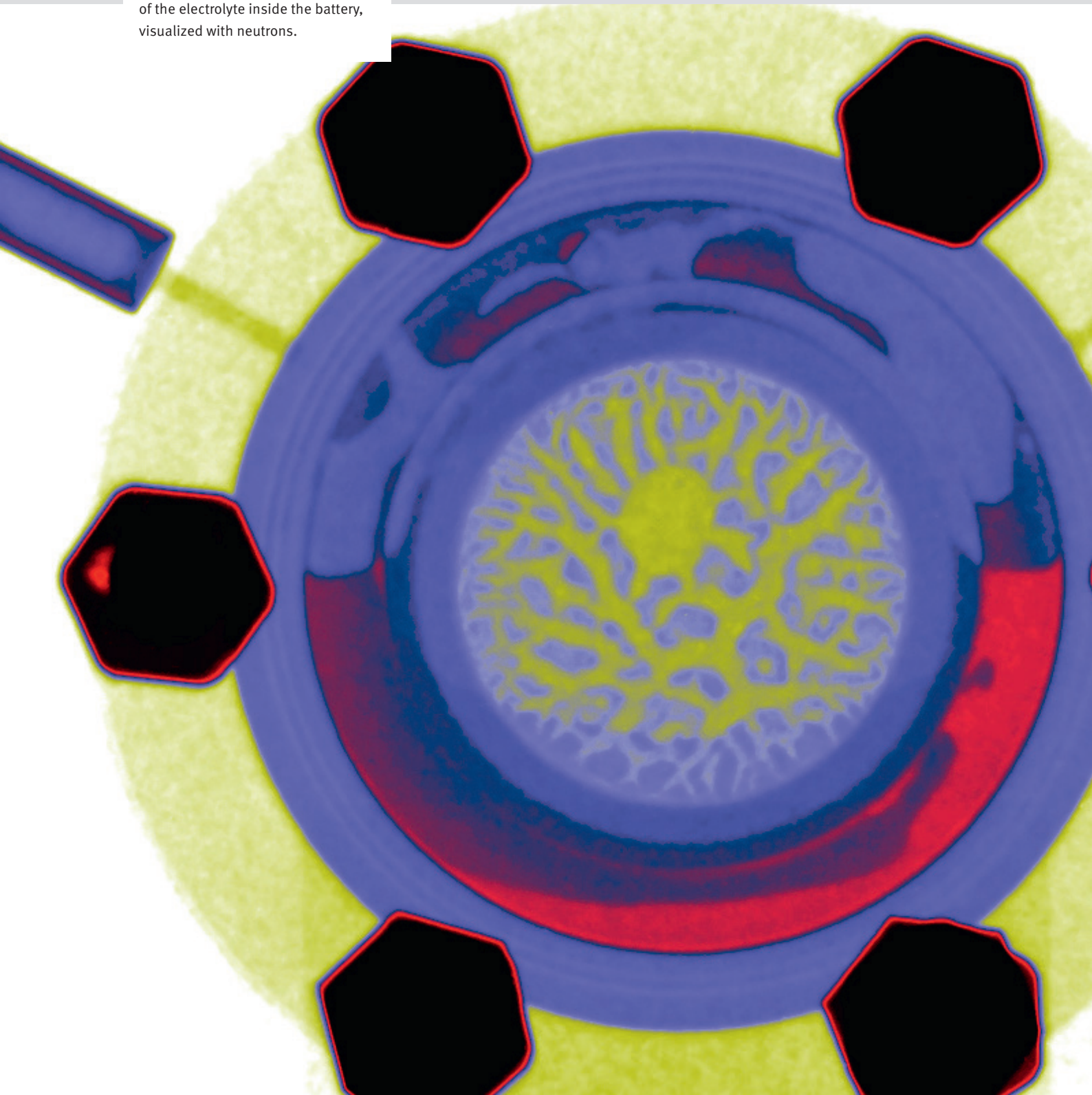

Neutron imaging at the spallation source SINQ

Information for potential users and customers

Battery research: distribution of the electrolyte inside the battery, visualized with neutrons.



Contents

4	Neutron imaging
4	Introduction
6	Nondestructive testing
7	Neutron transmission
10	Facilities
10	SINQ
12	NEUTRA overview
14	ICON overview
16	NEUTRA
17	ICON
18	Detectors and methods
18	Principle of measurements
19	Neutron microscope
20	Detectors
22	Tomography
23	Time dependent neutron radio- and tomography
24	Energy-selective imaging
25	Phase contrast and dark-field microscopy with neutrons
27	Scientific use
31	Industrial applications
34	Outlook
34	Neutron imaging with polarized neutrons
35	PSI in brief
31	Imprint
31	Contacts

Cover photo

Placing a plant sample for radiographic inspection at the cold neutron imaging facility ICON. Neutron imaging shows humidity transport from soil into roots (see page 28).

Neutron imaging

Introduction

This booklet presents information about “neutron imaging”, or as it is usually referred to, neutron radiography. Neutron radiography is in use at Paul Scherrer institute since 1997 and is still in further development, particularly with regard to new measurement methods and applications.

The following pages present information generally understandable by a broad audience, but targeted to potential users too. Fundamentals about neutron sources, area neutron detectors and the different measurement methods are explained. Selected results demonstrate the usefulness of

neutron imaging for a wide range of applications.

Neutrons are – as their partners the protons– the building blocks of the atoms, of which matter is made. Free neutrons are produced solely by nuclear reactions. Besides their use for energy production in nuclear reactors, they are essential probes for materials research on atomic and molecular length scales. However they also can be used, like ordinary medical X-rays, for radiography purposes on macro-

scopic samples. In this booklet we concentrate on these latter, macroscopic, neutron imaging applications. For neutron imaging, strong neutron sources are required in order to guarantee high quality radiography image. Paul Scherrer Institute operated for many years the research nuclear reactor SAPHIR (commissioned 1957), which was replaced by the spallation neutron source SINQ in 1997.

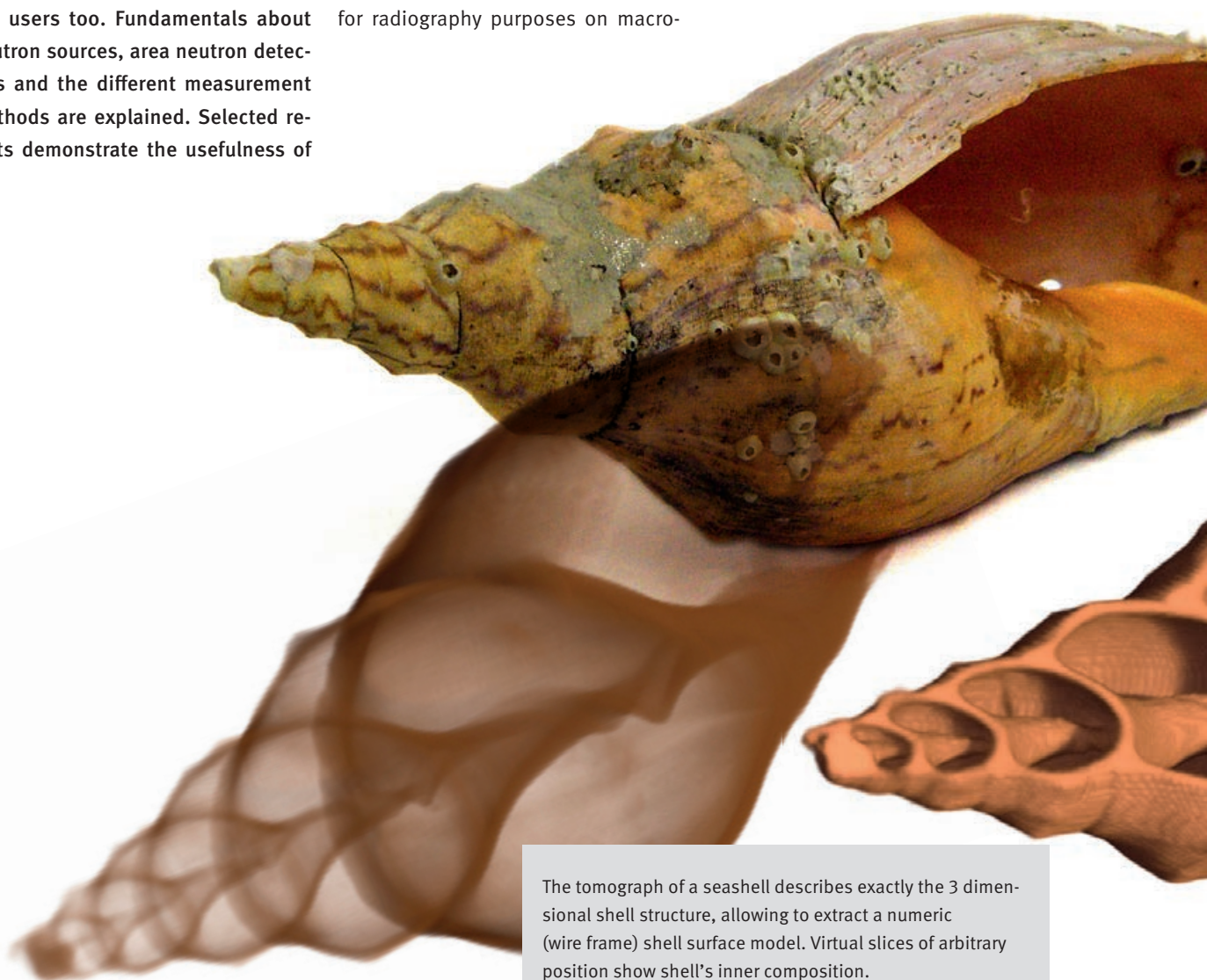

The tomograph of a seashell describes exactly the 3 dimensional shell structure, allowing to extract a numeric (wire frame) shell surface model. Virtual slices of arbitrary position show shell's inner composition.

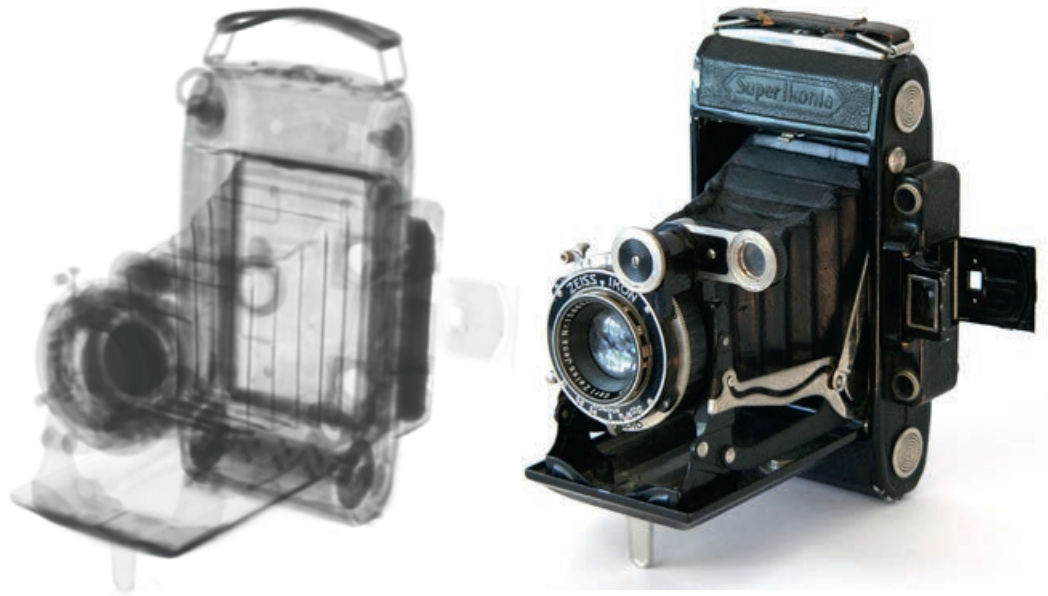

Because high intensity neutron sources are not transportable, all neutron imaging investigations have to be performed on the site of the neutron

source. The PSI spallation neutron source is driven by the large PSI proton accelerator facility. Complementary to the neutron source, a large infrastructure allows investigating selected samples, monitoring transport processes, or detecting structural material changes.

Photograph (right) and transparent neutron tomograph (left) of an old camera. With neutron tomography the inner structure of the camera is unveiled. Camera components can be virtually extracted.

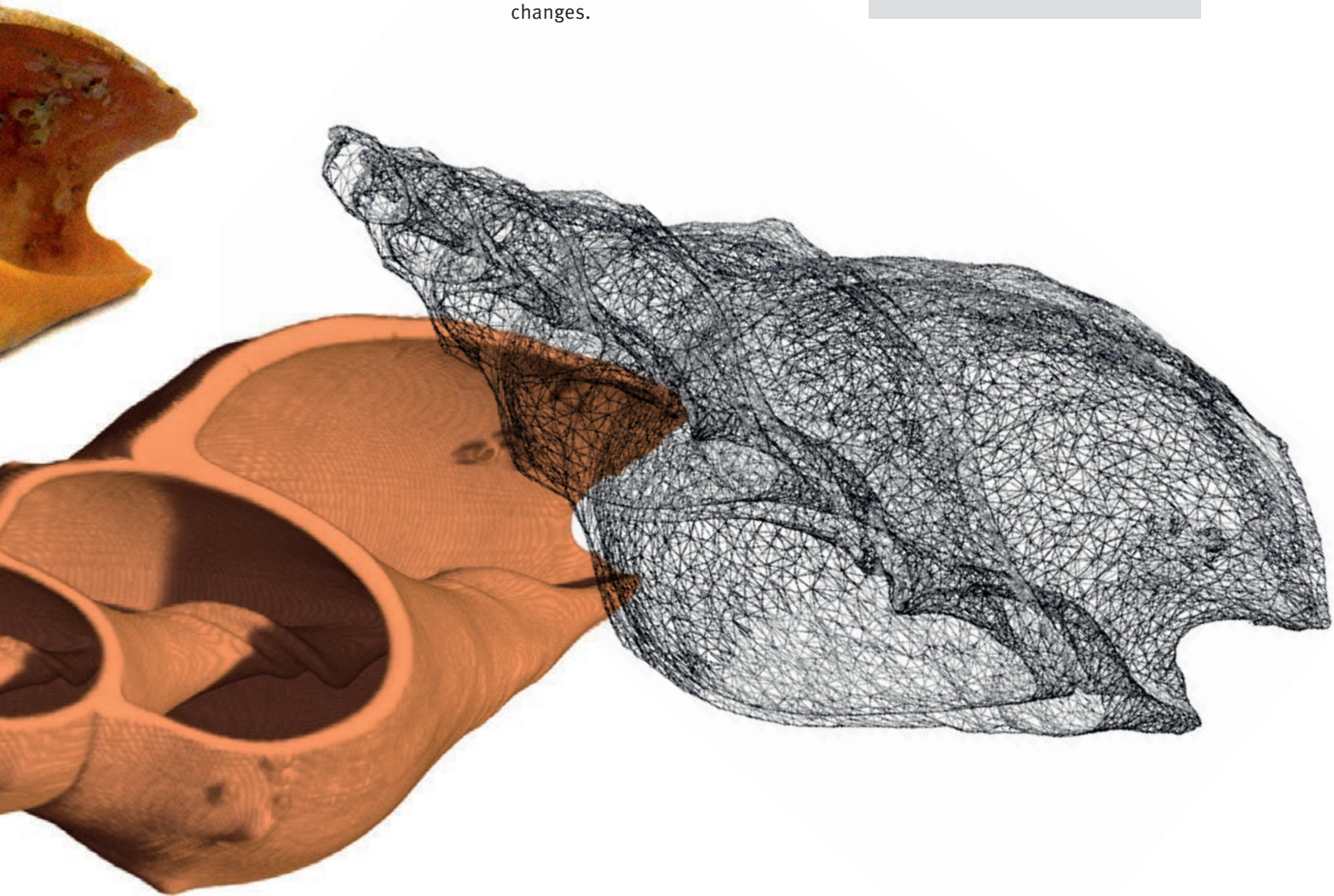

Nondestructive testing

Neutron radiograph of a steel lock, showing individual metallic components.

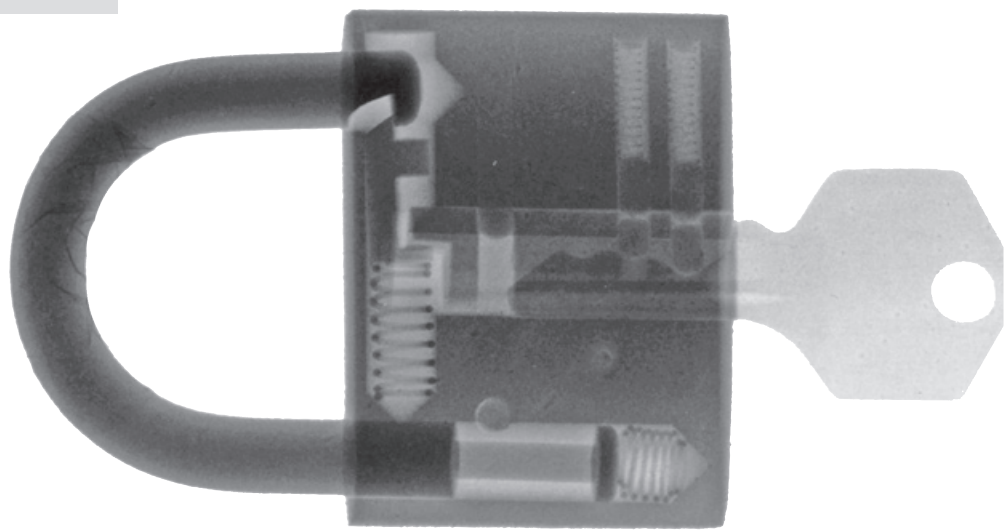

Rendering an object transparent in order to directly detect cracks, hidden inner flaws or structural material changes is an engineer's dream. Visible light, because reflected from or absorbed by the surface of most materials (except e.g. glass, water...), leaves us only with an opaque view of the object's outer surface. Nondestructive radiography technologies are used to detect material faults inaccessible to direct observation.

Nondestructive testing (NDT) methods are required if the functional capability has to be verified without object disassembly and/or if the sample integrity should not be affected by the investigation. Such methods are quite often mandatory, to guarantee the safe op-

eration of a system or to check highly expensive or unique samples. NDT methods are therefore frequently applied in the aerospace and automobile industries or in investigations of cultural artefacts.

Partial or full object transparency can be provided by various physical modalities like X-ray, ultrasound, microwave, infrared radiation, etc. Since the discovery by Conrad Roentgen, X-ray is probably the best known radiation modality due to its widespread use in medicine and in industrial-scientific applications. The characteristics of the X-rays, i.e. wavelength and intensity, are chosen according to sample composition and the aim of the investigation.

Like X-rays, neutrons penetrate matter. The Figure above shows the neutron

radiography of a lock. Material composition and thickness yield different image contrasts, illuminating the individual components of the lock and detecting component flaws or possible assembly errors. Neutron imaging provides a complement to conventional X-ray investigations. Specific differences between the modalities are discussed on page 9 of this brochure.

Neutron transmission

Neutrons act as probes for nondestructive testing because they can penetrate thick-walled samples. Due to the interactions of neutrons with matter, they provide an image of transmitted radiation i.e. a neutron radiograph. Since X-rays interact differently with matter, the two radiation modalities highlight complementary properties of an object's internal structure. A powerful neutron imaging facility requires a strong neutron source. The neutron beam should be well collimated and, to insure radiation safety, strongly shielded. For imaging purposes, neutrons are detected nowadays mainly using special area detectors, which provide digital images of high sensitivity and spatial resolution. Previously, X-ray films were used for this. Paul Scherrer Institut offers two state-of-the-art neutron imaging facilities, NEUTRA and ICON for thermal and cold neutron radiography, respectively. Several experimental techniques are available for investigations in a wide range of scientific and industrial applications.

Neutron radiography

A radiograph is an image produced by radiation which passes through an object. Radiography is commonly known as the technique, providing radiographs on films or digital detectors, which relies on radiation transmission measurements. Medical X-ray is the application familiar to most people, due to its frequent use by physicians or dentists. In the hospital, X-ray computer tomography (CT), the three di-

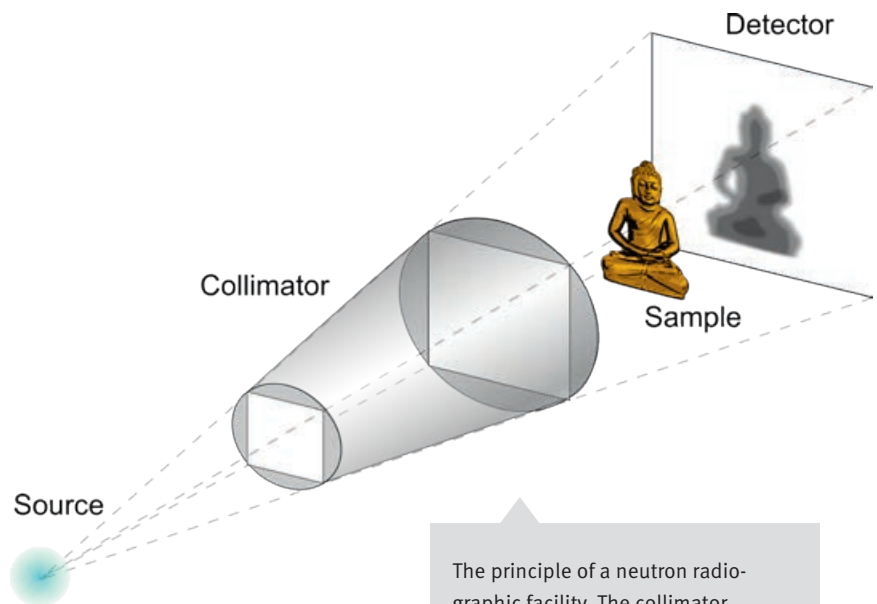

mensional variant known for several decades, provides volumetric information about inner organs, bone fractures, cancer, ... More and more, X-ray applications spread into other scientific and technical fields, where they are tuned to special requirements, e.g. sub-micrometer resolution in synchrotron micro-tomography. Similarly, the use of ultrasound or nuclear magnetic resonance techniques in science and industry is spreading. Neutron radiography however, although known a long time, is not yet widely used for nondestructive testing, because it is available only at a few places. Its complementarity to X-ray makes it an essential tool for NDT evaluations in cases for which ordinary X-ray fails e.g. transmission through heavy metal samples or detection of small amounts of hydrogen within a metallic base material. The principles of neutron and X-ray radiography measurements are the same, except for the different sources and interactions with matter of the radiation (see page 9).

The principle of a radiograph facility is shown in figure above. Neutrons are guided from the radiation source

The principle of a neutron radiographic facility. The collimator selects a straight neutron beam. A neutron area detector behind the object measures the transmitted beam.

through an evacuated flight tube, the collimator, to the object. The neutron detector behind the sample first converts the transmitted radiation into another physical quantity, e.g. light, which is then measured and recorded digitally. Each area detector element records the intensity of the neutron transmission in a pixel, an element of the image plane. The spatially varying neutron transmission through the object is thereby mapped into a plane radiography i.e. projection image. For tomographic neutron imaging, the sample has to be rotated in small angular steps around 180°. Images of plane sections, perpendicular to the objects rotation axis, can then be mathematically reconstructed from all projections and merged as a stack of slice images. Thus a volumetric, tomographic representation of its neutron attenuation characteristics is generated (see page 22).

In reality a neutron imaging facility is more complex than sketched in figure on page 7. As mentioned above, a strong neutron source is an important prerequisite for high quality neutron imaging. For every radiation source, there are legal requirements regarding the safe operation and radiation protection of the personnel. A neutron imaging facility is therefore located within a measuring room, constructed of thick concrete shielding walls, and accessible only through a labyrinth secured by a safety door (see pages 12 and 14).

Properties of the neutron...

- Neutrons are neutral particles (i.e. particles without electric charge). Together with the positively charged protons, they are the building blocks of the atomic nucleus.
- The mass of the neutron is $1.675 \cdot 10^{-27}$ kg or 939.57 MeV/ c^2 . (c representing the speed of light, MeV is a physical energy unit. The two values relate to each other by Einstein's famous formula $E = mc^2$).
- A free neutron is not stable, it is a radioactive particle. It decays after a mean lifetime of about 15 minutes into a proton, simultaneously emitting an electron and an anti-neutrino.

- The interaction of a free neutron with atoms is not influenced by their electron cloud. Therefore it can penetrate deeply into matter. The neutron reacts with the atomic nucleus in a manner which varies greatly with isotopic composition and neutron energy. Some atomic nuclei, e.g. boron, lithium, cadmium, gadolinium, capture neutrons incident at low speed. This interaction process is termed neutron absorption. Materials containing such elements are well suited as shielding materials or for neutron detection. Other atomic nuclei, e.g. aluminium or lead, interact only weakly with neutrons; they are almost transparent for neutrons. Some nuclei induce rather a deviation of the neutron from a straight trajectory, producing neutron scattering reactions. Occurring in most isotopes, they are especially strong in hydrogenous materials.
- Like other elementary particles, neutrons act not only like massive particles but also like waves. The wave propagation formalism using the same laws of optics as applied to light (see phase contrast on page 25 and 26), i.e. an index of refraction showing the effects of diffraction or interference, accurately describes some neutron interactions with matter.

- After their creation by fission or spallation reactions, free neutrons propagate at high speed. Their slowing down, termed neutron moderation, is determined by inelastic scattering processes with light elements e.g. hydrogen or deuterium in the moderator tank. For materials research, thermal or cold neutrons are of special relevance because their energy or wavelength is appropriate to elucidate the structure and dynamics of solid-state or soft matter. The dependence of the interaction probability of neutrons with matter on energy or wavelength can be used to produce variable image contrast in neutron radiography applications. Neutron detection reactions yield high probabilities at low neutron energies, a prerequisite for sufficient sensitivity and spatial resolution in neutron imaging.

... and differences with X-ray

Differing essentially from neutron radiation as described above, X-ray radiation is electromagnetic radiation which interacts with the electrons in the atomic shell of a nucleus. The atomic interaction probability correlates strongly with the number of electrons of an element, i.e. the atomic number Z . Heavy materials induce strong X-ray attenuation, whereas light materials, like e.g. tissue, water, plastics ... attenuate weakly. No such Z dependence exists for thermal or cold neutron matter interaction. X-ray absorption (pho-

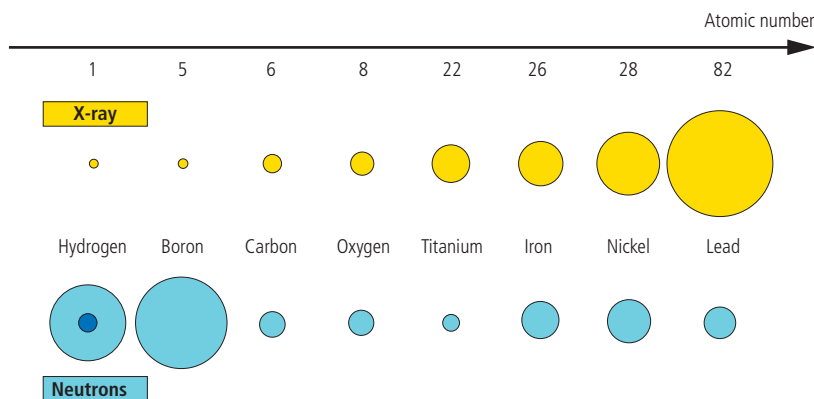

Comparison of X-ray and thermal neutron interaction probabilities for selected elements.

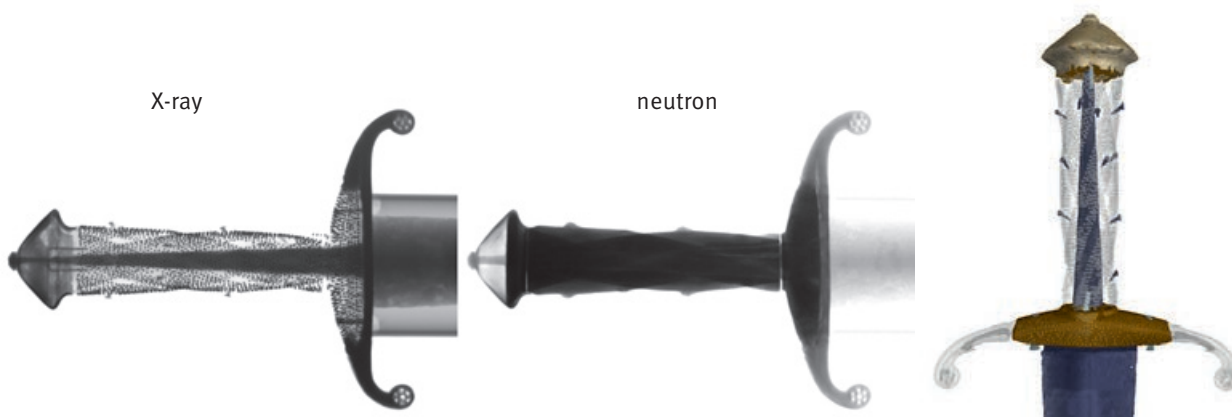

Transmission radiographs (left) and tomographic reconstruction (right) of a wooden sword grip originating from the middle age. The combination of neutron- and X-ray tomography reveals the inner shape of wooden parts and the rich metallic decoration.



Transmission radiographs (left) and tomographic view (right) made from a Swiss-army knife.

Plastic parts are transparent, whereas steel blades show strong contrast in X-ray. Neutron attenuation shows shape of plastic parts and lubricating oil.

toelectric effect) is the dominant reaction at low photon energies, whereas X-ray scattering (Rayleigh-scattering and Compton-effect) prevails at higher energies. Figure on page 8 depicts the differing interaction probabilities of radiation with matter for X-ray (yellow) and thermal neutrons (blue) for a range of materials from low Z (hydrogen) to high Z (lead). The size of the circles indicates increasing interaction probability. The figure suggests that lead is an efficient shielding material for X-ray radiation, but not for neutrons, for which lead is almost transparent. We

illustrate the complementary attenuation characteristics of X-ray and neutrons on two samples, a wooden grip of a sword from the middle ages and a Swiss army knife. The investigation of cultural heritage objects requires non-destructive testing methods to learn about the inner structure and possible manufacturing techniques. X-ray imaging is nowadays applied regularly whereas neutron imaging only in special cases. The combination of both modalities provides 3D volume information showing the complimentary contrast information. In the case of the

wooden grip, X-ray shows nicely the rich decoration made of small tin amalgam inserts, whereas neutron imaging shows the various wooden parts and their shapes.

Facilities

SINQ

Bird's eye view of the spallation neutron source SINQ. The vertical proton beam impinges from below on the heavily shielded target block in the middle. Neutron beams are extracted horizontally to several instruments. The green area in the middle cover the NEUTRA imaging facility.





To be used for neutron scattering or imaging, neutrons must be set free from the atomic nucleus. This can be achieved by nuclear reactions inducing fission or other types of nuclear transformation. The nucleus, or its fragments, reach thereby excited states, which de-excite by emission of secondary particles e.g. neutrons and photons.

Nuclear fission and spallation are the two most important nuclear processes producing free neutrons. Nuclear fission is induced by the collision of thermal or fast neutrons with a neutron-rich, fissionable, heavy nucleus like uranium-235. There result, two radioactive, fission-product nuclei and 2–3 free neutrons. Under favourable conditions, one of the emitted free neutrons induces another fission reaction and sustains a chain reaction. This process drives nuclear reactors used for energy production or provides a neutron source for materials research. Most neutrons used for research purposes worldwide are generated by nuclear fission.

Nuclear spallation is induced by directing highly energetic charged particles, e.g. protons, onto metallic target nuclei. The charged particles, produced by a particle accelerator at energies of several hundred MeV, collide with individual nucleons (i.e. neutrons or protons) of the target nucleus, which then

are ejected or experience further collisions (intra nuclear cascade). This process yields a highly excited residual nucleus, which de-excites by releasing further neutrons or protons (see figure below). Below energies of 15 MeV, no further nucleons are ejected and the residual is called a “spallation product” nucleus. This whole process, known as spallation reaction, may release 10–15 neutrons per incoming charged particle.

A spallation neutron source requires a powerful proton accelerator facility. The protons are confined and guided by magnets within evacuated tubes to the heavily shielded spallation neutron source (shown on page 10). The advantages of using a spallation source rather than a nuclear fission reactor are the much fewer nuclear safety concerns: no fissile material is needed, no chain reaction needs to be controlled, and less radioactive waste results. Neutrons generated either in a fission reactor or a spallation source are too energetic to be useful and must be slowed down by scattering processes to thermal energies (~2200m/s) in a moderating medium, e.g. a heavy water tank. Cold neutrons are produced by scattering thermal neutrons on cold molecules e.g. liquid heavy hydrogen at -250 °C.

The spallation neutron source SINQ of Paul Scherrer Institute has been in operation since 1996 (see figure page 10). This brochure gives an overview of the two neutron imaging facilities NEUTRA (thermal neutrons) and ICON (cold neutrons), explaining available experimental methods and presenting selected neutron imaging applications.

Neutrons produced by spallation: high energy protons hit a heavy atomic nucleus (e.g. lead). The protons eject nucleons from the target nucleus, leaving a highly excited residual, which yields further nucleons.

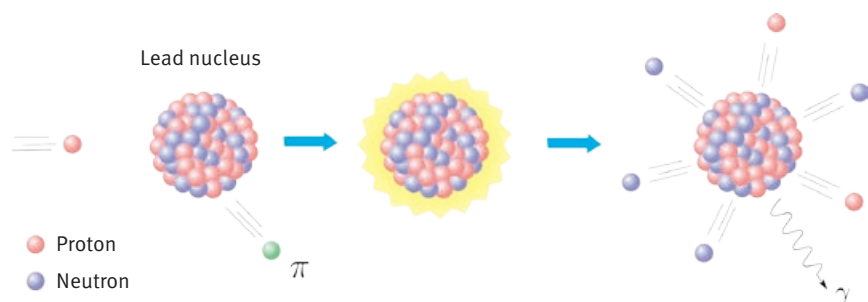

NEUTRA overview

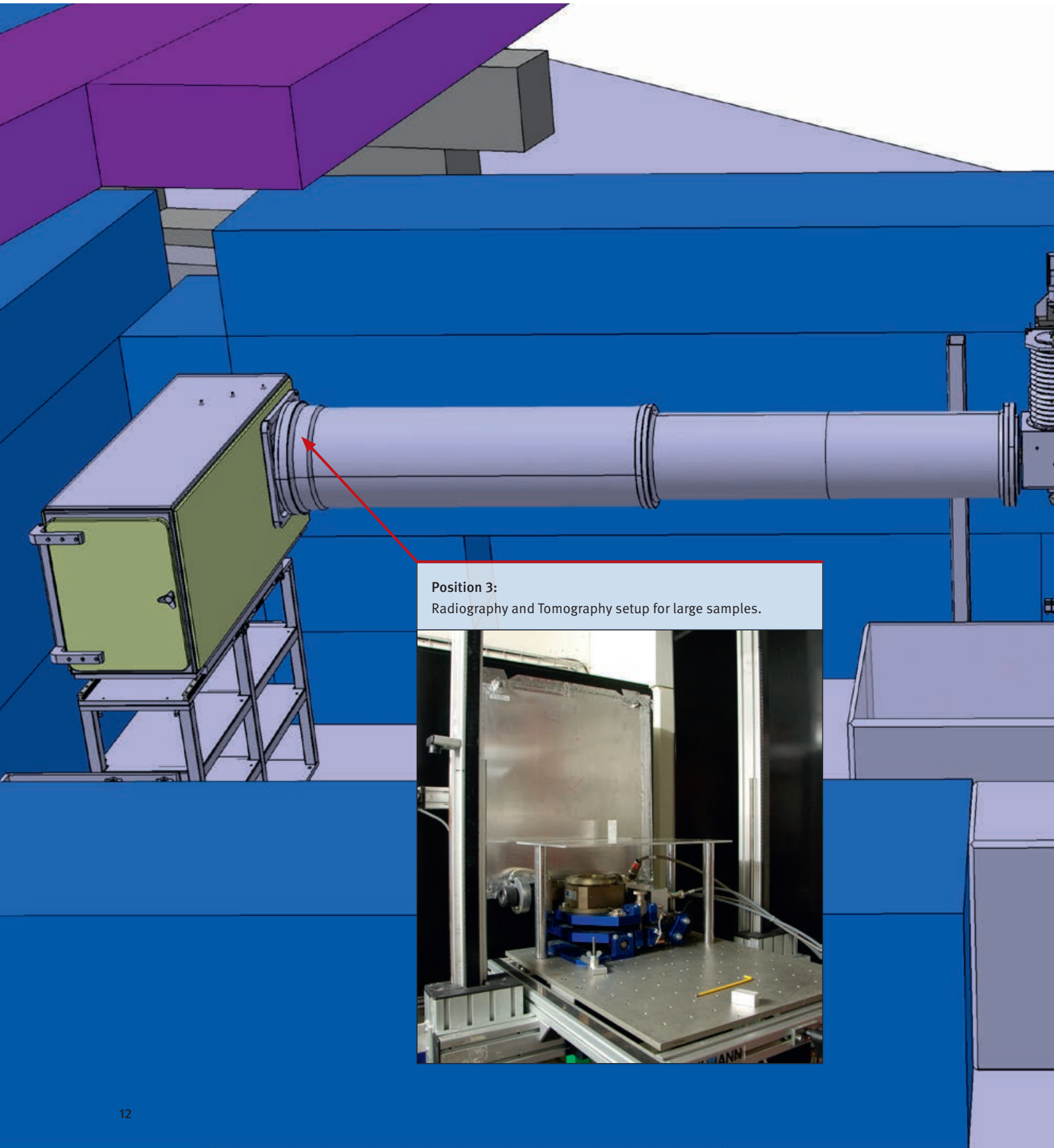

Position 3:
Radiography and Tomography setup for large samples.

Optional use of a
320 kV X-ray tube.



Position 2:
Combined neutron- and X-ray tomography investigations of small objects.



ICON overview

Position 3:

Large and heavy objects, scanning.
Macro-Tomography.

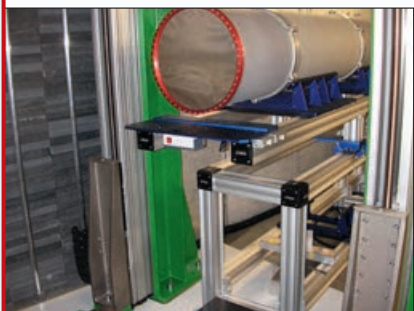

Exit of flight tube, scintillation screen.

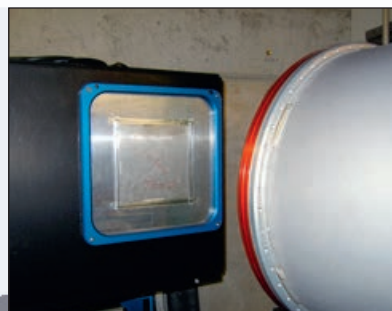

Secondary detector at position 2 for
X-ray and neutron diffraction imaging.

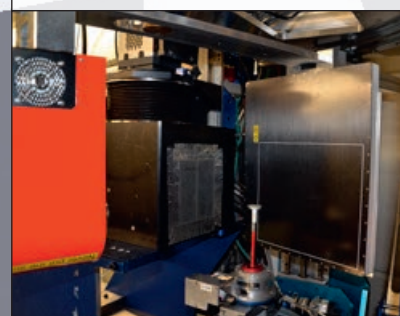

Position 1:

Fail safe and experiment neutron shutter.

Options:

Evacuated flight tube

Neutron velocity selector

Time of flight chopper

Beryllium filter

Source grating for neutron interferometry

Position 2:

Small objects

Micro tomography, scanning

Grating interferometry,

neutron microscope.

Neutron aperture
selection drum.

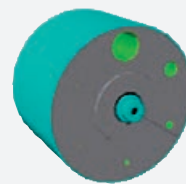

NEUTRA

NEUTRA, the thermal neutron radiographic facility, contains a convergent inner collimator tube section, guiding neutrons to a fixed size aperture 2cm in diameter. From there, a divergent collimator section opens to a useful area of 15cm diameter at the beam exit (measuring position 1) – 29cm at position 2, and 40 cm at position 3. This permits neutron imaging of samples with dimensions ranging from a few cm to a maximum of 30 cm. Both radiography or neutron tomography experiments can be set up at the two measuring positions. The investigation of highly radioactive samples is made possible by a special setup, **NEURAP**.

In addition, an X-ray tube may be positioned in the neutron beam path at position 1, thereby providing almost identical imaging geometry for neutrons and X-rays, **XTRA**. Thus the complementarity of X-ray and neutron attenuation may be fully exploited. Highly radioactive objects are strong γ -sources, making nondestructive imaging by X-ray transmission impossible. However neutrons can be used for this purpose, if a special detector, sensitive only to neutrons, is employed. Moreover, neutrons pass easily through the heavy metal components of nuclear power plants or neutron spallation sources. For radiation safety reasons, these samples must be transported and manipulated using shielding containers and remotely controlled equipment. The NEURAP setup, shown in the figures, permits positioning such samples in the neutron beam. Consisting of a heavily shielded steel cask with a built-in aluminium transport container which

can be lowered into the radiography facility, it can be rotated about its vertical axis for tomography. Some results of investigation can be seen in the figure on page 30 (in the middle).

NEURAP transport/manipulation cask for highly radioactive samples.

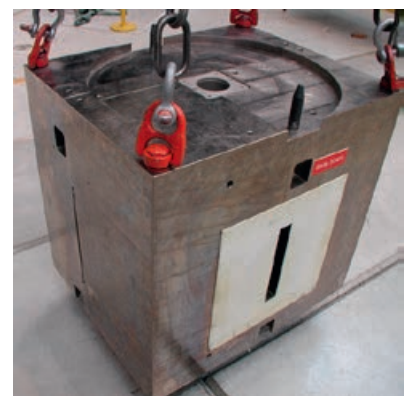
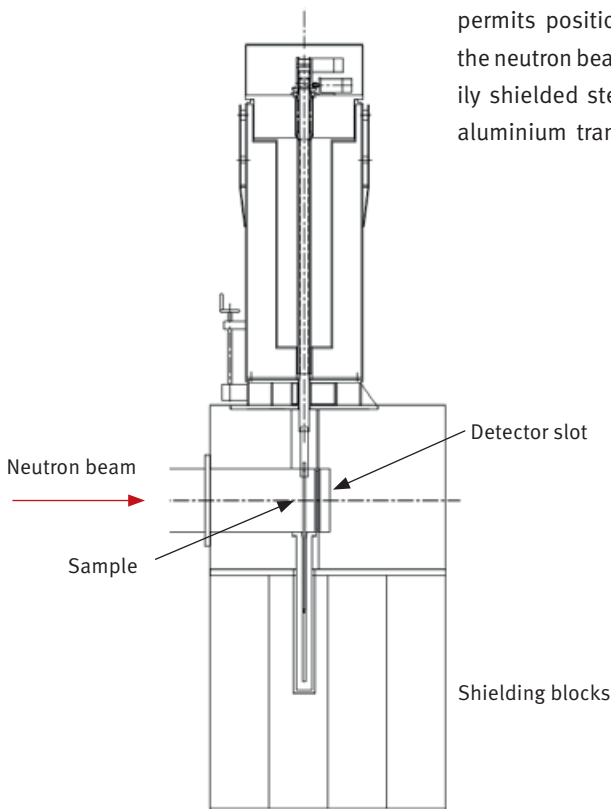

ICON

The cold neutron imaging beamline, ICON, is a versatile beamline specialized on high resolution and small samples. It has two experiment positions which are equipped with digital camera systems. Each position is equipped with motorized sample tables for exact sample positioning and turn tables for tomography. The position closest to the source can use two different camera setups. They provide fields of view from 17 mm to 150 mm and pixel sizes from 6.5 μm to 150 μm . The other experimen-

tal position has a field of view of 300 mm and is more suited for large samples. The neutron aperture is variable in five steps from 1 mm to 80 mm; this can be used to balance collimation ratio versus the neutron intensity. ICON provides several options for advanced neutron imaging. An energy selector is mounted as a plug-in with short installation times. Energy selective neutron imaging near the Bragg edges can be used to enhance the contrast of sample features since many materials have their

major Bragg-edges in the cold spectrum. A setup for neutron grating interferometry is used for phase contrast and dark field imaging (see page 25–26). By mounting a second detector off the direct beam it is possible to register diffracted neutrons and it has been proven that it is possible to make 3D reconstructions of crystal orientations. ICON also provides a cone beam X-ray setup that can be operated simultaneously with the neutron acquisition.

Comparison of NEUTRA and ICON

The flight tube of NEUTRA views the heavy water moderator tank at the position of maximal thermal neutron flux density. The end of the ICON flight tube inside the moderator tank is located near the cold source box, containing liquid heavy hydrogen at $-250\text{ }^\circ\text{C}$. Distinct neutron wavelength spectra for the two facilities result, as shown in figure right, which induce different image contrasts.

The scattering of cold neutrons by thin layers of hydrogenous material is markedly enhanced relative to thermal neutrons, leading to greater hydrogen detection sensitivity. At longer neutron wavelengths, some materials show sharp edges in neutron interaction strengths. These Bragg edges are due to scattering phenomena of cold neutrons with the material's lattice structure. Using neutron wavelength selectors, the Bragg edges may be used to enhance image contrast. More specific beamline characteristics are listed in table.

	NEUTRA	ICON
Neutron aperture D	fix: \varnothing 20 mm	variable: \varnothing 1 – 80 mm
Collimation ratio L/D	200, 350 and 550	many steps: 90 – 12 000
Neutron flux ($\text{n}/\text{cm}^2/\text{s}/\text{mA}$) (L = 7.1 m, D = 2 cm)	$7.5 \cdot 10^6$	$5.8 \cdot 10^6$
γ filter, and filter for fast neutrons	bismuth	no filter
Tomography setup	large samples	additional micro-tomography
Beryllium filter	none	optional
Neutron energy selector	none	optional
Combined X-ray investigation	XTRA	microfocus mini-XTRA
Highly radioactive samples	NEURAP	weakly radioactive samples

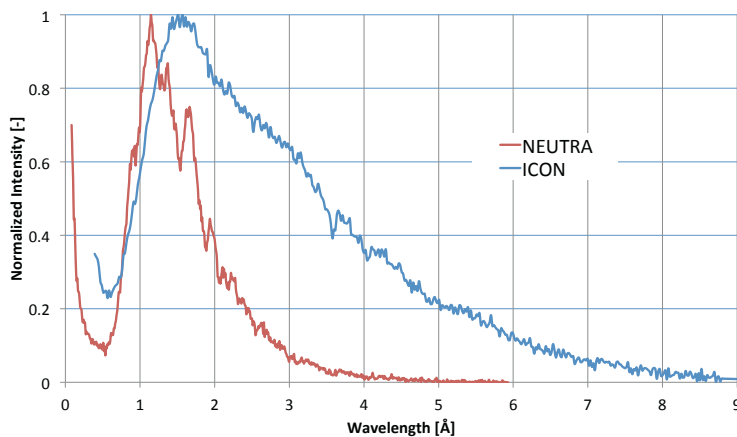

Neutron wavelength distribution of NEUTRA (red) and ICON (blue).

Detectors and methods

Principle of measurements

Neutron detection is based mainly on the creation of free electric charge carriers. Electrically neutral particles, i.e. neutrons produce such carriers by direct collisions with nuclei or neutron capture reactions that lead to the emission of charged particles (e.g. α -, β -particles, protons, tritons, ...). The most important elements for thermal or cold neutron detection exhibit very high neutron capture probabilities.

In a neutron imaging detector, the amount of electric charge produced by nuclear reactions is quite often not measured directly, but converted into another more observable physical entity such as light. In neutron scintillation screens, the charged particles stimulate light emission in zinc sulphide. The charged particles create electron-hole pairs which produce light when de-excited by laser stimulation via photostimulated luminescence in neutron imaging plates known as storage phosphors. In X-ray films, the electromagnetic radiation produced by charged particles creates a latent image in the photoemulsion, which results in selective film blackening during chemical film-development.

In the past, neutron imaging relied exclusively on X-ray films, used together with a screen converting neutrons to X-rays or light. During the last several years, digital neutron detectors have gradually replaced the analogue, film-based detection schemes. The main advantages of digital systems are: chemical development is unnecessary, the digital images can easily be stored or copied and transferred quickly over long distances, and they

can be post-processed. Additional important reasons favouring the use of digital detectors in neutron imaging are: the much reduced activation risk and the possibility of quantitative evaluation. Neutron irradiation of an object induces a – usually short-lived – activation. The shorter the neutron exposure is, the smaller the induced activity. Digital neutron detectors are more sensitive than X-ray films by orders of magnitude, permitting exposure times on the order of seconds rather than tens of minutes. In most cases the induced activity reaches safe levels within a few minutes. As described on pages 20 and 21, many digital neutron detection systems covering a broad range of spatial- and time-resolution are available. They show a linear response over a wide range of neutron exposures permitting additional quantitative information about the shape/ dimension or the composition of a sample under investigation to be derived. The requirements and aim of the

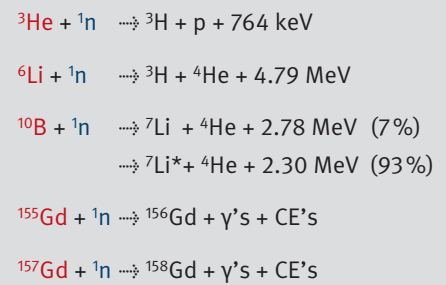

Selected thermal neutron detector materials and their reactions.

investigation determine which system should be used. By their nature, digital images allow numerical processing. Statistical or systematic image distortions can be eliminated by methods of digital image analysis e.g. noise filtering, contrast enhancement. Multiple images can easily be compared or transformed (e.g. divided) into new images. These methods are indispensable in analysing the images acquired with the elaborate techniques like tomography, time-resolved radiography or neutron phase imaging described in forthcoming sections.

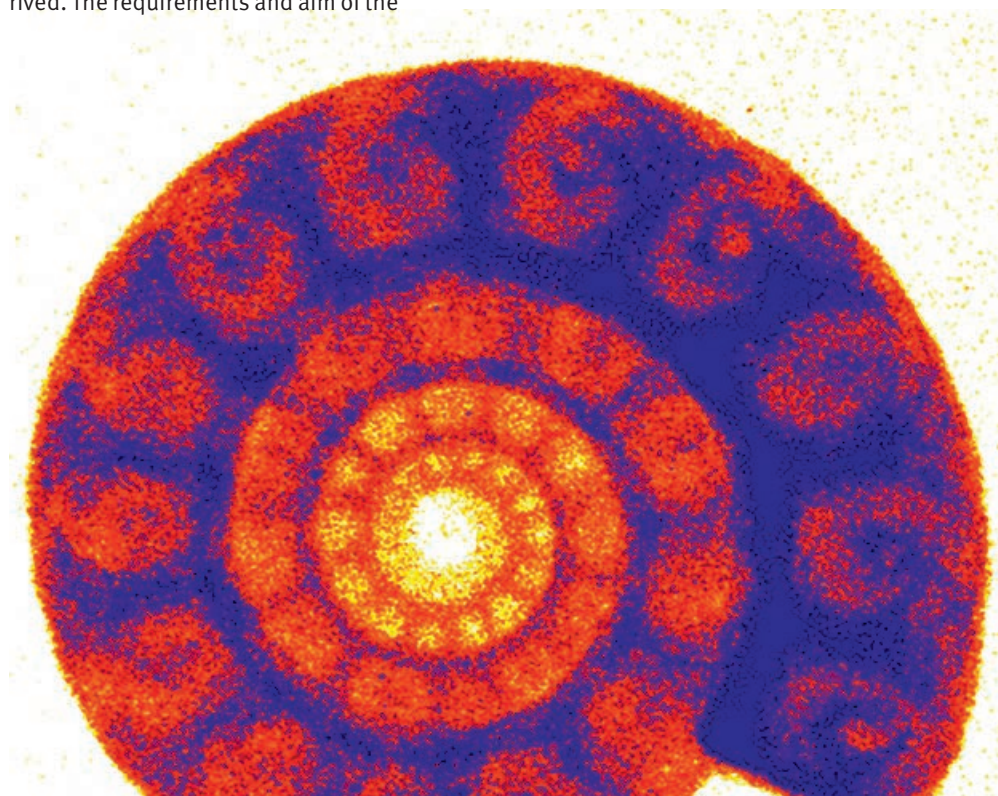

Neutron microscope

While X-ray imaging can be nowadays performed routinely with 1 μm spatial resolution at many facilities worldwide, the spatial resolution of neutron imaging is still on the quest to reach this milestone. The reasons for this lag are twofold – first, inferior availability and much lower available flux of neutron sources in comparison with the X-ray sources and, second, complexity of neutron detection process. As a result, the number of neutron facilities in which the imaging with spatial resolution about 15 μm is currently routinely performed is limited.

At the same time, the high-resolution neutron imaging has been flagged up as one of the key demands of neutron imaging user community for the future development in this field. There are ample domains that would profit from higher resolution neutron imaging,

ranging from electrochemistry, materials for nuclear safety, soft matter, and soil physics as examples on the materials science side to imaging of various biological systems on the life science side.

The “Neutron Microscope” project has been initiated at Paul Scherrer Institut with the goal to develop an instrument for the very high-resolution neutron imaging. The principal technical goal has been to develop an instrument which would allow for a sub-5 μm image spatial resolution, while allowing the images to be taken in reasonable exposure times (i.e. sub-10 minutes for the single radiographies).

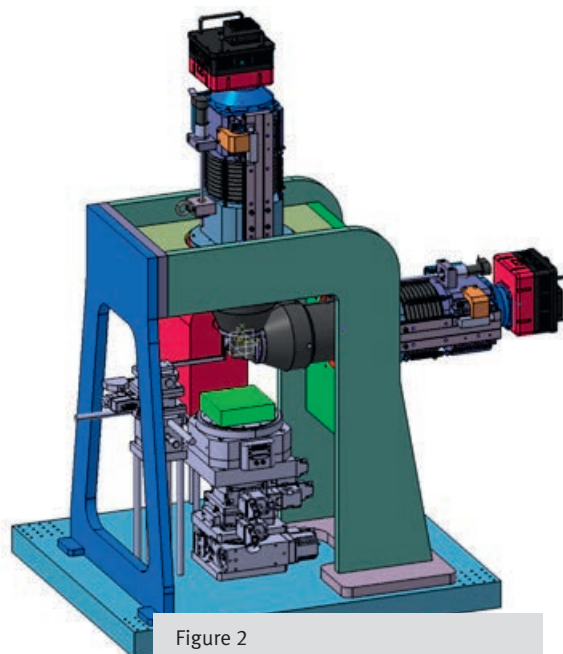

Figure 2

The “Neutron Microscope” facility is actually not “per se” based on neutron optics, but the core of instrument is based on high-NA (numerical aperture), high-resolution visible-light optics connected to very high performance neutron-sensitive scintillators). The first prototype of the instrument has been assembled and tested at PSI delivering images of about 8 μm spatial resolution – about 4-fold improvement on the resolution available from the hitherto standardly used instrument (see Figure 1) [1].

The production of the isotopically-enriched 157-gadolinium oxysulfide screens have been pioneered within the framework of “Neutron Microscope” project [2]. The isotopically-enriched scintillator screens provide nearly four-fold enhancement of the neutron capture and the light output compared to the screens made of un-enriched (natural) material, thus providing a potential for further improvement of the spatial and temporal resolution of neutron imaging.

The “Neutron Microscope” instrument (see Figure 2) is planned to become a fullfledged user-facility from 2016/17.

References

- [1] Trtik P, et al., Phys. Proc. 69 (2015) 169-176
- [2] Trtik P et al., NIM-A 788 (2015) 67-70
- [3] Kaestner A, et al., NIM-A 659 (2011) 387-393

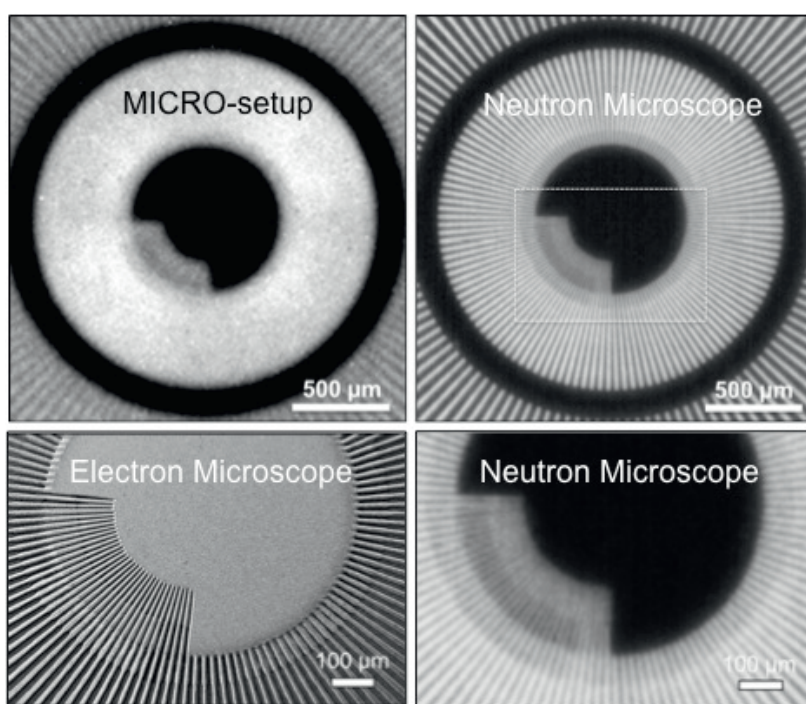
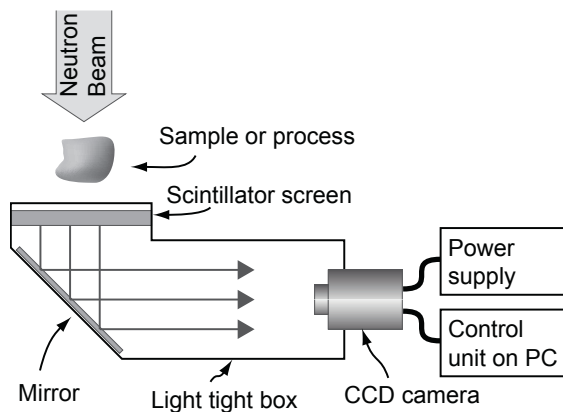

Figure 1

Detectors

Neutron scintillation screen and CCD/sCMOS camera

The cooled, light-sensitive CCD/sCMOS chip of the camera captures the light emitted from the neutron-sensitive scintillation screen. Optical lenses fitted to the camera head capture variably sized fields-of-view from 4 to 40 cm. This detector is especially useful for neutron tomography.



CCD camera with light amplifier

The light intensity can be enhanced by an amplifier for very low light applications. The amplifier can be gated, i.e. triggered at exact time points, for short exposures, permitting in particular the analysis of fast, periodic movements.

sCMOS cameras

Scientific-CMOS cameras are in many ways similar to CCD cameras. They offer a much faster readout (up to 100 fps) and generally smaller pixel size, at the expenses of more noise at very low light intensity. They are the detector of choice for fast dynamic processes of non-periodic nature.

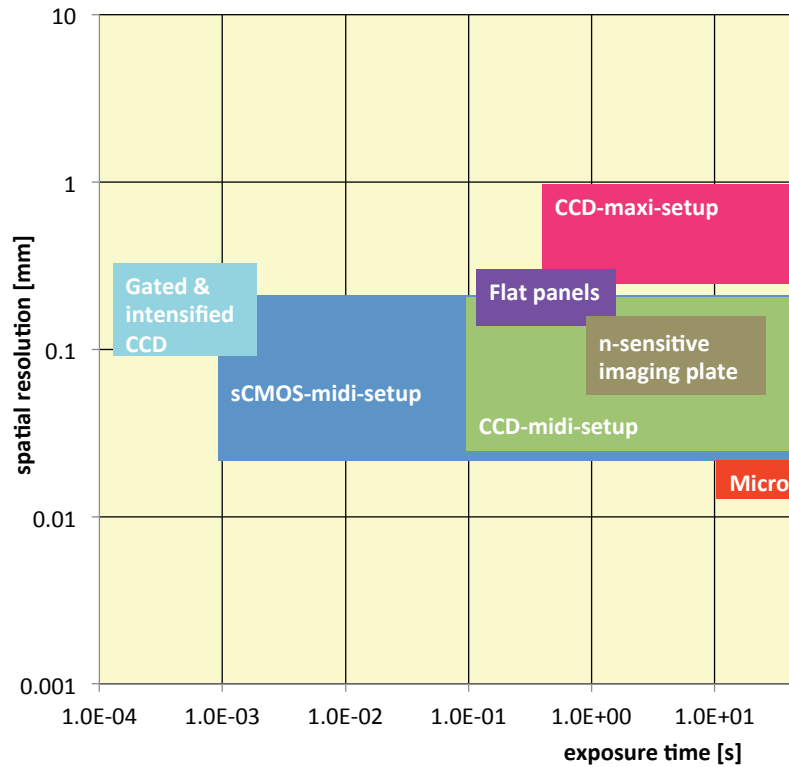

Amorphous silicon flat panel detector

Light emitted from the neutron scintillation screen is captured by a narrow array of small photodiodes in direct contact with the screen. The diodes accumulate charges, which can be read out at high frequency, permitting “real-time” neutron imaging.



Overview of the different available detectors and setups at the neutron imaging beamlines. With this extensive portfolio of options, our stations can investigate processes that span more than 2 orders of magnitude of size and more than 7 order of magnitude of duration.

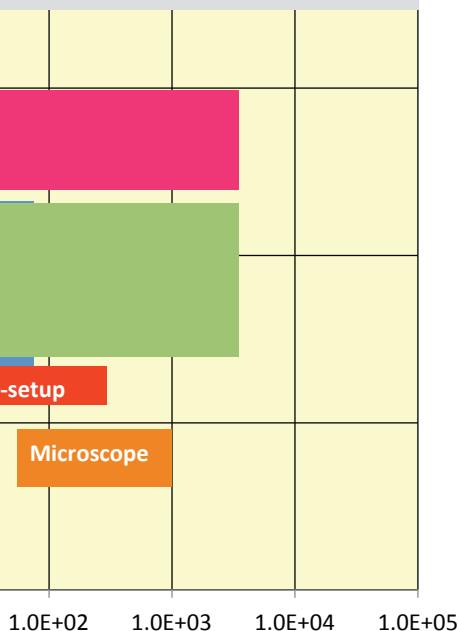

Imaging Plates

These large-area, thin, plastic-like foils capture neutrons in a matrix containing gadolinium isotopes mixed with a barium, fluorine, europium. Electron-hole pairs are generated, which, by laser irradiation, induce light emission. This photostimulated luminescence can be recorded with high spatial resolution using a laser scanning device.



MCP pixel detector

This new detector is based on the technology of Micro-Channel Plates. The neutrons are absorbed in these 10B-filled channels and they create charged particles which are accelerated and multiplied within the channel itself. This charged avalanche is read out as an event by a high-resolution (25 mm) pixel detector that is so fast as to allow the precise discrimination of the timing between events, opening up new opportunities in time-of-flight neutron imaging.

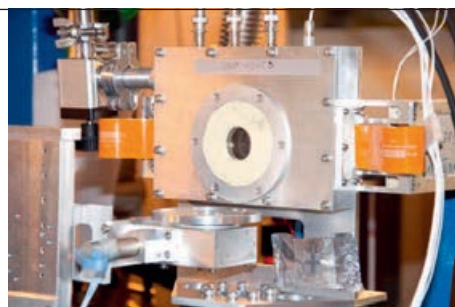

Detector system	Field of view (typical)	Pixel size [mm]	Dynamic range [gray levels]	Exposure time (typical) [s]	Read-out time [s]	Read-out rate [Hz]	Special properties
CCD-camera + scintillator	20 cm x 20 cm	0.05–0.2	40 000	0.1–300	2	0.5	variable FoV and pixel size
sCMOS-camera + scintillator	20 cm x 20 cm	0.05–0.2	65 535	0.01–30	negligible	up to 100	variable FoV and pixel size
intensified, gated CCD-camera	20 cm x 20 cm	0.05–0.2	4096	0.001–1	1–5	0.2–1	can be triggered
n-sensitive imaging plate	20 cm x 40 cm	0.05	65 535	10	300		very thin
amorphous-Si flat panel	20 cm x 30 cm	0.139	65 535	0.1–2	negligible	9–30	portable
microscope	10 mm x 10 mm	0.0013	65 535	30–600	negligible		highest reachable resolution
micro-setup	27 mm x 27 mm	0.0135	40 000	10–100	2		high resolution
midi-setup	15 cm x 15 cm	0.05–0.2	65 535	0.01–300			variable FoV and pixel size
macro-setup	30 cm x 30 cm	0.3–0.5	40 000	10–20			widest field of view

Tomography

Computed tomography is a method to acquire three dimensional information about the structure inside a sample. The method applies to neutron as well as the more known X-ray imaging. It uses radiographic projection images from many views to reconstruct the distribution of materials in the sample. Mostly, the projections are acquired with equiangular steps over either 180° or 360° to cover the whole sample. Figure right shows an experiment setup used for neutron tomography. Here, the sample is rotated using a turntable in contrast to medical imaging where the beamline is rotated around the patient. The projection images are acquired using a combination of a scintillator to convert the neutrons to visible light and a CCD camera.

The transform of the projection data into a three dimensional image is a computationally intensive task handled by special reconstruction software. During the reconstruction process, slices perpendicular to the rotation axis are produced. When these slices are stacked in a sequence they form a three-dimensional volume image of the sample.

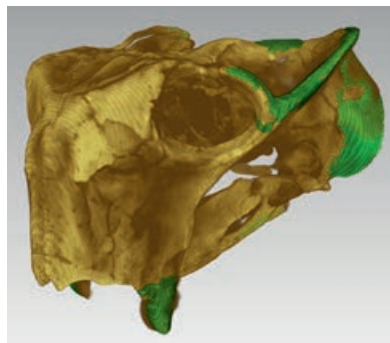
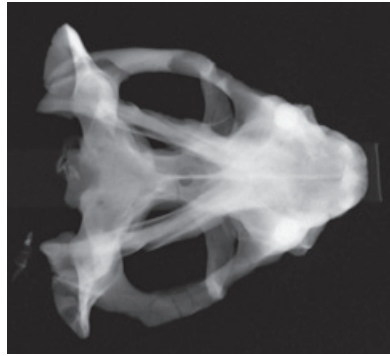

The 250 million year old skull of the mammal-like reptile *Lystrosaurus*. Top, a radiograph of the skull reveals that the structures provide sufficient contrast for a tomography. Bottom, a 3D rendering of the CT-image with segmented regions that show the restored parts of the skull. The sample was kindly provided by Dr. R. Schoch, Staatliches Museum für Naturkunde Stuttgart, Germany.



Tomography setup at ICON.

The reconstructed volume data can be visualized using three-dimensional rendering graphics software. Using such tools, regions can be segmented based on their attenuation coefficients and geometry. This can be used to reveal the inside of the sample in three-dimensions as seen by the neutrons.

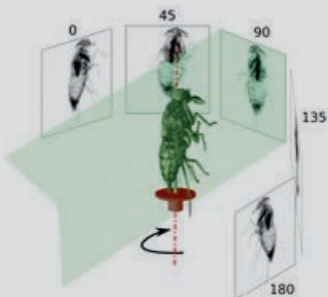

Data acquisition
300–1200 projections
Scan time 1–24 h

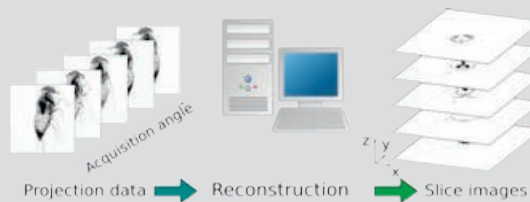

CT reconstruction
Processing time ~1 h



Data evaluation
Image processing/analysis
3D Visualization
Processing time hours or days

Time dependent neutron radio- and tomography

Dynamic neutron radiography: running engine

Rapid periodic processes which can be found as an example in a running engine can be investigated by exact chronologically triggered exposures and therefore with short exposure times. The exposures of the identical cycle positions are summed up and merged into one image. This is shown as an example for a running chain saw motor, running at idle speed with 3000 rpm. In total at 40 different crankshaft positions neutron images of the interior of the full rotation of 360 degree were acquired. The there-with obtained images can be put together to a movie. In this way the movie resembles a flip-book of the moving parts inside the motor. The current status of the measuring technology enables to take images with up to 10000 rpm.

C. Grünzweig et al, Phys. Proceed, 43, 231-242, 2012

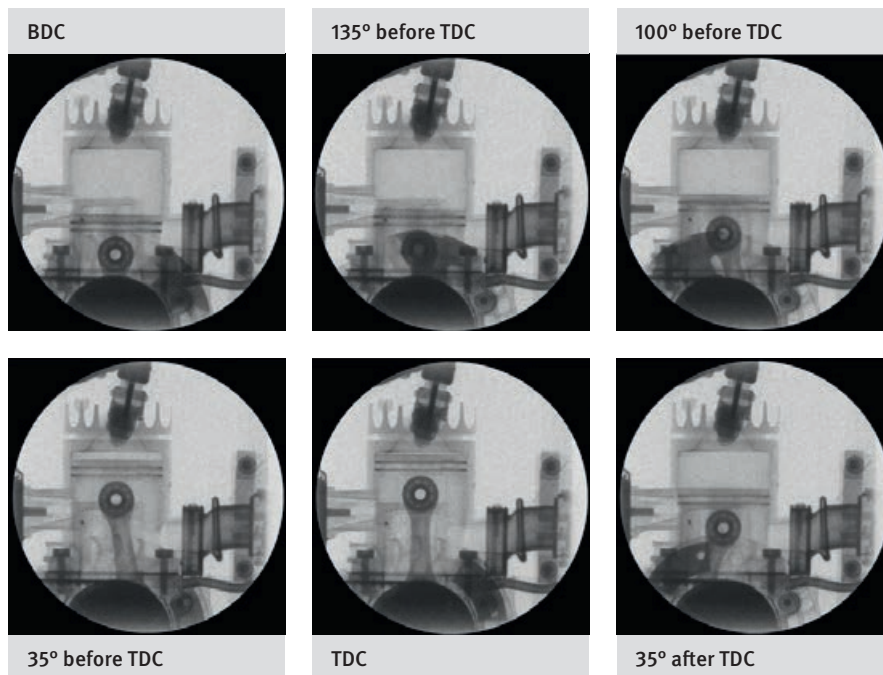

Dynamic neutron radiography images of a running two-stroke engine. The images originate during idle speed at 3000 rpm. Six different crank shaft positions out of 40 are shown. (BDC: Bottom Dead Center, TDC: Top Dead Center) The exposure time for the triggered measurement is 500 μ s.

The corresponding movie can be found:
<https://www.psi.ch/niag/dynamic-neutron-radiography>



Energy-selective imaging

Neutrons extracted from the NEUTRA or ICON flight tube have a wide range of velocities, or equivalently energy or wavelength. Images acquired with such polychromatic spectra are therefore energy averaged. Many polycrystalline materials, notably metals, show steep steps in their neutron interaction probabilities at low neutron energies. By means of energy selective imaging measurements, these Bragg edges can be used to enhance contrast or to elucidate changes in material properties. Narrow bands of neutron energies are selected by a spinning turbine wheel featuring lamellas which strongly absorb neutrons (see right figure). Only neutrons within a given velocity range pass through the wheel rotating at a selected frequency; the others are absorbed by the lamellas. Resulting wavelength spectra are shown in figure right. Figure below displays the photograph (left) and three neutron images (right) of a thick steel weld acquired with three narrow energy spectra of most probable wavelength 3.4 Å, 4.0 Å and 4.4 Å. The

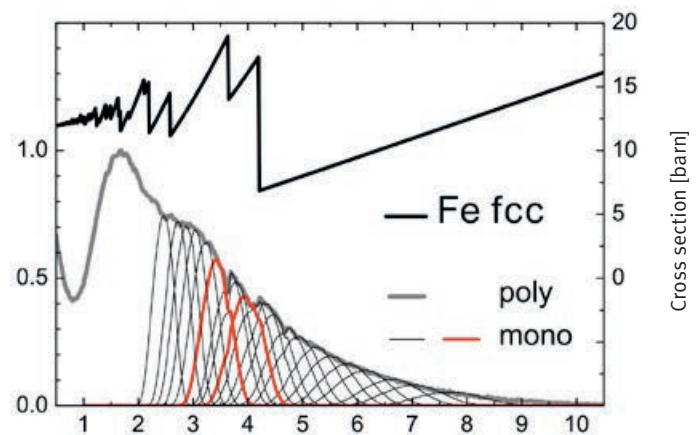
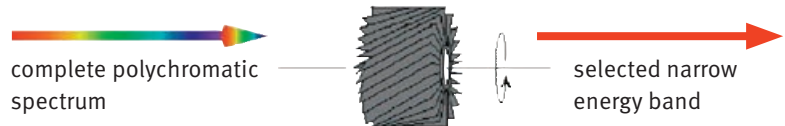

inhomogeneity in the weld, visible differentially at the three energies, is due to variations in the crystal lattice properties of the material in the weld zone. Only energy-selective neutron radiography can reveal such changes.

Selecting a neutron energy range by a spinning turbine wheel set up in the neutron flight path. The polychromatic spectrum is transformed into a narrow energy band. The neutron cross section of face centered cubic (FCC) crystalline structure iron (austenite) is shown in black.

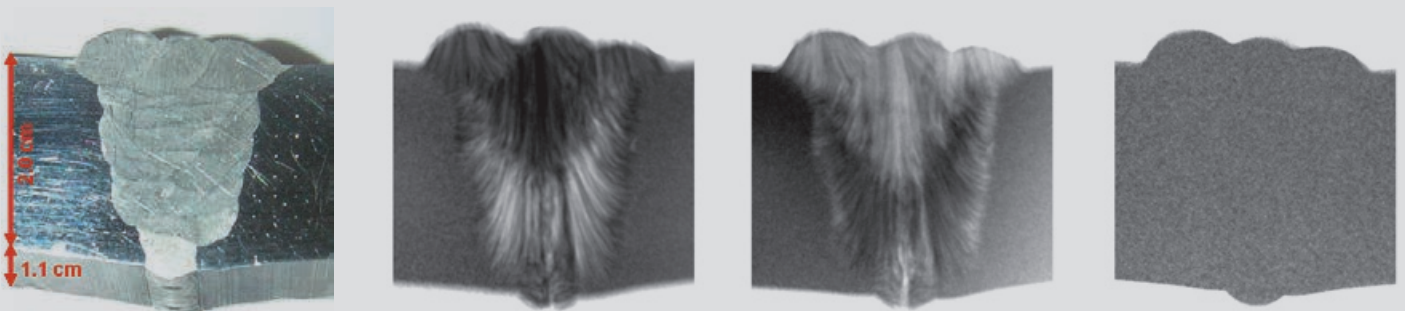

Photograph (left) and three radiographs (right) of a thick steel weld taken with three narrow neutron energy bands at most probable wavelengths 3.4 Å, 4.0 Å and 4.4 Å.

Phase contrast and dark-field microscopy with neutrons

Phase contrast and dark-field images with visible light are indispensable tools for the modern microscopy technology. PSI had succeeded to develop the corresponding imaging techniques for neutrons. Hereby quantum mechanical interaction of neutrons with matter can be made visible in two-dimensional and three-dimensional images.

Particle physicists consider neutrons as small particles; though due to wave-particle dualism neutrons can also be described by matter waves with a certain wavelength. Contrary to the conventional absorption contrast, where the contrast differences arise from the different attenuation of the materials, the image information in the phase contrast and dark-field images originate from a change in wavelength within the material.

In the case of the phase contrast method, one uses the fact that the waves which transverse an object have a different velocity to those which do not, and therefore have a different wavelength. The resulting displacement of the wave maxima leads to a change of the propagation direction and therefore to an angular change. An example from classical geometrical optics clarifies how a phase sensitive image can be obtained. By considering a beam path through a collection lens,

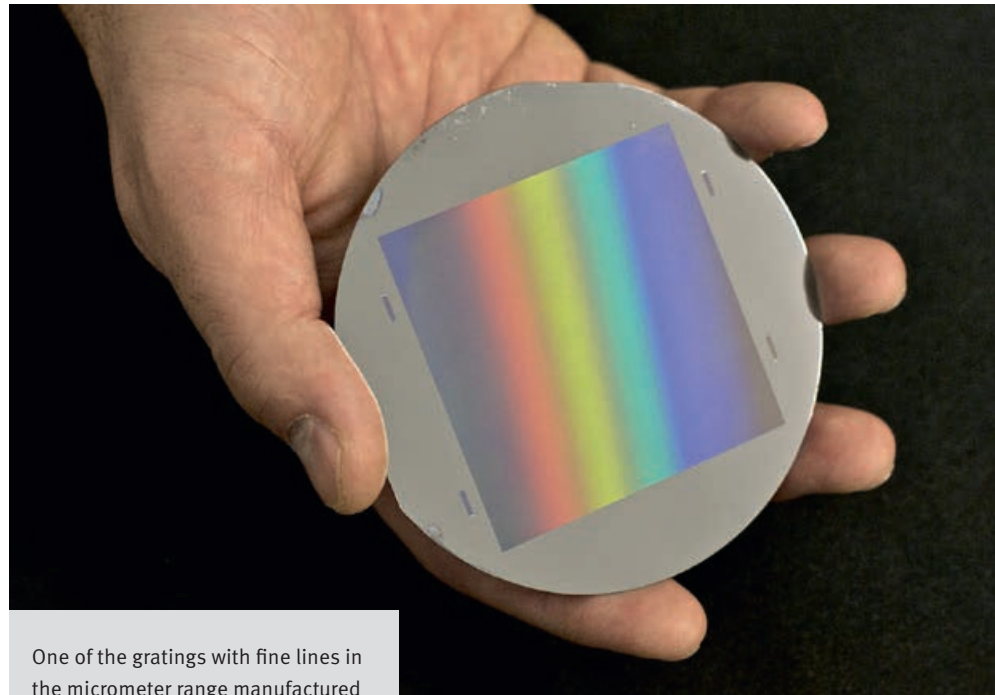

One of the gratings with fine lines in the micrometer range manufactured at PSI as used in the neutrons grating interferometer. The wafer has a diameter of 100 mm. The grid area is $64 \times 64 \text{ mm}^2$. The rainbow is caused by the refraction of light at the fine structures of the grating.

it follows from the law of refraction that initially parallel light rays are refracted towards the optical axis. In a wave-optical description this corresponds to a lens induced angular change of the light rays, and namely a spatially dependent phase shift of the wave front.

In order to obtain phase contrast imaging, we measure the local angular variation of the neutron beam caused by the object. The experimental difficulty is therefore to measure efficiently, for a variety of image points, such small diffraction angles, in the range of 10^{-4} degrees. Therefore one uses two grids (G1 and G2) which are composed of lines with lattice constants of a few micrometers. Such a grating is shown in Figure on this side above. The gratings together with a spatially resolving neutron detector then form the so-

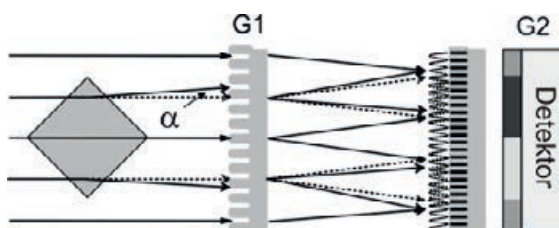
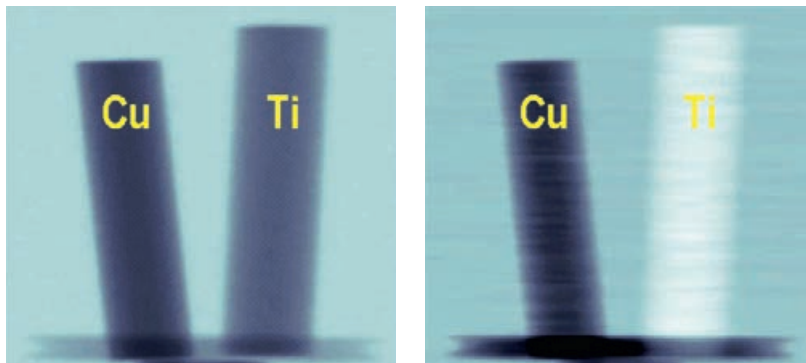

Illustration showing the setup of the neutron grating interferometer, consisting of a phase and an absorption grating and an imaging detector. With the help of this setup neutrons can be detected, which have been deflected or scattered at an angle of 10^{-4} degrees.

called neutron grating interferometer, as depicted in the Figure page 25 below. The local angular change can be determined by pixel wise analysis of the measured intensity.

Measurements of the phase shift of neutrons in interferometry experiments have been used so far to experimentally verify quantum mechanical predictions. The work at PSI aims to combine the available information about the phase shift with a space-resolved imaging technique, in order to image the quantum mechanical interaction of neutrons with matter and to offer new contrast possibilities.

Figure above shows the results obtained for test samples. The conventional neutron absorption image (left) shows no measurable difference in the attenuation behaviour of the two metals, Copper and Titanium. The image of the measured phase shift (right), however, clearly shows a difference. Particularly interesting is the opposite sign of the phase shift of Copper (black in the image against the gray background) and Titanium (white to gray); this is a consequence of the different signs of



Measured neutron images of two metallic rods with a 6 mm diameter and made of Copper and Titanium. (Left) Conventional absorption image; (right) phase contrast image.

F. Pfeiffer et al, Phys Rev Lett, 96, 215505, 2006

the refractive indices of the materials. For the dark-field imaging method the scattering properties of the interior of the materials is considered, resulting in Neutrons being scattered during their passage through the material; the passage through the material consists of interactions with materials of different refractive indices, resulting in a small angle change. This method can be used, for example, to visualize

magnetic domains in ferromagnetic materials, as shown in Figure below. Neutrons are de-flected due to the interaction of the neutron spin with the local magnetic fields, since magnetic domains with different orientations have different refractive indices. Therefore, neutrons are scattered in the transition from one domain to the next at the domain walls, seen in the dark-field image as white lines.

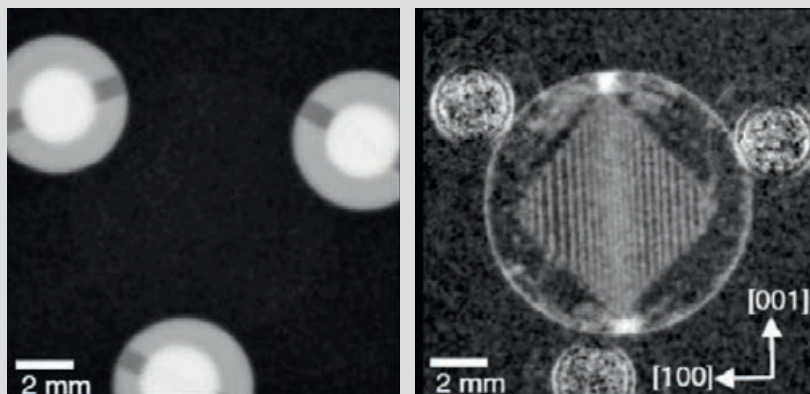

Measured neutron images of a magnetic sample (Silicon Iron) in the form of a disk with a thickness of 300 microns and a 10 mm diameter. Left: Conventional absorption image; Right: Dark-field image. The white lines which form a rhombus are magnetic domain walls.

C. Grünzweig et al, Appl Phys Lett (93), 112504, 2008

Scientific use

Research into wood and soil:

Precise analyses of moisture content in wood samples

Nuclear technology:

Examination of fuel elements and quality control

Palaeontology:

Examination of fossils

Hydrology and geology:

Analyses of rock formation or geological transport processes

Archaeology and museum research:

Research into bronze and iron objects or paintings

Materials research:

Investigations of alloys, welds, etc.

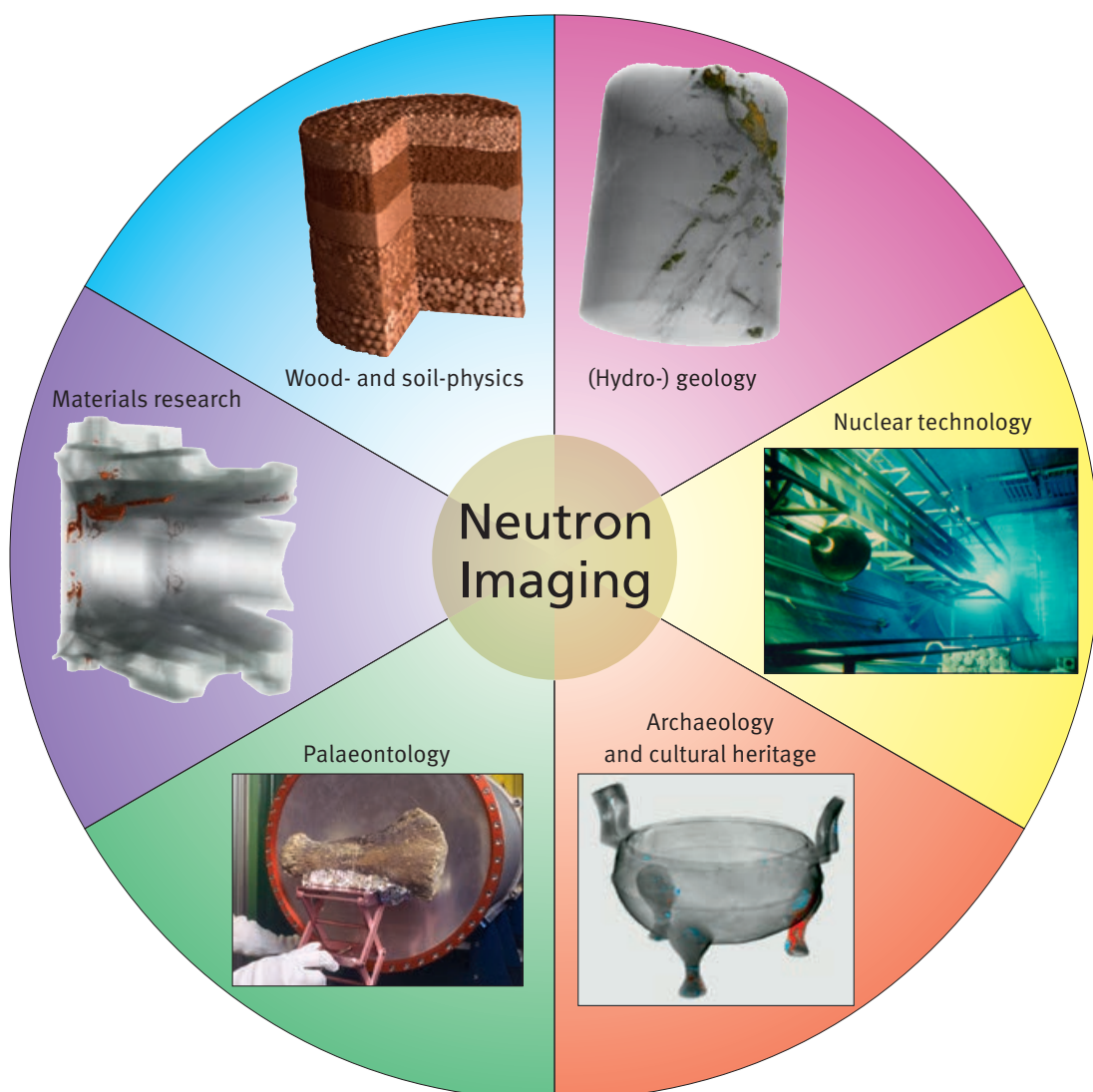

How neutrons see plant-soil interactions

The water balance between atmosphere and land surface is often dominated by the influence of vegetation, and water is a limiting factor in the cultivation of agricultural crops. However, water uptake by plants and its feedback to soil water is not yet understood in detail. Using neutron imaging of plant roots in soils, it is now possible to gain new insights into root-soil interaction. With this method, a new mechanism was found that allows roots to sustain their water supply during dry conditions.

Neutron imaging was performed at the NEUTRA and ICON beamlines of SINQ, at PSI. Different plant species (white lupin, chickpea, and maize) were grown in cylinders (height: 100 mm, diameter: 27 mm) filled with a sandy soil. When

Measured soil water distribution around the roots of a plant. In this horizontal cross-section, the white zones represent roots, while the regions in colour show how much water is present in the soil – red means a larger amount of water.

A. Moradi et al, *New Phytologist*, 192:653, 2011

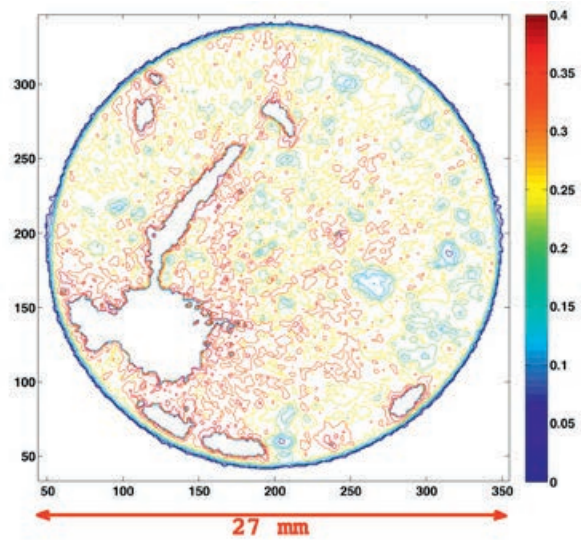

the plants were 12 days old, we started to scan the samples. Tomography acquisitions of the samples were taken over the course of 4 days and monitored the changes in soil water content around the roots as they took up water

and dried the soil. Contrary to current models of root water uptake, which predict a drier soil close to roots, we consistently observed higher soil water content closer to roots than far away from them.

Renaissance bronzes

Renaissance bronzes from the Rijksmuseum Amsterdam were investigated by neutron tomography in order to study their casting. Old bronzes usually have

a quite high lead content, which make them ideal candidates for nondestructive analysis by neutron tomography. From the tomographic volume, virtual slices can be generated, revealing the inside of the bronze as figure below

shows. The shape and size of bronze hollows or additional filling materials yield conclusions about the casting process. Resins or varnish used for the conservation of sculptures appear with high contrast.



Tomographic views of a bronze sculpture: virtual slices and transparent views can be created without damaging this unique object.

Photo: Rijksmuseum Amsterdam

See animations at: <https://www.psi.ch/niag/bronze-sculptures>

Water distribution in fuel cells

Polymer electrolyte fuel cells (PEFCs) are seen as an attractive alternative to internal combustion engines in automotive applications, because of their high efficiency and the absence of pollutant and CO₂ emissions. They produce electrical energy thanks to an electrochemical reaction between hydrogen (the fuel) and oxygen which can be taken from the atmosphere. The product of this reaction is water which usually condensates at the typical operating temperature of these fuel cells (70–80 °C), and the accumulation of water in the flow channels and porous media dedicated to the supply of hydrogen and air can result in performance loss.

Neutron imaging has characteristics making it a very valuable tool for fuel

cell research. First, the neutrons can penetrate through high thicknesses of materials such as steel (up to 10 mm) or aluminum (up to 10 cm). This allows imaging the water in fuel cells with minimal or even without any modification of their construction. Second, the hydrogen contained in water provides a high contrast for neutrons, allowing the detection of water thicknesses as small as a few micrometers. Thanks to this unique combination, neutron imaging is a highly demanded method for the study of water management in fuel cells.

At PSI, both conventional *through plane* imaging and high resolution *in plane* imaging are performed. For the latter, we use anisotropic enhancements developed specifically for fuel cell application. A recently developed setup even allows the simultaneous operation and imaging of up to 6 fuel

cells, which is of high interest for materials comparison and reproducibility studies.

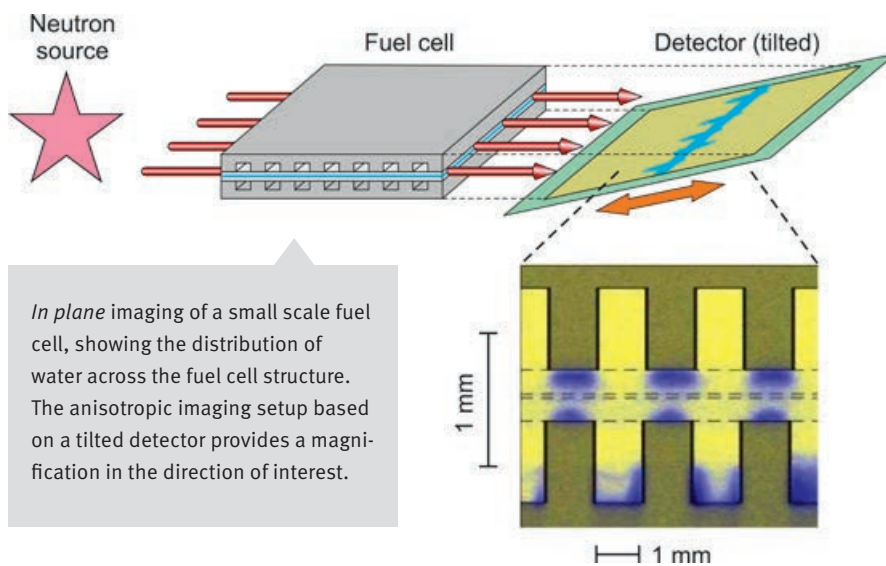
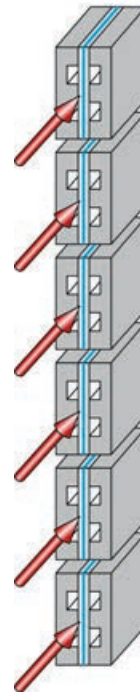

In plane imaging of a small scale fuel cell, showing the distribution of water across the fuel cell structure. The anisotropic imaging setup based on a tilted detector provides a magnification in the direction of interest.

With the multicell setup, up to 6 small scale operating fuel cells can be imaged simultaneously
P. Oberholzer et al., Electrochem. Commun. 20, 67 (2012)

Through plane imaging of a 50 cm² fuel cell, showing the detailed water distribution during operation.
P. Stahl et al., J. Electrochem. Soc. 162, F677 (2015)

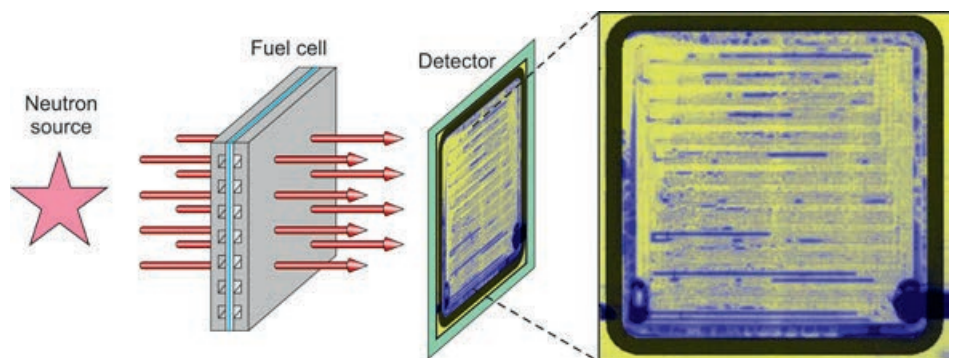

Neutron imaging of nuclear fuel

Traditional X-ray investigations of nuclear fuel elements are almost impossible, since irradiated nuclear fuel is a strong emitter of γ -rays. Contrary to X-rays, neutrons easily penetrate heavy metal samples like e.g. UO_2 . Therefore, neutron radiography, using area detectors sensitive to neutrons only, permits the nondestructive evaluation of highly radioactive material. Fuel rod segments

from nuclear power plants are investigated in collaboration with the PSI hot cell facility. They must be transported and manipulated with in heavily shielded containers and equipment as provided by the NEURAP setup presented on page 16. The aim of nuclear fuel investigations is to check the integrity of fuel pellets after long term irradiation (figure below) or to evaluate the corrosion of zircaloy cladding material (figure below middle). The high sensitivity of thermal neutrons to the

U-235 isotope can be used to check isotopic enrichment by neutron transmission measurements (figure below bottom).

Radiographic inspection of nuclear power plant fuel rod segments: single fuel pellets show fractures and chips (top), zirconium hydride lenses due to cladding corrosion (middle), or fresh fuel pellets with varying isotopic enrichment (lower).

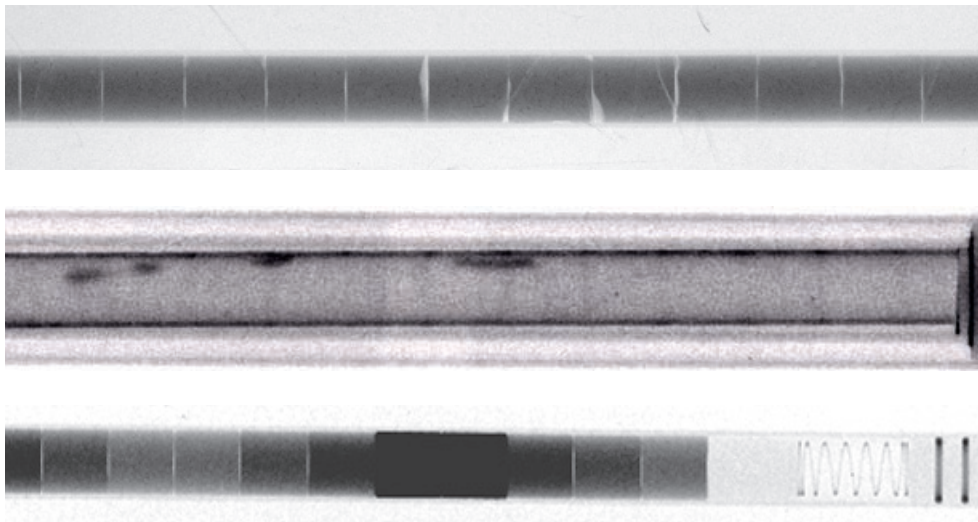

Palaeontology

Neutron radiography permits nondestructive evaluation of large fossils. The figure below shows the photograph and

neutron radiograph of the partly dissected head and neck of an ichthyosaur. In the tomographic study of the head section, the skeleton can be segmented from the surrounding sediment. If suffi-

ciently precise details about skeleton can be retrieved, further restoration steps can be envisaged to yield additional insight into the development of ichthyosaurs.

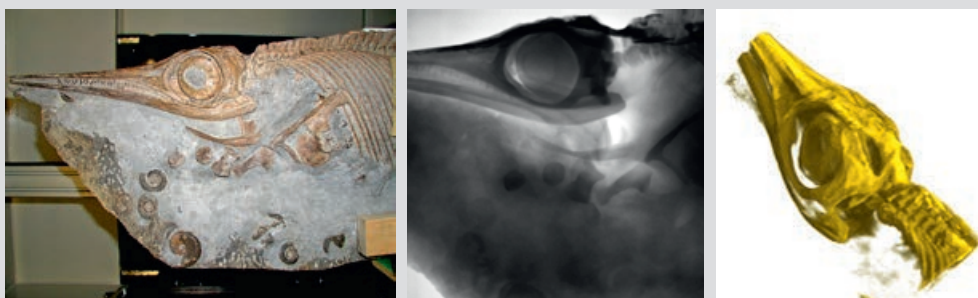

Fossilised skeleton of an ichthyosaur partially dissected by U. Oberli, St Gallen. Photograph (left), radiograph (middle), and tomographic view of head section (right).

Industrial applications

Welding, soldering & brazing:

Quality assurance and tightness, integrity

Fuel cell performance:

Water production rate and local distribution

Two-phase flow:

Water detection in metal pipes, time dependent, e.g. refrigerator

Adhesive connections:

Glue distribution, in particular behind thick metal layers

Structural integrity and performance:

Observation for cracks, corrosion after operation

Combustion engines:

Real time studies of running devices, Diesel particulate filter performance

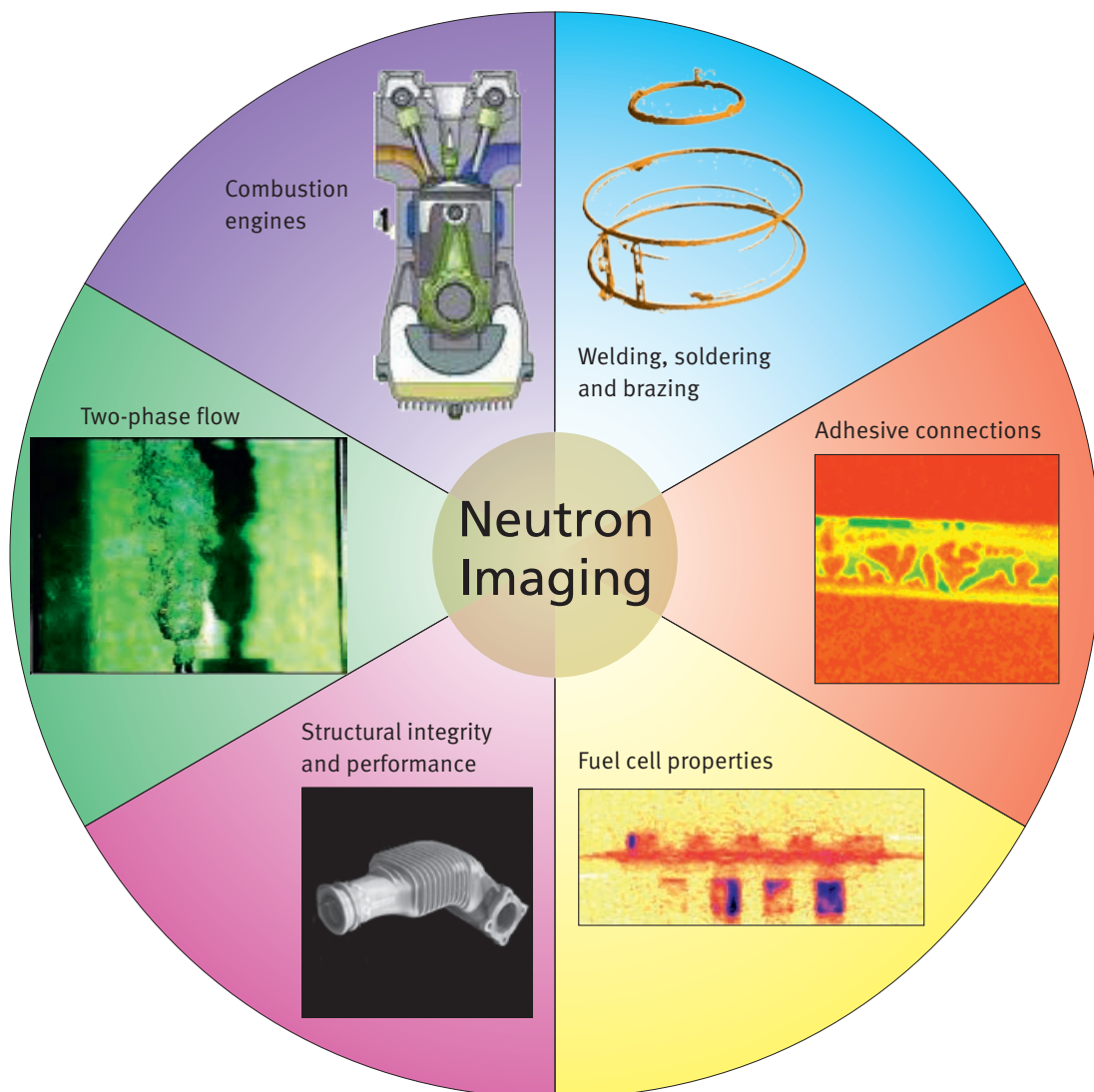

Industrial applications

Neutron Imaging is in use as a tool for nondestructive and non-invasive inspection of industrial components. The higher standards in safety issues, the permanent improvement of material properties and more complex structures in industrial systems require more sophisticated techniques for diagnostics.

Here, neutron imaging fits in as a complementary option in respect to the

well-known X-ray techniques which are also under progressive improvement.

The example in figure on the right of an actuator shows impressively the difference in the image results of the two methods – neutron and X-ray inspection. Whereas neutrons better identify plastics and sealing materials, the X-rays show metallic components while “ignoring” organic materials more or less.

Neutron imaging techniques can favorably be applied when larger metallic

components have to be transmitted and small amounts of hydrogenous materials have to be visualized.

Neutron tomography is presently the only possibility to obtain information about the three-dimensional distribution of soot and ash in a filter monolith. The estimation of the soot distribution in a diesel particulate filter with neutron imaging is possible because neutrons are highly sensitive to the element hydrogen, which is content of soot.

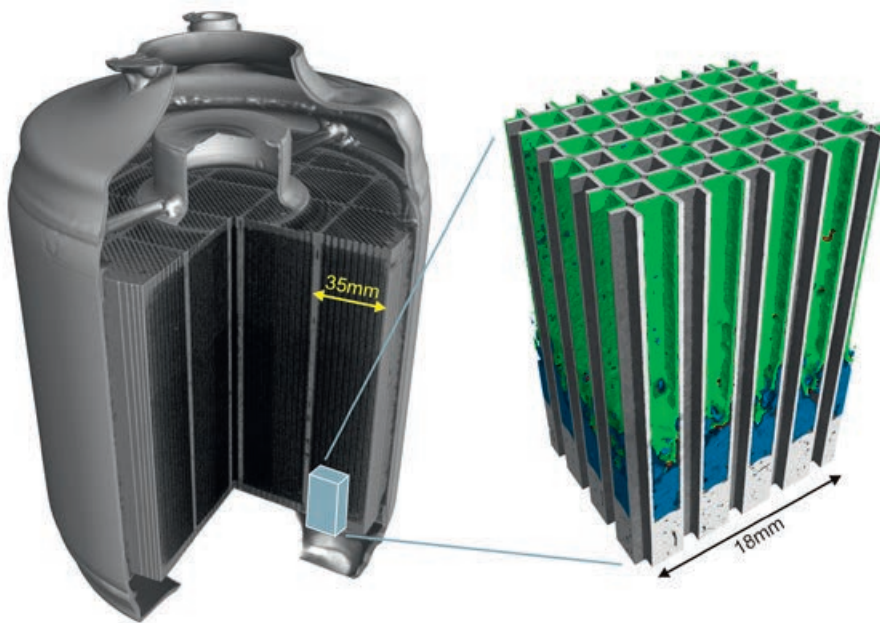

Neutron tomography data of a loaded diesel particulate filter: (left) The steel jacket is no barrier for neutrons and allows an insight into the loaded monolith. (right) High-resolution tomography of a piece of the monolith. Green color indicates the soot, the blue color indicates the ash.

C. Grünzweig et al, MTZ Motortech-nische Zeitschrift 73, 326 (2012)

Adhesive connection of a metallic car component (photo left) where neutron tomography allows a separation of the glue (red colored) from the metallic structure; the inhomogeneous distribution becomes obvious and might limit the solidity of the structure.

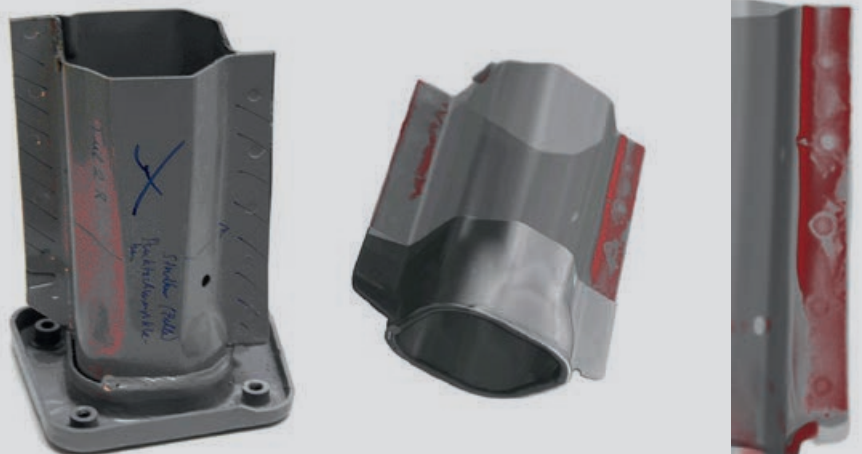

There are also some materials with a high absorption ability (B, Cd, Li, Gd,...) for neutrons which can be observed in very high detail and sensitively inside structures.

Based on these main features of neutron imaging the following principle categories of industrial applications could be identified until now:

- Gluing connections between metals and other materials
- Solder and brazing connections of metals
- Casting failures and structural defects in metals
- Thin films of lubricants, water, corrosion and lacquer
- Periodic processes (running engines, pumps, injectors, ...)
- Deposits in filters and on sensors in small amounts
- Water deposition and distribution in running electric fuel cells

There is certainly the potential for further applications for industrial partners. First tests will be done on demand in order to define the performance for the particular study and find out the best possible boundary conditions.

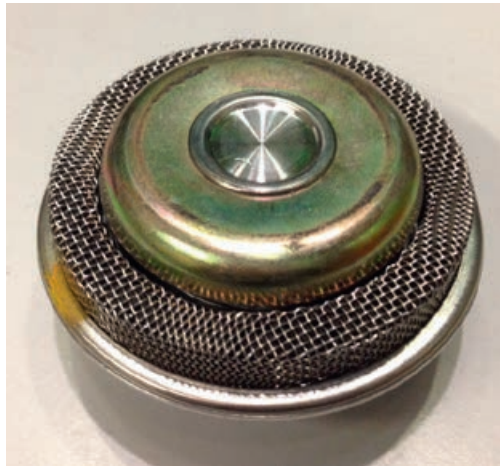

Car airbag inflator module.
3D cut view created by neutron tomography. Part of the gas-forming salt is shown in red.

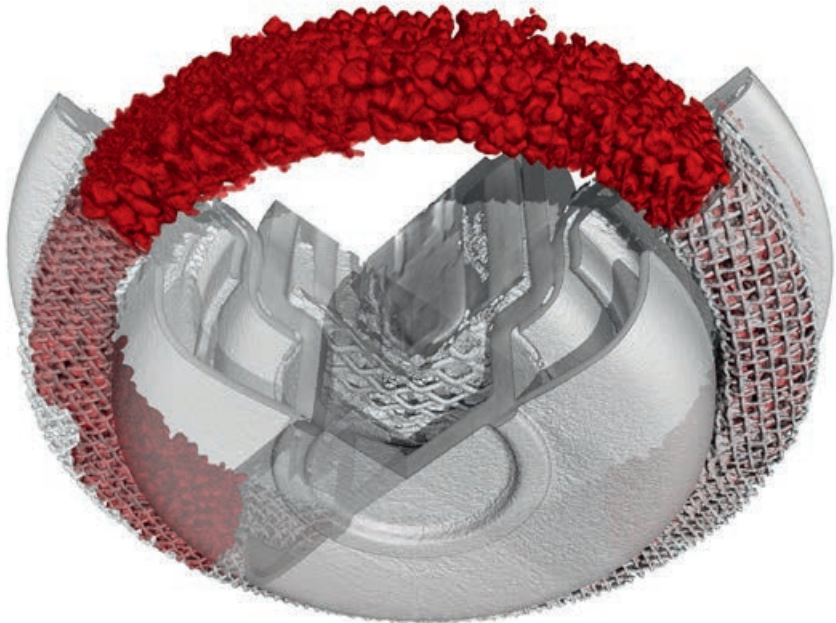

A non-invasive inspection tool for boron containing soldering connections is found in neutron imaging. A destructive inspection is not required when neutron tomography is applied to the object on the left. By suitable software tools the metal can be separated from the solder distribution show on the right.
C. Grünzweig et al, 9th Int. Conf. Proc. on Brazing, High Temperature Brazing and Diffusion Bonding (2010)

Outlook

Neutron Imaging with polarized neutrons

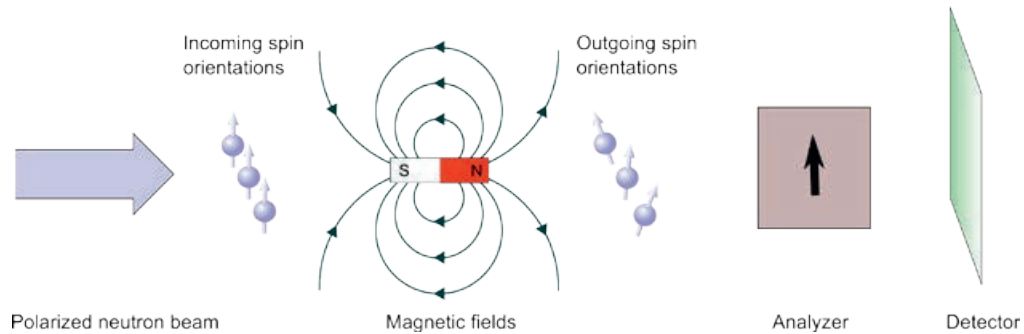

It is well known that neutrons as elementary particles obey a spin which occurs in two states (up/down). A neutron beam extracted from a source contains both states in the same amount, Polarized neutrons with only one spin state can only be obtained if the other state is sorted out by means of different filter options which absorb and suppress 50% of all neutrons.

Neutrons also carry a magnetic moment which follows the spin orientation. In this way, neutrons can be considered to be small microscopic magnets. They can be arranged in a magnetic field and precess around the direction of the field.

This property of the polarized neutrons enables to visualize directly magnetic structures, the distribution of magnetic fields and effects of magnetization in different materials.

For this purpose, a setup is needed as shown in Figure: after their polarization the neutrons hit the area with the magnetic relevant structure where a variation of the distribution of the polarized neutrons happens. This influence of the magnetic effects onto the distribution of the polarized neutrons can be measured by means of a neutron sen-

sitive imaging detector arranged behind the analyzer of the polarized neutrons.

The principle of this kind of measurements has already been demonstrated [1]. At PSI we intend to establish and to improve the method by using the BOA beam line which already delivers a highly intense polarized beam in order to improve the spatial resolution and to reduce the acquisition time in the measurements. New magnetic materials and magnetic phenomena should be investigated and visualized on the macroscopic level.

Reference:

- [1] M. Morgano, et al., NIMA, 754, 46-56, (2014)
doi:10.1016/j.nima.2014.03.055.

Principle setup of experiments with polarized neutrons for the study and visualization of magnetic phenomena

Visualization of the magnetic field lines inside a rectangular coil with electrical current passing through its spires. The contrast is given by the different precession angles applied to the polarized neutrons by the magnetic field.

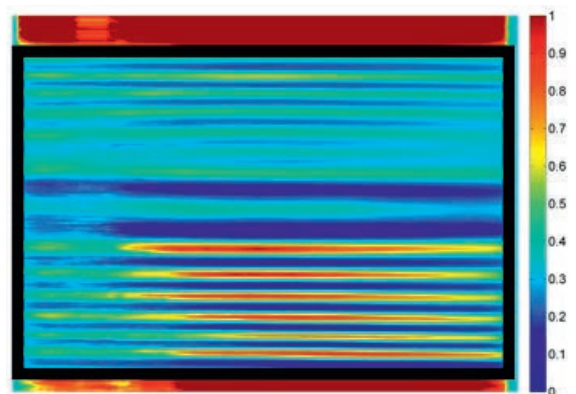

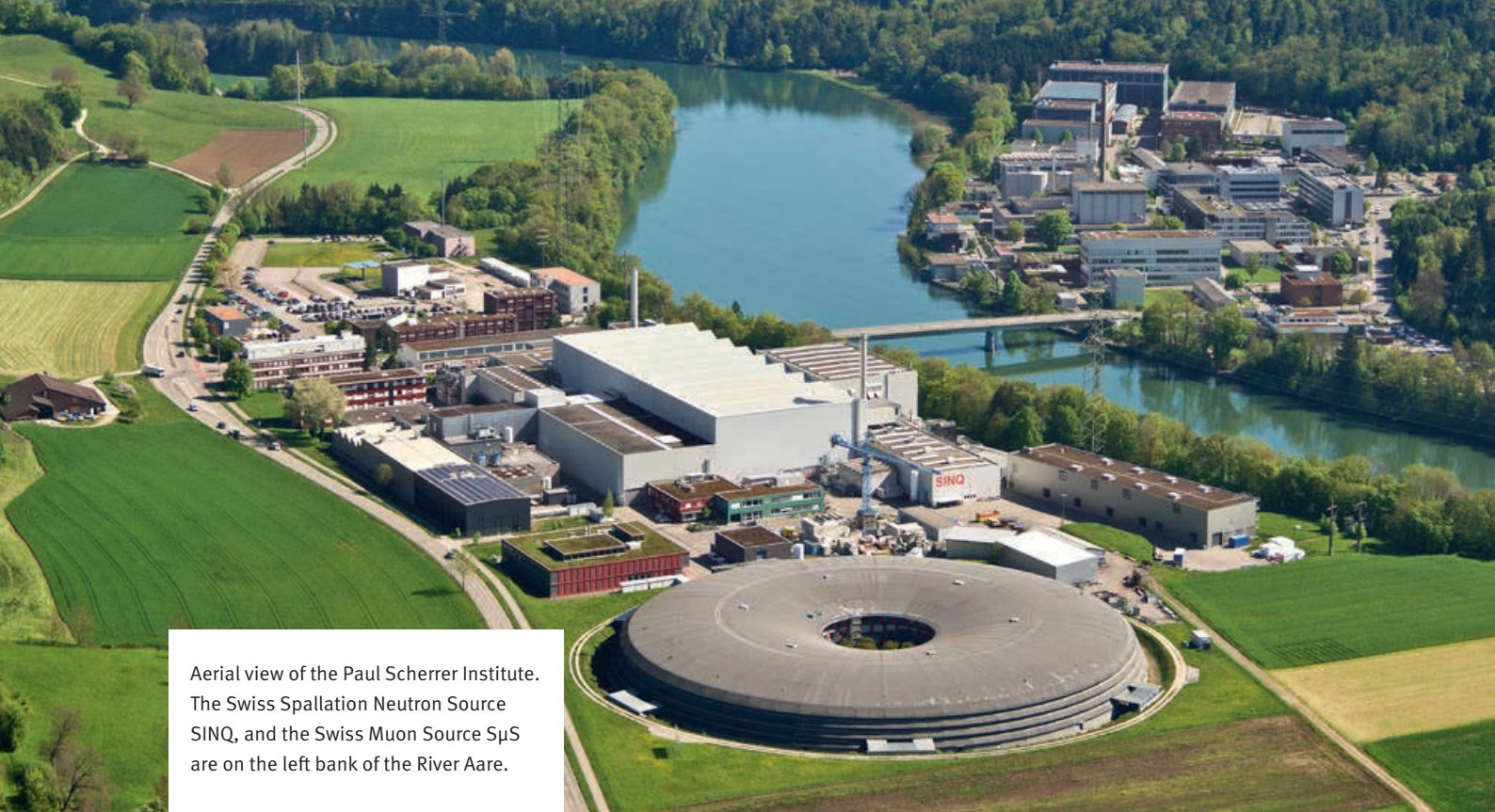

Aerial view of the Paul Scherrer Institute. The Swiss Spallation Neutron Source SINQ, and the Swiss Muon Source μS are on the left bank of the River Aare.

PSI in brief

The Paul Scherrer Institute PSI is a research institute for natural and engineering sciences, conducting cutting-edge research in the fields of matter and materials, energy and environment and human health. By performing fundamental and applied research, we work on sustainable solutions for the major challenges facing society, science and the economy. PSI develops, constructs and operates complex large research facilities. Every year more than 2500 guest scientists from Switzerland and around the world come to us. Just like PSI's own researchers, they use our unique facilities to carry out experiments that are not possible anywhere else. PSI is committed to the training of future generations. Therefore about one quarter of our staff are post-docs, post-graduates or apprentices. Altogether PSI employs 2000 people, thus being the largest research institute in Switzerland.

Imprint

Concept/Editor

Neutron Imaging & Activation
Group (NIAG)

Photography

Scanderbeg Sauer Photography
NIAG, H.R. Bramaz

Layout/Printing

Paul Scherrer Institut

Available from

Paul Scherrer Institut
Events and Marketing
5232 Villigen PSI, Switzerland
Tel. +41 56 310 21 11

Villigen PSI, July 2016

Contacts

niag@psi.ch



NIAG: <http://www.psi.ch/niag>



NEUTRA: <http://www.psi.ch/sinq/neutra>



ICON: <http://www.psi.ch/sinq/icon>



Industrial Applications:

<http://www.psi.ch/sinq/icon/industrial-services>

Paul Scherrer Institut :: 5232 Villigen PSI :: Switzerland :: Tel. +41 56 310 21 11 :: www.psi.ch

Neutron Imaging_e, 7/2016

