



Sandia  
National  
Laboratories

*Securing the future of Nuclear Energy*



# Considerations in Modeling Experiments with MELCOR

SAND2023-01789PE

Larry Humphries



Sandia National Laboratories is a multimission laboratory managed and operated by National Technology and Engineering Solutions of Sandia, LLC., a wholly owned subsidiary of Honeywell International, Inc., for the U.S. Department of Energy's National Nuclear Security Administration under contract DE-NA0003525.

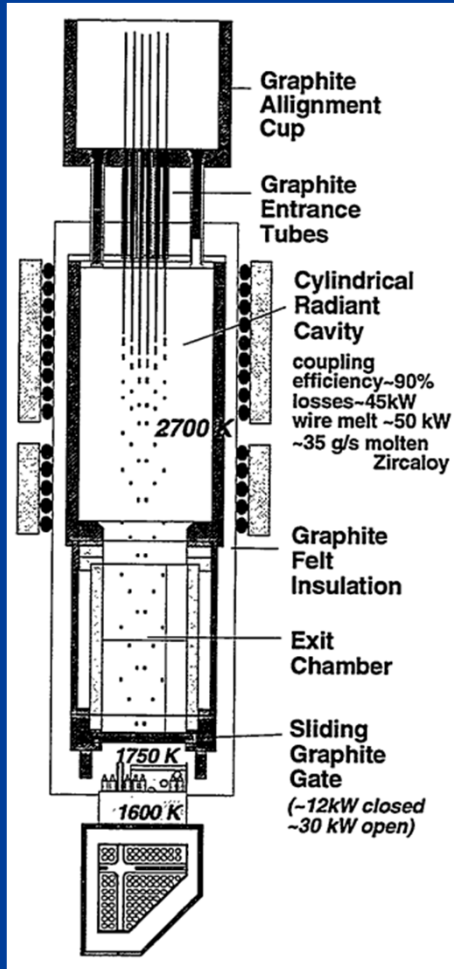

## MELCOR Modeling of Experiments

- Objectives in modeling experiments
  - Validation of physics models
    - Assessment of physics models and current model parameters with experimental data
      - Intention is not to capture data by tweaking input parameters
  - Reduce uncertainties in model parameters
    - Sensitivity calculations are performed to refine model parameters and reduce uncertainty in simulations
- Over-arching modeling guidance
  - When possible, modeling of experiment should be as prototypic as possible
    - Nodalization should be comparable to working plant decks (within the limits of the experiment scale).
    - Default values of sensitivity coefficients should be used for base calculations (sensitivity studies to refine model parameters)
- Special Considerations for Experiments
  - Scale of experiments different from plant simulations
    - May require modification of physics model parameters
    - May require modification of boundary conditions
    - Always consider the physics that is being assessed by the experiment.
      - It may be okay to depart from traditional modeling approach to obtain the correct boundary conditions to adequately assess the physics of interest

# Properly Modeling Boundary Conditions DEMONA

• Two approaches at modeling DEMONA Test.

Poor agreement

• 1<sup>st</sup> approach: Skip modeling of phase 1 & phase 2 using specified atmosphere conditions and assume temperature distributions of heat structures.

Good agreement

• 2<sup>nd</sup> approach: Model the heat up phase by injecting steam and air from a fixed condition boundary CV. This boundary CV was then valved closed during aerosol phases and steam/air were injected as sources.

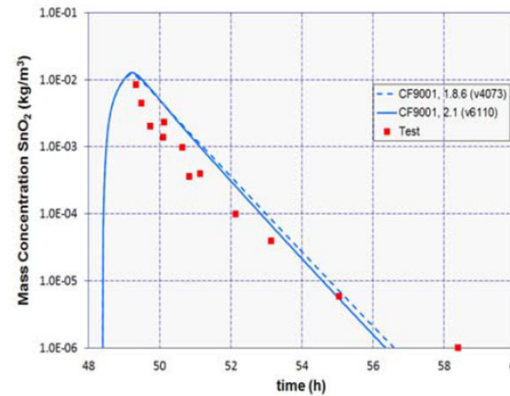
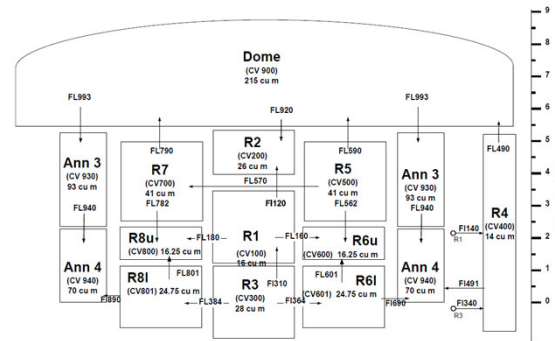

Phase 1: The air was purged to achieve a pure steam atmosphere (0.4-7.1 h).  
 Phase 2: Inject steam over 2 days to heat up structures, at a constant pressure of 1.7 bar.  
 Phase 3: Hot air and aerosol were injected from 48.4 to 49.3 h, raising the pressure to 3 bar (partial pressures, air 1.3 bar, steam 1.7 bar). A small amount of steam was also injected to maintain the 1.7 bar steam partial pressure. The measured peak aerosol concentration was 9 g/m<sup>3</sup>.  
 Phase 4: Aerosol depletion 49.3-71.1 h. During this phase the pressure was kept  
 • constant at 3 bar by controlling the steam injection rate. Some air leakage occurs in the facility, so the air partial pressure slowly decreases and the steam pressure increases. The aerosol concentration was measured during this phase.  
 Phase 5: Cooldown

# Properly Modeling Boundary Conditions NUPEC

## Two approaches at modeling NUPEC Test

Poor agreement  
Good agreement

- 1<sup>st</sup> approach: Model all containment surfaces and perform initialization calculation but do not implement the film tracking model.
- 2<sup>nd</sup> approach: The film tracking model proved extremely important in this experiment to adequately capture HS temperatures and therefore natural convection in the containment.

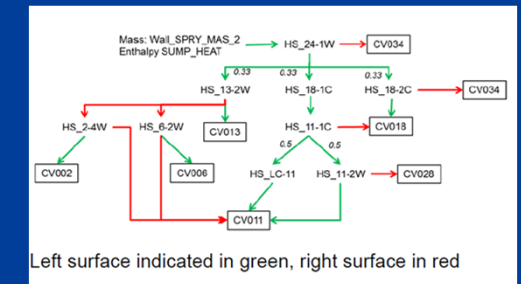
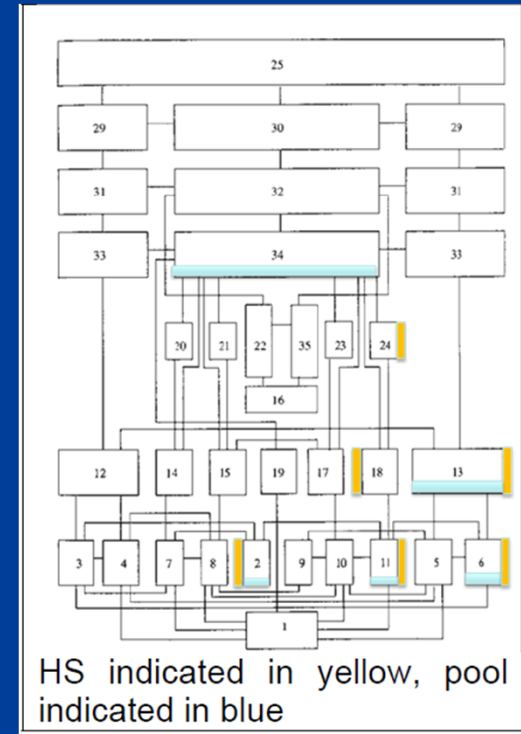
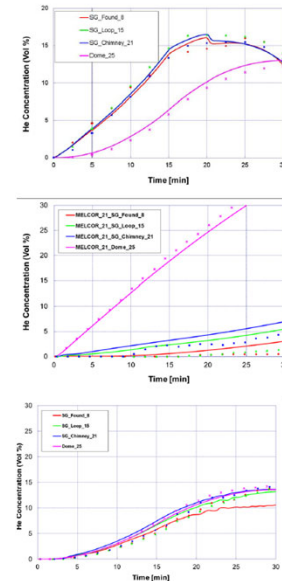

- Preliminary heat transfer coefficients (dome) were calculated to be a natural convective coefficient of  $\sim 3\text{--}5 \text{ W/m}^2/\text{K}$ . However, spreadsheet calculations performed assuming forced convection at 14 m/s (local external air velocities) suggested the HTC would be  $\sim 25 \text{ W/m}^2/\text{K}$ , or approximately five times the maximum natural convective value.
- MELCOR does not include a modeling option to augment the heat transfer coefficient for a user-specified forced flow condition. Assuming heat and mass transfer were equally affected, scale multipliers that increased the heat and mass transfer coefficient by a factor of five were added to the dome heat structure htc.

# Properly Modeling Boundary Conditions Fuel bundle experiments

- Modeling structures for which there are no components.
  - When CORA-13 was originally modelled, there was no equivalent shroud component for a PWR reactor type – note, modeling with a HS was inadequate as a HS cannot oxidize.
    - Consequently, CORA-13 was simulated as a BWR
    - Canister component was used in modeling the outer shroud
    - Sensitivity coefficients were used to redefine the split between CB adjacent to blade to CN not adjacent to blade
    - Sensitivity coefficients were used to modifying the candling closure modeling for CN
    - BWR support is now in the bypass region.
  - The PWR reactor type now permits modeling a shroud (SH) component.
    - Conduction to shroud
- Lower Head
  - The lower head does not exist in any fuel bundle experiments.
  - Structure is frequently used to model lower vessel wall, support structures, or other lower structure.
  - Failure modeling is pre-empted.

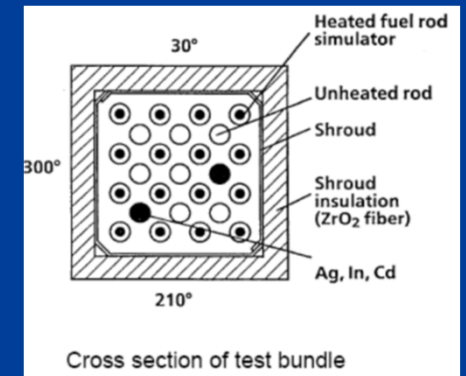
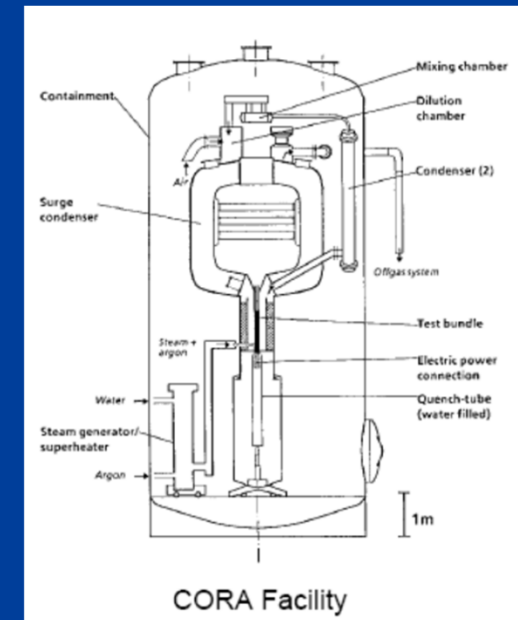
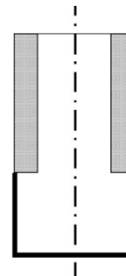
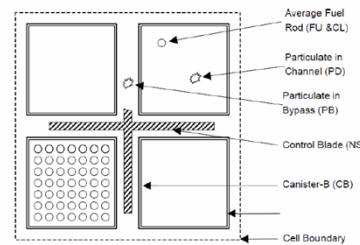

Hagen, S., et al., Results of SFD Experiment CORA-13 (OECD International Standard Problem 31) KfK 5054, February 1993.

# CORE Radiation Modeling



## Plant Modeling

### **COR\_RF** – Radiative Exchange Factors

Optional.

This record specifies the radiative exchange factors used to model thermal radiation in the core. These exchange factors roughly correspond to the traditional view factors describing the geometric orientation between two pairs of surfaces. This record is not required but, if included, from one to five fields must be present. Each value must be a nonnegative real number less than or equal to 1.0. For more details on the interpretation given to these parameters, see the COR Package Reference Manual, Section 2.1.3.

#### (1) FCNCL

Radiative exchange factor for radiation from the canister wall to the fuel rod cladding. A value must be entered for PWRs but it is not used.

(type = real, default = 0.25, units = none)

#### (2) FSSCN

Radiative exchange factor for radiation from NS (e.g., control blades) to the adjacent canister walls or to fuel rods and debris if canister is not present.

(type = real, default = 0.25, units = none)

#### (3) FCELR

Radiative exchange factor for radiation radially outward from the cell boundary to the next adjacent cell. Alternatively, the word 'MODEL' can be input and MELCOR calculates the value based on an internal model.

(type = real or character\*7, default = 0.1, units = none)

#### (4) FCELA

Radiative exchange factor for radiation axially upward from the cell boundary to the next adjacent cell.

(type = real, default = 0.1, units = none)

#### (5) FLPUP

Radiative exchange factor for radiation from the liquid pool to the core components.

(type = real, default = 0.25, units = none)

## • Small Scale Test Modeling

- The default radiative exchange factor modeling for radiation between COR cells may be adequate for a large plant model. However, for small bundle tests, radiation between the bundle elements and the boundary structures plays an important and sensitive modeling issue that deserves closer attention.

- In particular, radiation from inner rings, through outer rings, to the outer boundary may be significant.
  - Requires additional user-defined radiant heat transfer paths

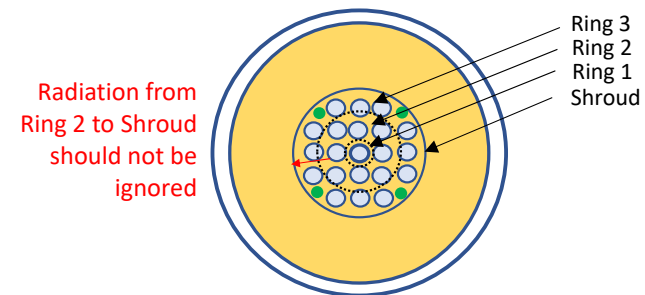

### *COR\_HTR 32*

```
1 3 2 CL 3 3 SH RADIATE-CONST 8.655E-03
2 4 2 CL 4 3 SH RADIATE-CONST 8.655E-03
3 5 2 CL 5 3 SH RADIATE-CONST 8.655E-03
```

# Electric Heater Element Modeling



- Electrical Heater Elements are frequently used to simulate nuclear heat generation in fuel rods
  - Voltage across bundle and resistance of fuel rods determines power generation
  - Local resistivity dependent on local temperature.
  - Temperature feedback determines the power distribution in the bundle
- MELCOR modeling
  - Historically, users would model with a specially compiled MELCOR executable
  - With the release of MELCOR 2.0, an internal model was available not requiring special compilation.
    - Parameters were specified by input.
    - Model was severely limited since it was specifically based on one particular experiment.
    - Did not allow more than 2 rings for heater elements
  - New model uses a high level control function that leverages ranges and vector control functions.
    - User specifies a range of COR cells and power functions for each ring in that range.
    - Allows multiple materials for elements (W, Cu, Mo)
    - Allows specification of electric losses external to elements
    - HTML expanded to include electrical heating element
      - resistivity as a function of temperature.
      - Video of temperature evolution.

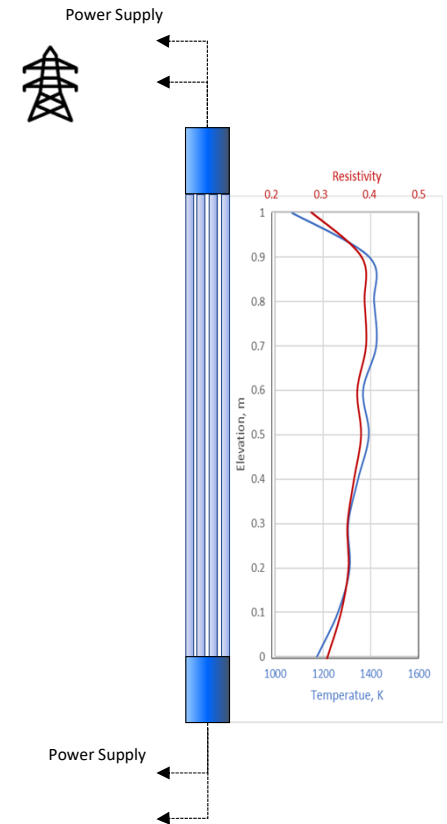

# Example of Input for ELHEAT Control Function



In the following example we have defined a range of cells, RODS, which encompasses 22 axial levels and 3 rings. For each ring we have defined a CF that specifies that the ring power is obtained from the vector CF 'RingPow' (which has 3 elements for 3 rings and pulls from the previously defined EDF files) and the contact resistance which comes from the vector control function (3 elements for 3 rings) ConRes, which specifies a 0.0 contact resistance in this case.

Resistance calculated in ELHEAT control function.

$$R_{Ring\ j} = \sum_{i, Ring\ j\ cells}^{NAXL} R_{i,j} = \sum_{i, Ring\ j\ cells}^{NAXL} \frac{\rho_{i,j}}{Area_{i,j}} dz_i = \sum_{i, Ring\ j\ cells}^{NAXL} \rho_{i,j} XLBYA_{i,j}$$

X-sectional Area, Area<sub>i,j</sub> is calculated implicitly from material masses and mass densities.

$$Area = Mass(Heater\_Material)/RHOM(Heater\_Material)/DZ(IA)$$

- CF\_ID 'Qheater' 4016 ELHEAT
  - CF\_SAI 1.0 0.0
  - CF\_VCF #RODS
  - CF\_ARG 2
    - 1 CF-VALU(RingPOW) 1.0 0.0
    - 2 CF-VALU(ConRes) 1.0 0.0
- CF\_ID 'RingPOW' 4014 EQUALS
  - CF\_SAI 1.0 0.0
  - CF\_VCF 3
  - CF\_ARG 3
  - !Power applied to each ring with electrical heaters (defined for 3 rings in Range RODS)
    - 1 EDF('EDF20',3) 1.0 0.0
    - 2 EDF('EDF20',1) 1.0 0.0
    - 3 EDF('EDF20',2) 1.0 0.0
- CF\_ID 'ConRes' 4015 EQUALS
  - CF\_SAI 1.0 0.0
  - CF\_VCF 3
  - CF\_ARG 3
  - !Resistance for each ring with electrical heaters (defined for 3 rings in Range RODS)
    - 1 CF-CONST 0.000
    - 2 CF-CONST 0.000
    - 3 CF-CONST 0.000
- ! Range covering RODS
- CF\_RANGE RODS CELLS 1000
- CONSTRUCT 3
  - 1 1-22 1
  - 2 1-22 2
  - 3 1-22 3



# COR Structure Failure Considerations



Failure of components leads to dramatic changes in thermal and reactive behavior of components as surface areas may change as well as the location and ambient conditions for materials. It is important to recognize that the failure models in MELCOR are adequate for large scale plant applications as they tend to capture the bulk behavior of large groups of rods but they do not necessarily represent the detailed mechanical response of individual components. Hence, if the experiment is intended to capture other effects, such as oxidation, it is better to be a little more heavy-handed in forcing failure to correspond to the timing observed in the experiment so that other physics can be better represented.

## 1131 – Molten Material Holdup Parameters

These coefficients are used to define conditions for which molten material is held up by a shell of primary material oxide.

(2) Maximum ZrO<sub>2</sub> temperature permitted to hold up molten materials in CL.

(default = 2400.0, units = K, equiv = TZXXM)

(4) Maximum steel oxide temperature permitted to hold up molten materials.

(default = 1700.0, units = K, equiv = TSXXM)

(6) Maximum ZrO<sub>2</sub> temperature permitted to hold up molten Zr in CN, CB, SH, SS, FM, and NS components .

## 1132 – Core Component Failure Parameters

These coefficients define the temperatures used in extended failure criteria for fuel after the Zr has melted and candled.

(1) Temperature to which oxidized fuel rods can stand in the absence of unoxidized Zr in the cladding.

(default = 2500.0, units = K, equiv = TRDFAI)

## COR\_SC 2

1 1132 2800.0 1

2 1131 2400.0 6 ! allow Zr shroud to stand to 2400 K



# COR Package Considerations - Numerics



- Scale of test section should be considered in defining what a numerically insignificant mass should be. The default value of  $1.0E-6$  for the throw away mass should likely be reduced for an experiment which may be 1000 times smaller. Similarly, the maximum temperature change criterion should be applied to smaller masses to ensure adequate numerics.

Huge Differences in Scale

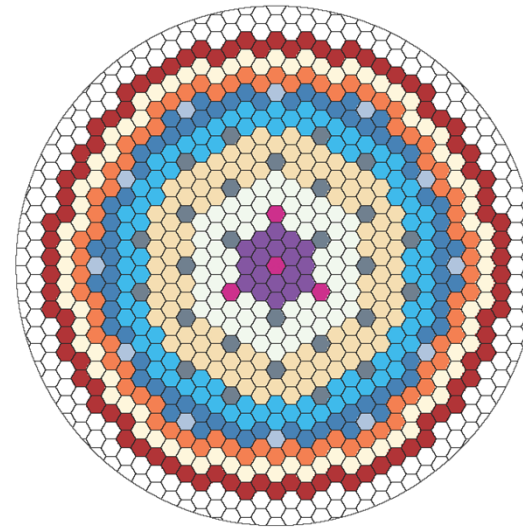

Reactor Core

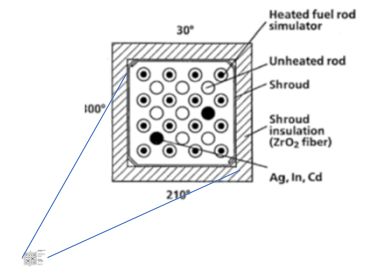

CORA-13

Hagen, S., et al., Results of SFD Experiment CORA-13 (OECD International Standard Problem 31) KfK 5054, February 1993.

## COR\_SC 2

1	1502	$1.0E-10$	1
2	1502	$1.0E-3$	2

### 1502 – Minimum Component Masses

These coefficients specify the minimum component mass below which the masses and energies are discarded and the minimum component mass below which the component is not subject to the maximum temperature change criterion.

(1) Minimum total mass of component.

(default =  $1.0E-6$ , units = kg, equiv = XMCMN1)

(2) Minimum total mass of component subject to the maximum temperature change criterion for timestep control.

(default = 10.0, units = kg, equiv = XMCMN2)

# Fission Power Absorption



- In-pile experiments require simulation of fission power and deposition of fission product energy in non-fuel components
  - Absorption in small geometry experiments might be expected to behave differently than plant geometries.
  - Could affect predicted temperatures in non-fuel components.
- 

```
PHEBUS FPT-1
COR_SC 1
1 1312 0.9500 1
```

## **1312** – Component Fission Power Absorption Parameters

These coefficients define the fraction of fission power that escapes the fuel component and determine which of the various COR components (2 through 6) absorb this available fission power, based on the relative absorption efficiencies in array 1311. The fraction of fission power that escapes the fuel component is given by the quantity  $[1 - \text{POWFAC}(1)]$ . If  $\text{POWFAC}(1) = 1.0$ , all fission power is absorbed by the fuel, regardless of the material efficiencies specified in sensitivity coefficient array 1311.

## **1311** – Material Fission Power Absorption Efficiencies

These coefficients specify the relative absorption efficiencies of fission power by the core materials. The lumping of materials (Zr with ZrO<sub>2</sub>, steel with steel oxide, and Inconel with Zr) used in previous versions of MELCOR has been eliminated. The coefficients are used in conjunction with coefficients in array C1312 to distribute the fraction  $1.0 - \text{C1312}(1)$  of the fission power that escapes the UO<sub>2</sub> fuel component (i.e., gammas) and are applied only to materials in active components, as defined by the remainder of sensitivity coefficient array C1312. User-defined COR materials can also be attributed with a fission power absorption efficiency that is zero by default.

# COR Package Considerations - Oxidation



- Experiments investigating oxidation with new materials require that the user reconsider the minimum oxidation cutoff temperature. This number was selected for traditional LWR applications and the default value was based on numerical considerations and typical accident scenarios. For new materials or experiments conducted at lower temperatures for extended periods of time, this value may need to be reduced.

COR\_SC 2

1 1004 600.0 1

---

## COR\_GOX – Generic oxidation model for chromium input

MATOX

Metal to be oxidized: i.e., ZR

GASOX

The oxidant to be used: i.e., STEAM

OXIDE

The oxide associated with MATOX (i.e., ZrO<sub>2</sub>)

TMIN = 1100 K

TMAX = 9900 K

## COR\_GOXPAR - GOM parameters for first reaction

## COR\_GOXDB – Oxidation rate parameters for the first reaction

### 1004 – Oxidation Cutoff Temperatures

These coefficients are used to prevent Zircaloy and steel oxidation below or above certain temperatures. The lower cutoff temperature prevents oxidation at temperatures that generate only minute quantities of noncondensable gases. The upper cutoff temperature can be used to limit the amount of oxidation for sensitivity analyses.

(1) Minimum oxidation temperature.

(default = 1100.0, units = K, equiv = TOXMIN)

# RN Package Considerations – Sectional Parameters



- Of the sectional parameters that the user provides on RN1\_ASP, the nominal aerosol density is perhaps the most important. The current MELCOR aerosol physics model is limited in that it permits only a single value for aerosol particles. The default value is characteristic of water droplets and for LWR applications in wet atmospheres, this is entirely appropriate. For aerosol experiments and for non-LWR applications, the user should use a value that is characteristic of the aerosol, either the density of a single aerosol material or the average of aerosol materials if appropriate.

```
RN1_ASP 1.E-07 5.E-05 9000.0
```

---

## **RN1\_ASP** – Aerosol Sectional Parameters Optional.

This record determines the size boundaries and nominal density for the aerosol calculations. If this record is input, and if the aerosol coefficients are read in on the RN1\_ACOEF record, the values are checked to see if valid aerosol coefficients have been read in. If not, the code aborts in MELGEN. If the coefficients are calculated, the values on this record are used to perform the coefficient evaluation.

### (1) DMIN

Lower bound aerosol diameter.

(type = real, default = 0.1E-6, units = m)

### (2) DMAX

Upper bound aerosol diameter.

(type = real, default = 50.E-6, units = m)

### (3) RHONOM

Nominal density of aerosols.

(type = real, default = 1000., units = kg/m<sup>3</sup>)

# RN Package Considerations – Modeling non-default Classes



- Occasionally an experiment is performed using an aerosol that is not a default MELCOR class. In such a case, a user may take an existing class and modify its properties appropriately. As an example, the AHMED test, examining hygroscopic and non-hygroscopic aerosol behavior, was performed using NaOH as a hygroscopic test specimen and the MELCOR input modified the properties of the Cs class.

- Non-Default MELCOR input

RN1_CSC	8			
1	7120	'CS'	23.0	1
2	7120	'CS'	40.0	2
3	7136	'CS'	0.0	
4	7170	'CS'	4.2E-01	3
5	7170	'CS'	3.47	4
6	7170	'CS'	2.0	7
7	7170	'CS'	2.0	8
8	7170	'CS'	2130.0	9

## 7120 – Class Molecular Weights

Two class molecular weights are specified by these coefficients. The first value represents the molecular weight as the species exists in the fuel (typically an elemental value), which is used in the class combination model to determine the total number of moles released that are available for combination with other classes. The second value represents a compound molecular weight (if data are available) after the species reacts with a nonradioactive mass (oxygen or water) when it is released.

## 7136 – Solubility of RN Classes in Water Films

If part or all of a water film drains from a surface of a heat structure to the pool in the associated control volume, any fission products deposited on that surface are normally relocated with the water in proportion to the fraction of the film that is drained. These coefficients allow the film fission product relocation behavior to be modified by changing the fraction of fission product deposits that are assumed to be dissolved in—and, therefore, relocate with—the film.

## 7170 – Hygroscopic Aerosol Parameters

The coefficients allow the user to (1) input the water solubility of RN class materials as a linear function of temperature, (2) adjust the ionization factor for the RN material (basically the number of ions formed upon dissolving in water), and (3) input/adjust the material density of the RN class compound.

# RN Package Considerations – Conditions for Aerosol coefficients



- Aerosol coefficients are a function of pressure and temperature and are evaluated at four corners in a pressure-temperature domain and interpolated for specific conditions. This range was selected to span the domain of pressurized reactors and often aerosol experiments are performed at atmospheric conditions. Hence there is a tendency among modelers to redefine the range of this interpolation to better fit the range of the experiment.
- Although this might yield slightly improved results for the experiment representation, this assumption should be clearly described in the assessment and perhaps a sensitivity calculation using a range more representative of the application should be performed.
- Non-Default MELCOR input

RN1\_PT 90000.0 150000.0 275.0 400.0

## **RN1\_PT** – Conditions for Aerosol Coefficients Optional.

This information determines the conditions at which aerosol coefficients are evaluated. The coefficients are evaluated in MELGEN at each of the four combinations of low and high pressures and temperatures specified on this record (i.e., low-T/low-P, low-T/high-P, high-T/low-P, and high-T/high-P). A power law interpolation is then used to calculate values of the aerosol coefficients for intermediate values of pressures and temperatures calculated by the code. If the conditions are outside of the range of these coefficients, the end values are used (i.e., no extrapolation is performed).

### (1) PGAS1

Lowest gas pressure for coefficients.

(type = real, default = 1.0E5, units = Pa)

### (2) PGAS2

Highest gas pressure for coefficients.

(type = real, default = 2.0E7, units = Pa)

### (3) TGAS1

Lowest gas temperature for coefficients.

(type = real, default = 273., units = K)

### (4) TGAS2

Highest gas temperature for coefficients.

(type = real, default = 2000., units = K)

# Take Aways

- Modeling of Experiments may require special considerations
    - Scale of experiment
    - Specification of boundary conditions
    - Representation of components
  - Other changes to default modeling parameters should be made with caution
    - Clearly document such changes with solid reasoning for making such changes
  - New high level model for simulating electrical heating elements
    - Leverages vector control functions and ranges
    - Extended to arbitrary number of rings
-