

MuPix8 – Large Area Monolithic HVCMOS Pixel Detector for the Mu3e Experiment

Alena Weber^{1,2}, Heiko Augustin², Niklaus Berger³, Sebastian Dittmeier², Felix Ehrler¹, Lennart Huth², Mridula Prathapan¹, Ivan Perić¹, Rudolf Schimassek¹, André Schöning², Dirk Wiedner², Hui Zhang¹

¹Karlsruhe Institute of Technology, ²University Heidelberg, ³University Mainz

Highlights of MuPix8

- Large area: 1 x 2 cm²
- 180 nm High Voltage CMOS (HVCMOS) technology on high resistivity wafers (AMS aH18)
- 128 columns, each with 200 pixels, monolithic readout
- Fast hit scan logic
- New readout electronics with several readout modes for timewalk correction
- Efficiency greater than 99.6%

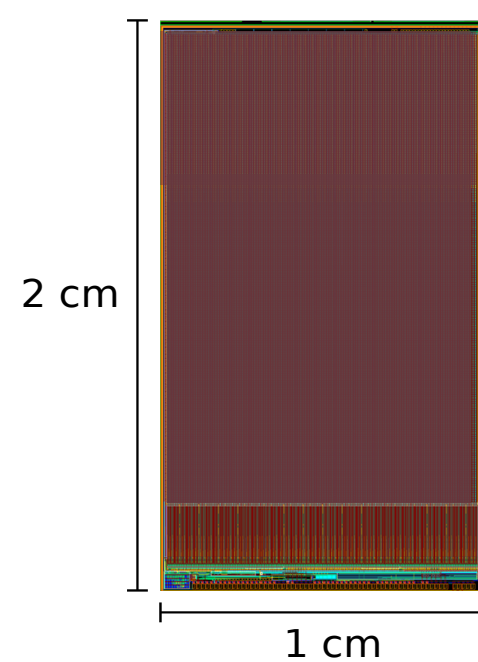

Application of the MuPix in the Mu3e experiment

- Requirements of the pixel detectors for the Mu3e experiment at PSI
 - Vertex resolution: ~100 μm
 - Time resolution: 20 ns
 - Detector thickness: max. 50 μm
- Can be achieved by HVCMOS technology

HVCMOS Technology

- CMOS monolithic pixel sensors with depleted sensitive volume
- Monolithic means the sensor and the readout electronics are integrated on a single silicon chip
- High voltage usage for fast charge collection and larger active area

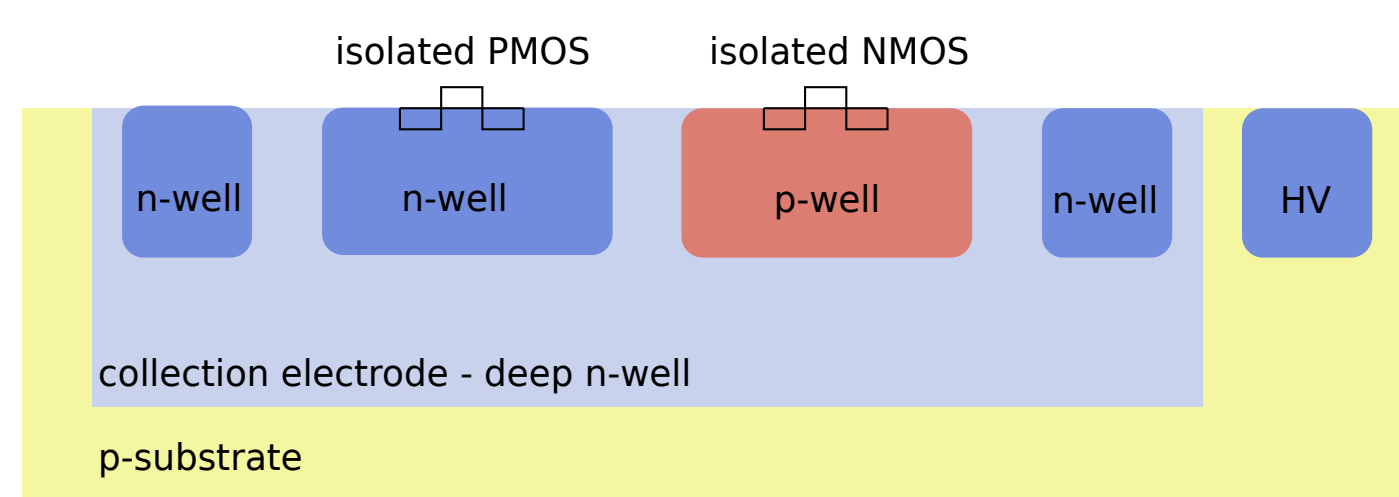

Structure of MuPix8

- The pixel matrix is divided into three submatrices with different signal transmission modes from pixel to readout
- Submatrix A uses voltage signal transmission, submatrices B and C use current signal transmission

	A	B	C
Pixels	199 ...	199 ...	199 ...
Readout	0 ... 199	0 ... 199	0 ... 199
End of column	47 ... 0 EOC	47 ... 0 EOC	31 ... 0 EOC

Fast Hit Scan Logic

- MuPix8 uses a scan logic which allows a faster search for a hit
- The scan logic works with pixel groups, if a hit is detected in a group the following groups are skipped
- This leads to a faster hit transmission to the end of column

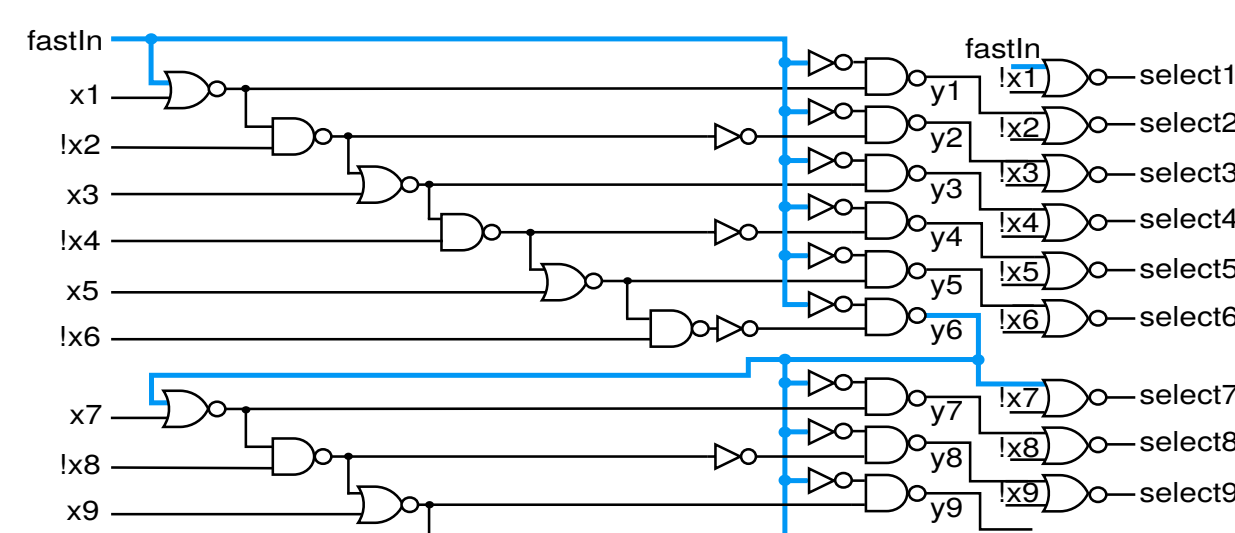
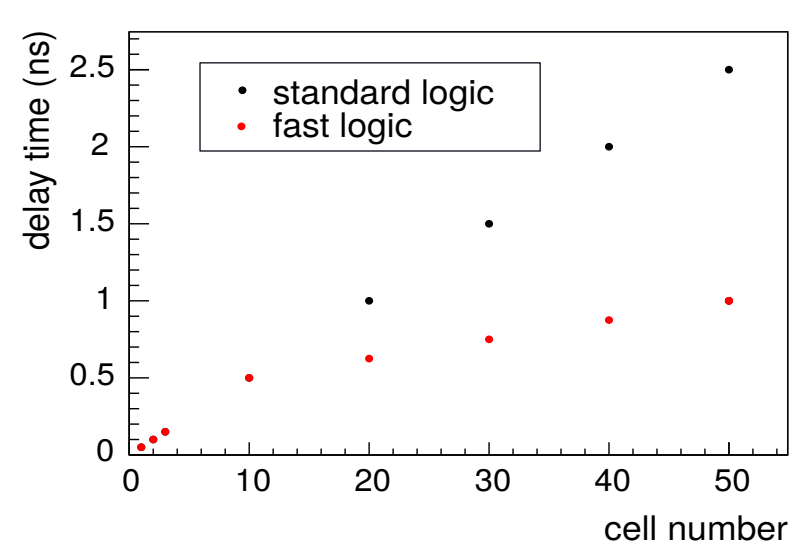

New readout electronics with several readout modes

- The MuPix8 has new readout electronics for timewalk correction
- Two comparators for each pixel are used

Timewalk Problem

- The timestamp marks when the signal crosses the threshold voltage, however there is a delay between the particle hit and the threshold crossing moment
- This delay depends on signal amplitude and is called timewalk
- The standard method for the timewalk correction is a ToT (time over threshold) measurement

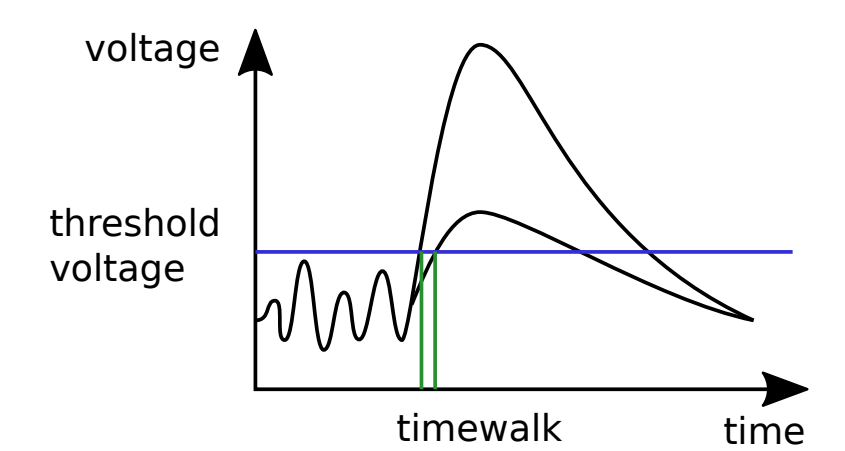

Mode with two threshold voltages

- The lower threshold voltage delivers a timestamp with less timewalk
- The higher threshold voltage confirms that the first timestamp belongs to a signal
- Advantage: less timewalk, small noise rate

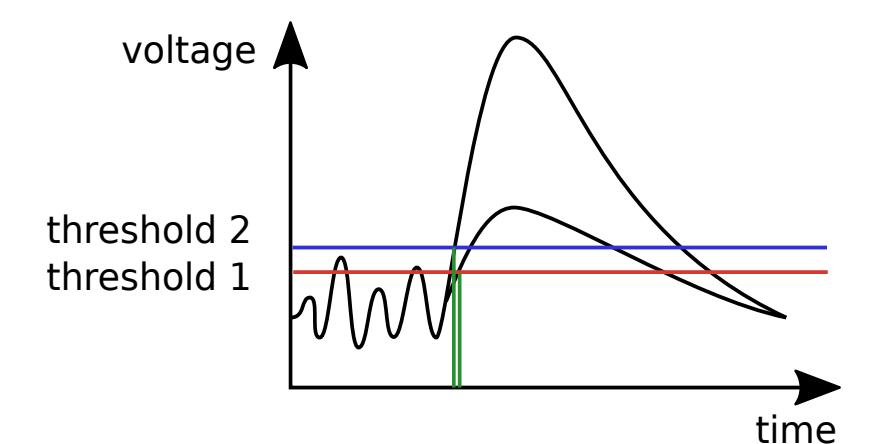

Mode with ADC threshold voltage

- The constant threshold delivers the timestamp and activates the ramp signal
- The ramp signal crosses the signal level, delivering a second timestamp for amplitude information
- Advantage: better linearity, less noise

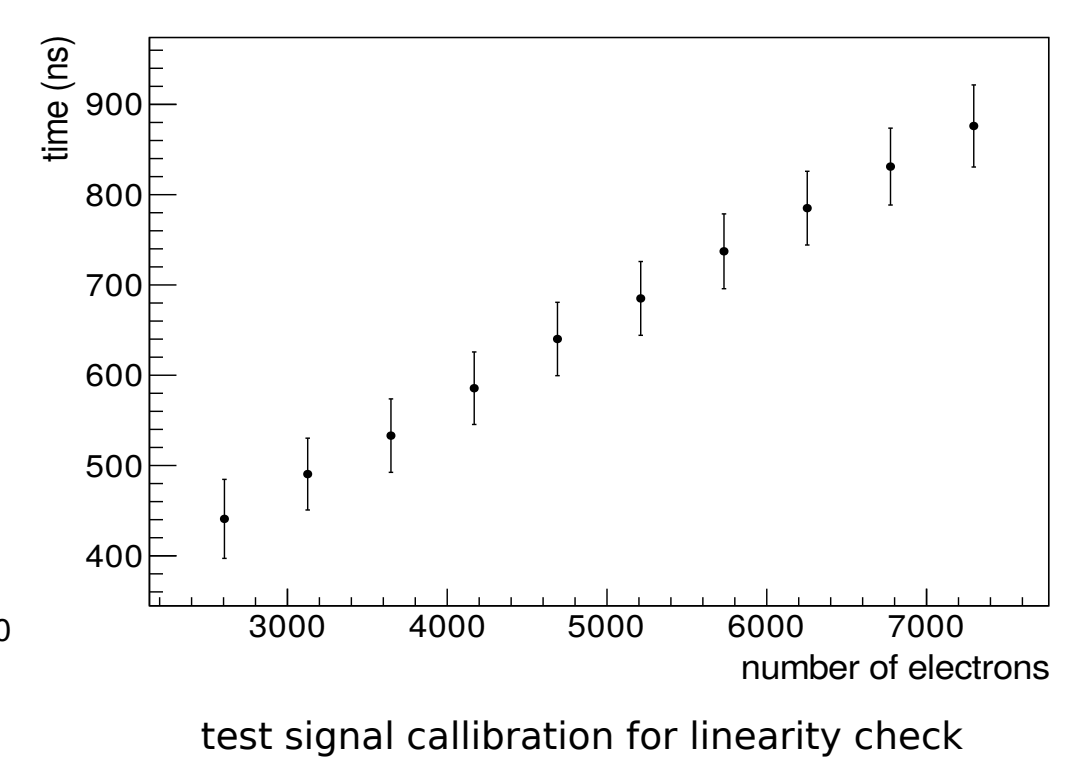
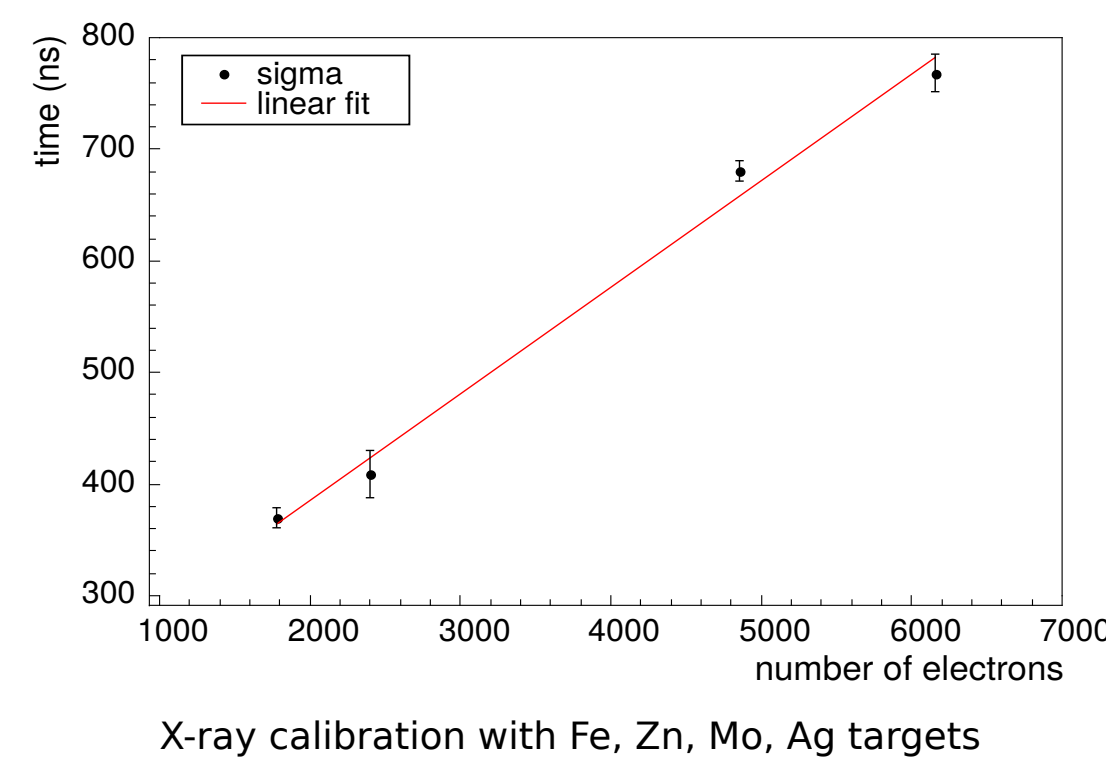
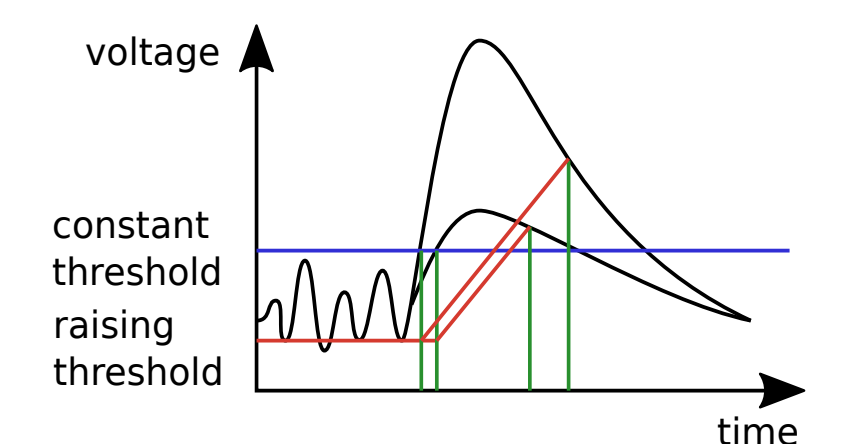

Efficiency

- In 2017, first testbeams with MuPix8 at DESY and at CERN were performed
- Results show a high efficiency > 99.6% at 125 MHz clock

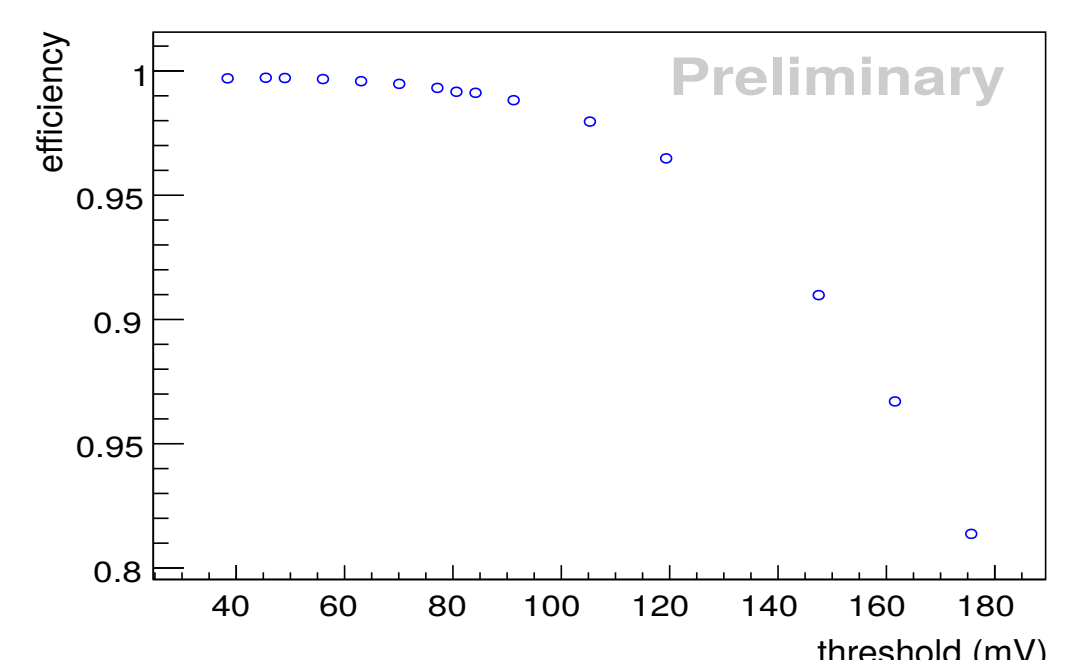
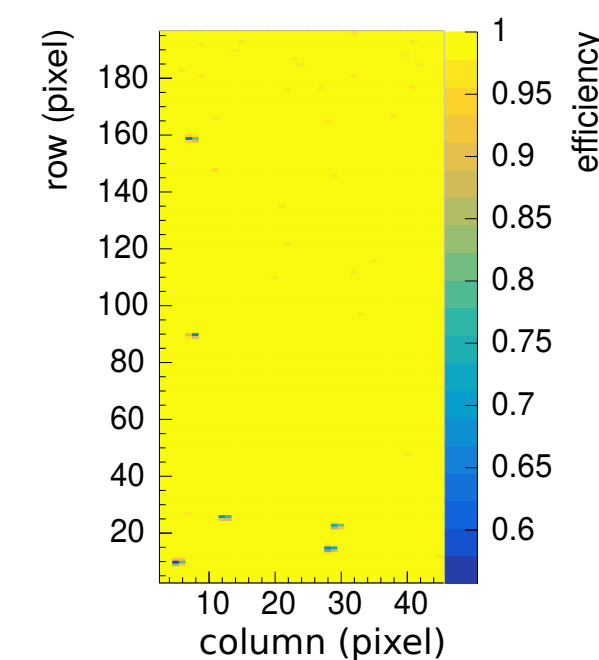

Outlook

- A new HVCMOS pixel detector (MuPix9) has been submitted in 2017 to test the following improvements:
 - New slow control
 - New power regulators, to evaluate serial powering concepts
- Design of 2 x 2 cm² chip ongoing