



Italian National Agency for New Technologies,
Energy and Sustainable Economic Development

ENEA ACTIVITIES IN THE FIELD OF SEVERE ACCIDENTS

Fulvio Mascari¹

Contributions from: D. Dongiovanni², S. Ederli³, M. Massone¹, F. Giannetti⁴, A. Bersano¹, P. Maccari⁵, G. Agnello^{1,6}, M. Angelucci⁷, M. Garbarini⁸

1 ENEA-Bologna; 2 ENEA- Frascati; 3 ENEA-CASACCIA; 4 UNIROMA1; 5 UNIBO; 6 UNIPA; 7 UNIPI; 8 POLIMI; Italy

14th European MELCOR User Group (EMUG), Ljubljana, (Slo), 12– 14 April, 2023



INTRODUCTION

- ❑ ENEA activities in the field of severe accidents by using MELCOR code is based on the analyses of current and advanced reactor designs in steady and transient conditions.

- ❑ The following activities are developed:
 - Simulation and evaluation of severe accident evolutions and source term for “safety assessment”, mainly focusing on the characteristics of NPPs located at the Italian border;
 - Code to code benchmark with other severe accident codes (e.g. ASTEC, MAAP, etc);
 - Analyses of MELCOR code capability against experimental data for current and advanced designs;
 - Coupling of MELCOR code with uncertainty tools (e.g. DAKOTA, RAVEN, etc).
 - Use of the MELCOR code for fusion technology applications.

- ❑ The activities are developed in International, European and Italian research projects:
 - European Union Research and Innovation Programme (e.g. SASPAM-SA, MUSA,..);
 - NUGENIA project (e.g. ASCOM,..);
 - IAEA CRP;
 - EUROFUSION activity;
 - Italian domestic project funded by the Ministry of Economic development;
 - Etc

- ❑ The activities are developed in collaboration with Italian Universities.

ENEA ACTIVITIES IN THE FIELD OF SEVERE ACCIDENTS BY USING MELCOR CODE

❑ [MELCOR/DAKOTA COUPLING IN A SNAP ENVIRONMENT ARCHTECTURE](#)

- Considering that currently the International Nuclear Technical Community is exploring the possibility of using severe accident code in a BEPU framework (e.g. MUSA, IAEA CRP(I31033), etc) , the target of this activity is to show the main details and capability of the MELCOR/DAKOTA coupling in a SNAP environment/architecture, and the different steps necessary to set-up it.
 - [A NUREG-IA is going to be published to investigate the MELCOR/DAKOTA coupling in a SNAP environment/architecture](#)
 - [A MELCOR/DAKOTA COUPLING group has been established in the CSARP framework to be a platform of discussion and two meetings have been already organized.](#)
- Activities are on going

❑ [EU project MUSA](#) (MANAGEMENT AND UNCERTAINTIES OF SEVERE ACCIDENTS):

- ENEA is involved in the development of a PHEBUS FPT1 uncertainty analyses by using MELCOR/DAKOTA coupling in a SNAP environment architecture and in a Python environment/architecture;
- ENEA is involved in the development of PWR-900 uncertainty analyses by using MELCOR/DAKOTA coupling in a Python environment/architecture;
- ENEA is the leader of:
 - WP4: Application of UQ Methods against Integral Experiments (AUQMIE);
 - Sub-WP3.3: Feedback integration from application of uncertainty tools;
 - Sub-WP6.3: Assessment of potential radiological consequences reduction from innovative SAM measures and systems;
 - Has coordinate the DAKOTA review and is the leader of MELCOR for the elaboration of guidelines for the use of UaSA codes/methods (WP3.2).
- The project is on going

ENEA ACTIVITIES USING MELCOR CODE

❑ Development of a Design 2 MELCOR input-deck in the frame of SASPAM-SA:

- The objective of the current input-deck is to analyze the code capability and the consequent applicability to model an integral-type reactor and to simulate the complex thermal–hydraulic phenomena occurring in a passive mitigation strategy.

❑ ENEA INVOLVMENT IN EUROFUSION: Accident analyses within EUROFusion project:

- DEMO Tokamak plant: Divertor system analyses
- DONES neutron Irradiation facility
- **Activities are on going**

❑ NUGENIA ASCOM (ASTEC COMMUNITY) Project:

ENEA is involved in the:

- WP4: ASTEC analyses at plant scale and associate crosswalk studies: **here MELCOR code is used to benchmark ASTEC code:**
 - A comparison for an unmitigated SBO has ben conducted in the 2019;
 - [A comparison for an unmitigated 2-inch Cold Leg LOCA accident has ben conducted in the 2020](#)

❑ ENEA ACTIVITIES IN THE FIELD OF SEVERE ACCIDENTS (FUSION REACTOR): activity developed in the EMUG framework:

- Analyses of the physical models necessary to be implemented in MELCOR_2.2 for fusion reactor safety analyses and the current models already implemented in MELCOR fusion
- A paper named “Current status of MELCOR 2.2. for fusion safety analyses” will be presented at the SOFT 2022 conference

ENEA ACTIVITIES IN THE FIELD OF SEVERE ACCIDENTS

□ [Development of a QUENCH-06 MELCOR input-deck:](#)

- Activity developed in the framework of IAEA CRP I31033.
- Independent user validation of Core Heat up, Zircaloy-Steam Oxidation and Degradation models embedded into best estimate MELCOR code employing the experimental dataset provided by QUENCH-06 test;
- Sensitivity analysis (SA) adopting several Zircaloy-Steam oxidation reaction rates;
- Uncertainty analysis (UA).

□ [Sensitivity analysis on MELCOR accumulators modelling:](#)

- Analysis of the available accumulators models in MELCOR simulating an unmitigated SBLOCA in a generic PWR 900 like.
- A paper will be presented at ERMSAR2022.

□ [Participation within Italian domestic project funded by the Ministry of Economic development.](#)

- In the framework of the ENEA-MSE agreement, ENEA activities related to the MELCOR code are mainly oriented to the evaluation of severe accident source term for “[safety assessment activity](#)”, mainly focusing on the characteristics of NPPs located near the Italian border.
- **The project is finished.**

ENEA PROJECT FINISHED IN THE FIELD OF SEVERE ACCIDENTS

- ❑ **EU project IVMR** (In-Vessel Melt Retention Severe Accident Management Strategy for Existing and Future NPPs):
 - ENEA has been involved in the development of a “PWR 900 like” input-deck with MELCOR code for benchmarking ASTEC code in relation to the In-Vessel Melt Retention issues during an unmitigated SBO.
 - A first calculation phase and a second phase for revised calculation have been performed.
 - **The project is finished.**

- ❑ **EU-FASTNET project** (FAST Nuclear Emergency Tools):
 - ENEA has been involved in the development of a source term database with MELCOR for selected transients.
 - **The project is finished**

- ❑ **EU project JASMIN** (Joint Advanced Severe Accidents Modelling and Integration for Sodium-Cooled Fast Neutron Reactors)
 - ENEA used the MELCOR code in order to benchmark the CPA module of ASTEC-NA.
 - **The project is finished.**
 - *A NUREG-IA based on the MELCOR calculation has been proposed; the proposal has been accepted and the NUREG-IA analyses should be based on the update code prediction obtained with the MELCOR release where the pool fire modeling have been implemented.*

- ❑ **EU-CESAM project** (Code for European Severe Accident Management):
 - ENEA has been involved in the development of a “PWR 900 like” input-deck with MELCOR code for benchmarking the ASTEC code.
 - **The project is finished.**
 - **A NUREG-IA has been published:** F. Mascari, J. C. De La Rosa Blul, M. Sangiorgi, G. Bandini, Analyses of an Unmitigated Station Blackout Transient in a Generic PWR-900 with ASTEC, MAAP and MELCOR Codes (NUREG/IA-0515), U.S. Nuclear Regulatory Commission Washington, DC 20555-0001

*THANK YOU FOR YOUR
KIND ATTENTION*

ENEA ACTIVITIES IN THE FIELD OF SEVERE ACCIDENTS – UNCERTAINTY ANALYSES

- ❑ In the evaluation of safety margins, the use of **BEPU approach** by coupling selected calculated parameters with the related uncertainty range is of great interest for the International Scientific Community.
- ❑ Considering the **reached level of development and maturity of severe accident** codes and their application on SAMG assessment, the discussion and application of severe accident progression analyses with uncertainty estimation is currently a key topic in BEPU applications.
- ❑ In the view of the research activity that are currently under development in domestic and in international framework (*e.g. MUSA project funded in the H2020 European Framework Programme, etc, IAEA CRP, etc*), ENEA have started different activities related to the uncertainty estimation:
 - Developing uncertainty analyses using the **DAKOTA software tool coupled with MELCOR code in SNAP environment/architecture**;
 - In collaboration with Sapienza University of Roma **is developing uncertainty analyses using the RAVEN software tool coupled with MELCOR code**;
 - In collaboration with University of Palermo **is developing uncertainty analysis using the DAKOTA software tool coupled with MELCOR code in a Python environment/architecture**;
 - In collaboration with University of Palermo **is developing an in-house Python based tool for developing uncertainty analysis with MELCOR**;
 - In collaboration with University of Palermo **is developing uncertainty analyses using the DAKOTA software tool coupled with TRACE code in SNAP environment/architecture** (TH activity);
 - In collaboration with IRSN and University of Bologna **is developing uncertainty analyses using RAVEN software tool coupled with ASTEC code**.
 - In collaboration with UNIPI **is developing the Python Script Stream in SNAP to manage the MELCOR runs failure**.

UNCERTAINTY ANALYSES

MELCOR/RAVEN: Analysis of the BWR FUKUSHIMA DAIICHI UNIT 1 SEVERE ACCIDENT

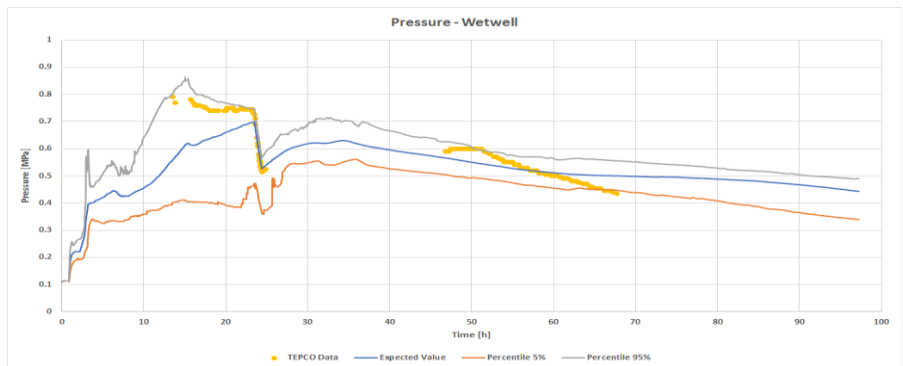
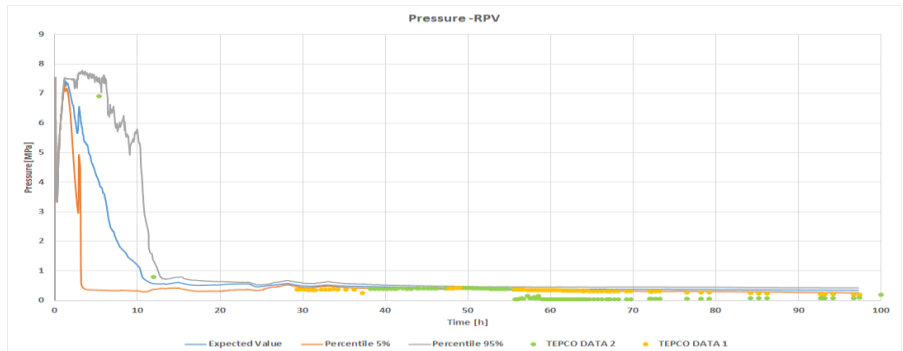
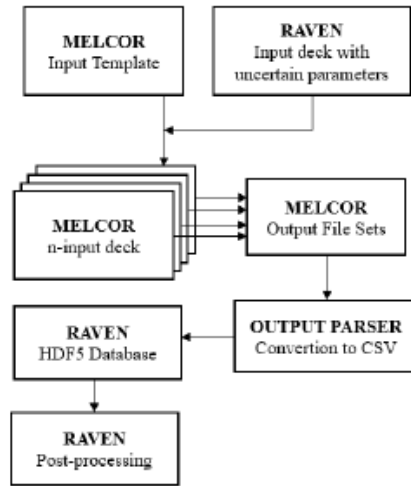

Pearson Correlation Coefficient
RPV Pressure

- RPV pressure trend, in particular in the first 6 hours after the reactor SCRAM, is strongly correlated with the seal leak area. However, in this case the trend is strongly negative, as expected.
- Other parameters under investigation in this uncertainty application (Vfall, hdblh, SC1132, SC1141, SC1502, SC1250), have a low ranked influence.

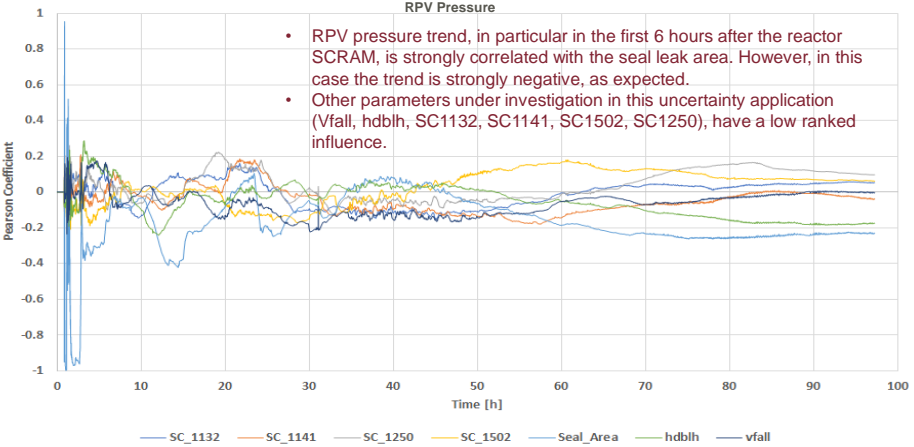

The activity has been done in collaboration with Sapienza University of Rome.

UNCERTAINTY ANALYSES

TRACE/DAKOTA: COLD LEG LBLOCA UNCERTAINTY ANALYSIS USING TRACE/DAKOTA COUPLING

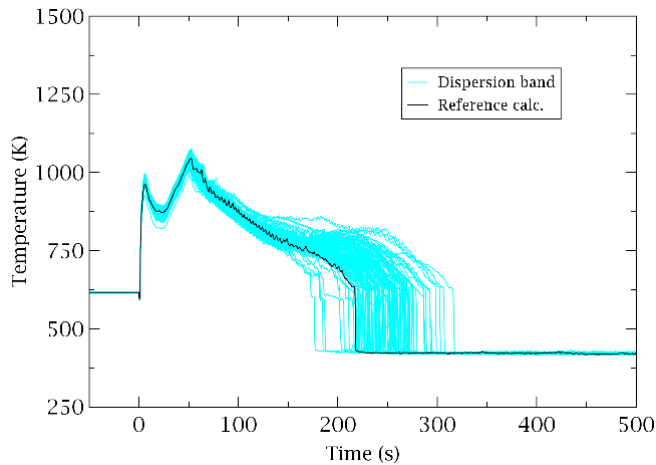

Cladding temperature of the hot rod predicted by TRACE code

Spearman rank correlation coefficient

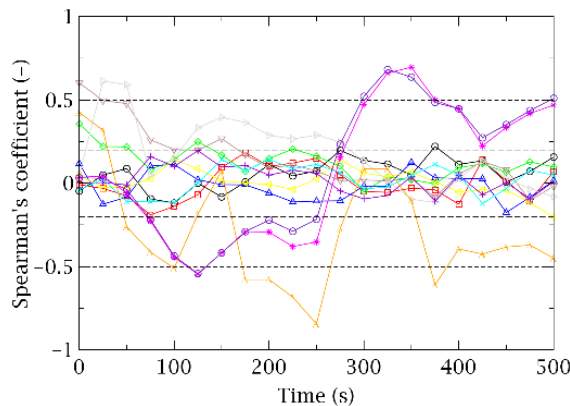

The activity has been done in collaboration with University of Palermo.

TRACE/DAKOTA: INGRESS OF COOLANT EVENT SIMULATION WITH TRACE CODE WITH ACCURACY EVALUATION AND COUPLED DAKOTA UNCERTAINTY ANALYSIS

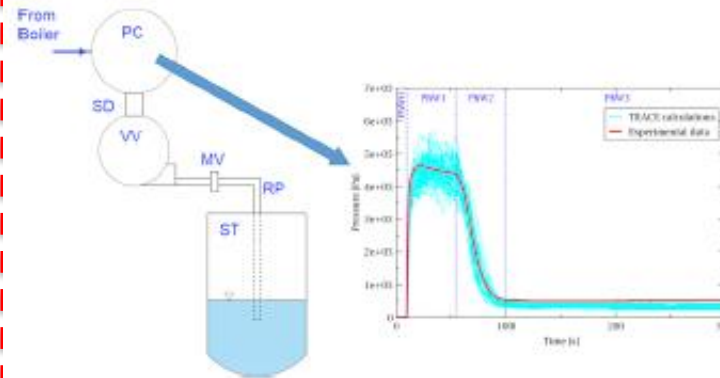

PC pressure predicted by TRACE code

Spearman rank correlation coefficient

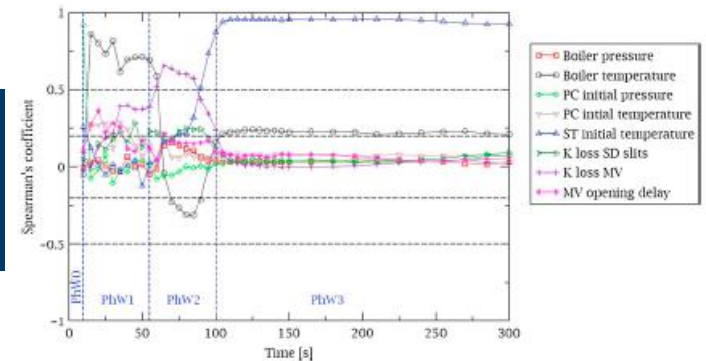

The activity has been done in collaboration with Politecnico di Torino and University of Bologna.

MELCOR – DAKOTA COUPLING FOR UNCERTAINTY ANALYSES, IN A SNAP ENVIRONMENT/ARCHITECTURE

- ❑ Considering that currently the International Community (e.g. MUSA, IAEA CRP (I31033), etc) is exploring the possibility of using SA code in a BEPU framework, the target of this activity is **to test and show the main details and capability of the MELCOR/DAKOTA coupling in a SNAP environment/architecture and the different steps necessary to set-up it.**
- ❑ A NUREG-IA, developed together with SANDIA, UNIPA and UNIFI, has been submitted for publication and has the main target of:
 - Showing the main details of the MELCOR/DAKOTA coupling in a SNAP environment/architecture;
 - Showing the different steps necessary to set it up;
 - Describing two sample applications to show the feasibility and to analyze the capabilities of this coupling (*these first exercises aiming to show only the complete application of the coupling procedure of MELCOR and DAKOTA in a SNAP environment/architecture; they do not want to represent a complete and representative analyses of the MELCOR code uncertainty*).
 - Supporting MECOR users.

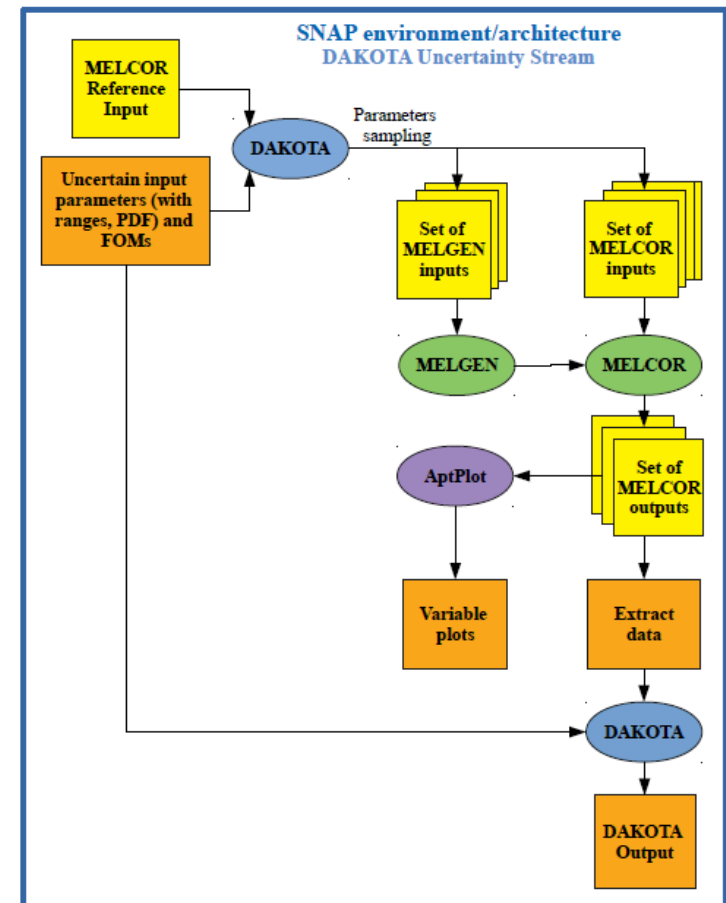

MELCOR – DAKOTA COUPLING FOR UNCERTAINTY ANALYSES, IN A SNAP ENVIRONMENT/ARCHITECTURE

MELCOR/DAKOTA: MELCOR/DAKOTA COUPLING AGAINST CSTF-AB1 test

SUSPENDED MASS

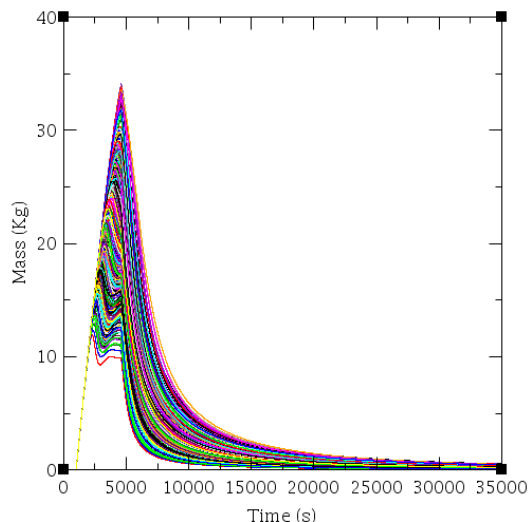

SUSP STATISTICAL ANALYSIS

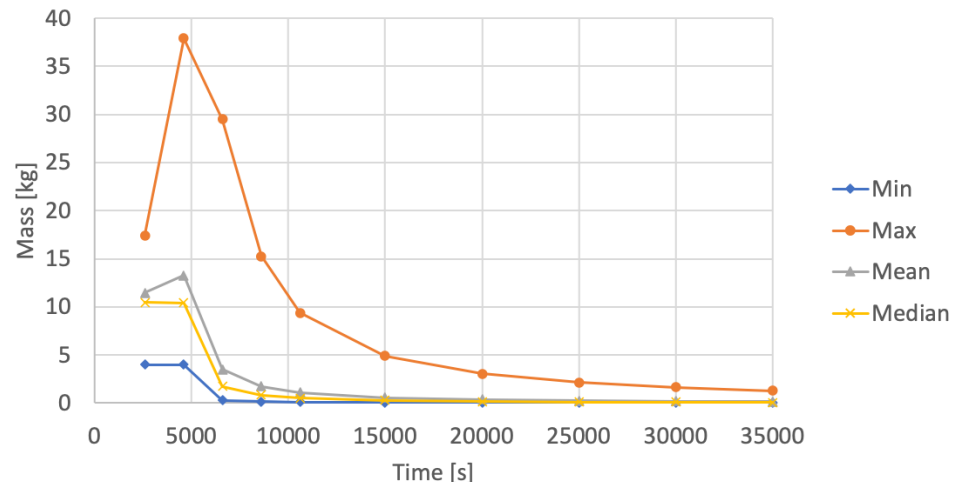

Cumulative Distribution Function

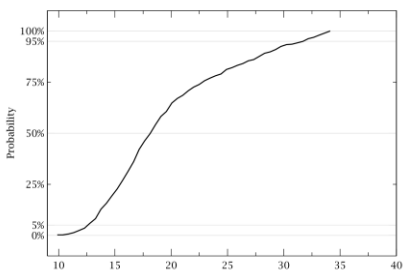

Probability Density Function

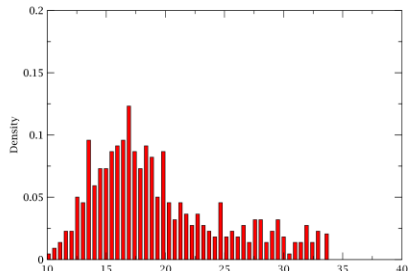

SUSP Spearman Coefficient

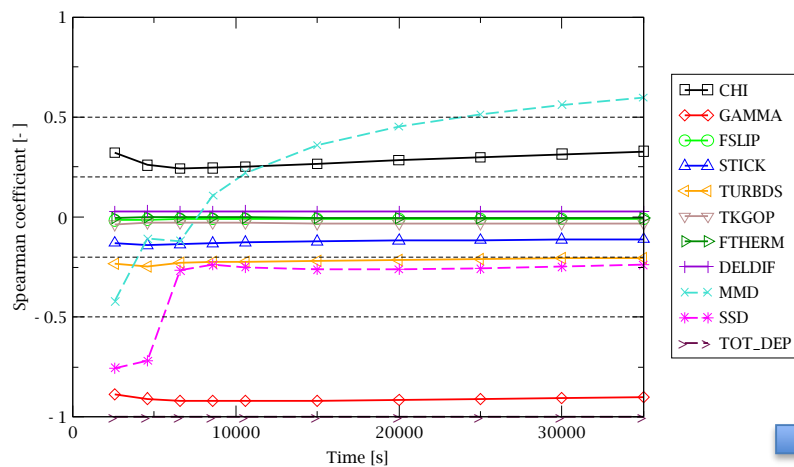

A NUREG-IA has been prepared to investigate the MELCOR/DAKOTA coupling in a SNAP environment/architecture and to be an endorsed user-guide

NUREG/IA-



International Agreement Report

MELCOR – DAKOTA Coupling for Uncertainty Analyses, in a SNAP Environment/Architecture

Prepared by:
Fulvio Mascari*, Andrea Bersano*, Giuseppe Agnello**, Michela Angelucci***, Jesse Phillips****, David Luxat*****

*ENEA, Via Martiri di Monte Sole 4, Bologna, 40129, Italy

**University of Palermo, Department of Engineering, Viale delle Scienze, Edificio 6, 90128, Palermo, Italy

***University of Pisa, Department of Civil and Industrial Engineering (DICI), Via Diotisalvi 2, Pisa Italy

****Sandia National Laboratories, 1515 Eubank SE Albuquerque, New Mexico 87123

H. Hossein, NRC Project Manager

Division full name spelled out
Office of Nuclear Regulatory Research
U.S. Nuclear Regulatory Commission
Washington, DC 20555-0001

Manuscript Completed: December 2021
Date Published: Month Year

Prepared as part of
The Agreement on Research Participation and Technical Exchange
Under the Cooperative Severe Accident Research Program (CSARP)

Published by
U.S. Nuclear Regulatory Commission

UNDER PUBLICATION

A NUREG-IA has been prepared to investigate the MELCOR/DAKOTA coupling in a SNAP environment/architecture and to be an endorsed user-guide

TABLE OF CONTENTS

ABSTRACT	iv
FOREWORD	vi
TABLE OF CONTENTS	viii
LIST OF FIGURES	x
LIST OF TABLES	xvi
EXECUTIVE SUMMARY	xviii
ACKNOWLEDGMENTS	xxiii
ABBREVIATIONS AND ACRONYMS	xxiv
1 INTRODUCTION	1
2 MELCOR/DAKOTA coupling in a SNAP environment/architecture.....	3
2.1 Propagation of Computer Code Model Input Parameter Uncertainties	3
2.2 DAKOTA toolkit	3
3 STEPS NECESSARY TO SETUP A MELCOR/DAKOTA COUPLING IN A SNAP ENVIRONMENT/ARCHITECTURE	6
3.1 Creation of DAKOTA Uncertainty Job Stream for a Two-Step MELGEN/MELCOR Stream	6
3.1.1 Selection of MELGEN and MELCOR Executable	6
3.1.2 Setting-up DAKOTA Uncertainty Analysis	13
3.2 Setting-up the Plotting Step	27
3.3 Setting-up Data Extraction Step	36
3.4 Setting-up DAKOTA Uncertainty Step	36
3.5 Execution of the Uncertainty Analysis	45
4 DAKOTA UA report	48
4.1 REPORT: Uncertainty quantification input options section	48
4.2 REPORT: Variate and Response data	48
4.3 REPORT: DAKOTA results	49
4.4 REPORT: Uncertainty analyses response correlation	49
5 MELCOR/DAKOTA COUPLING, in a SNAP environment/architecture, SAMPLES	52
5.1 SAMPLE 1: MELCOR/DAKOTA COUPLING AGAINST CSTF-AB1 test	52
5.1.1 SAMPLE 1 CASE1	52
5.1.2 SAMPLE 1 CASE1_SEN1	64
5.1.3 SAMPLE 1 CASE1 Time Dependent analysis	66

viii

5.2 SAMPLE 2: MELCOR/DAKOTA COUPLING FOR A PWR	73
6 CONCLUSION	78
REFERENCES	79
APPENDIX A	84

The activity is done in collaboration with SANDIA, UNIPA and UNIFI. A section related to the use of the use of Python directed job-stream for managing the failed calculation can be added based on the UNIFI contribution

EU-MUSA PROJECT

- ❑ **Management and Uncertainties Of Severe Accidents (MUSA)** project was founded in **HORIZON 2020 EURATOM NFRP-2018 call** on “Safety assessments to improve accident management strategies for generation II and III reactor, and it is coordinated by **CIEMAT (Spain)**.
- ❑ The project started on the 1st June 2019 and the planned duration is 48 months; the overall cost is 5.768,452.50.
- ❑ **28 Organizations from 16 Countries are involved**, and it has the NUGENIA label that recognizes the excellence of the project proposal (obtained on 7 July 2018).
- ❑ MUSA project aims to establish a harmonized approach for the analysis of uncertainties and sensitivities associated with Severe Accident (SA) analysis among EU and non-EU entities.
- ❑ **The main objective of the project is to assess the capability of SA codes when modelling Nuclear Power Plant (NPP)/ Spent Fuel Pool (SFP) accident scenarios of GEN II, GEN III designs through the:**
 - Identification of Uncertainty Quantification (UQ) methodologies to be employed, with emphasis on the effect of both existing and innovative SA Management (SAM) measures on the accident progression, particularly those measures related to the Source Term (ST) mitigation;
 - Determination of the state-of-the-art prediction capability of SA codes regarding the ST that potentially may be released to the external environment, and to the quantification of the associated code’s uncertainties applied to SA sequences in NPPs and SFPs.



EU-MUSA PROJECT

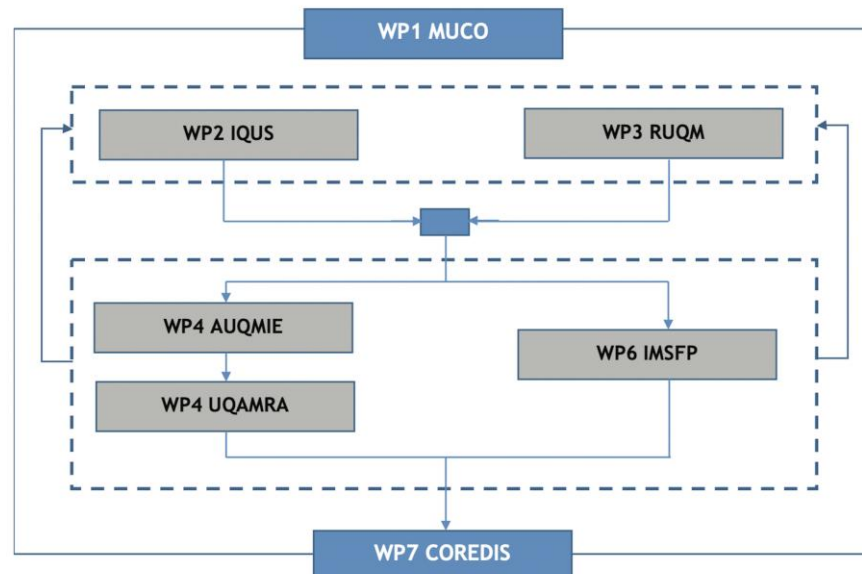
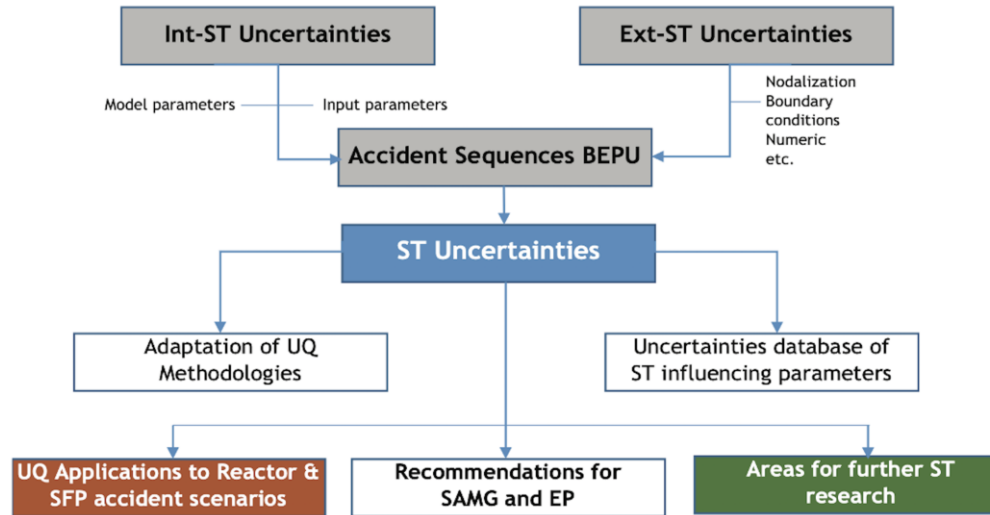

EU-MUSA PROJECT

- ❑ WP4, named AUQMIE (Application of UQ Methods against Integral Experiments), is aimed at applying and testing UQ methodologies, investigated in the WP3, lead by KIT, against the internationally recognized PHEBUS FPT1 test.
- ❑ The WP4, lead by ENEA, is divided in three main subWPs: the specification phase (WP4.1) lead by IRSN, the calculation phase (WP4.2) lead by GRS, and the analyses of the results (WP4.3), lead by UNIPI.
- ❑ Partners involved are CIEMAT, CEA, CNPRI, CNSC, CNPE, ENEA, LLC ENERGORISK, EPRI, GRS, INRNE, IRSN, KIT, LEI, NPIC, PSI, SNERDI, TRACTEBEL, SSTC NRS, TUS, UNIPI, UNIRM1, USNRC, VTT.
- ❑ This UQ application:
 - Will train the project Partners gaining experience in the Uncertainty and Sensitivity Analyses (UaSA);
 - Will also provide a platform of discussion for proposing solutions if some issues arise during the UaSA applications and
 - Will be used as a technical background for the full plant, WP5 lead by JRC, and SFP, WP6 lead by IRSN, UaSA application.
- ❑ The selection of the Figure of Merits (FOMs) of the uncertainty analyses (e.g., release of iodine from the test fuel bundle, amount of suspended iodine in the containment's atmosphere, etc) and of the main uncertainty sources have been done in WP2, lead by GRS.

ENEA APPLICATIONS IN EU-MUSA PROJECT

- ❑ Since Italy is a member of **NRC's Cooperative Severe Accident Research Program (CSARP)**, ENEA has requested a **PHEBUS FPT1 input-deck to USNRC**. USNRC disclosed it and granted permission to ENEA to use it as a part of international collaboration on the MUSA project.
- ❑ Based on the USNRC input-deck, the SNAP model has been developed.
- ❑ The nodalization of the **Phebus FPT1** used for the following study is composed of **31 control volumes**, **29 Flow Paths** and **68 Heat Structures**.
- ❑ The **fuel bundle** is axially subdivided into **eleven control volumes**, modelled with the MELCOR CVH package. The **vertical line** above the bundle is subdivided into **three regions** corresponding to the Upper Plenum (UP), the lower vertical line and the upper vertical line.
- ❑ The **horizontal line (HL)** connecting **vertical line above the bundle and inlet of the Steam Generator (SG)** is modelled with two control volume. The SG is characterized by **9 control volumes in the ascending side** and **two control volumes** in the descending side. There is one control volume connecting the outlet of the SG to the **containment**, which is modeled with **one control volume**.
- ❑ The **bundle test section** is modelled, in the **COR package**, by **31 axial regions** and **2 radial regions**.

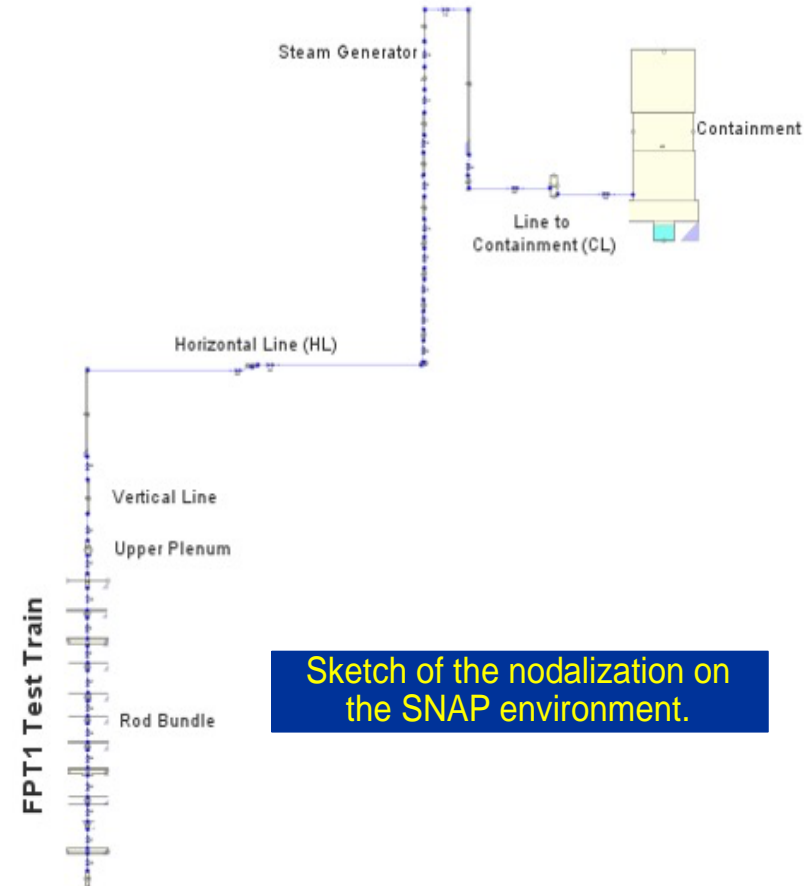

Sketch of the nodalization on the SNAP environment.



ENEA APPLICATIONS IN EU-MUSA PROJECT

- ▶ The following FOMs has been investigated in the reference case:
 - Release of iodine from the test fuel bundle [% of initial inventory];
 - Release of Caesium from the test fuel bundle [% of initial inventory];
 - Caesium retention in the circuit [%of Cs released from the bundle];
 - Aerosol mass in suspension in the containment's atmosphere [g];
 - Amount of suspended iodine in the containment's atmopshere [g];
 - Total deposited iodine in the containment [g].
- ▶ The calculation time is: **29500 s**.

ENEA APPLICATIONS IN EU-MUSA PROJECT

Analyses of the code accuracy to predict the MUSA-WP4 FOMs in the reference case

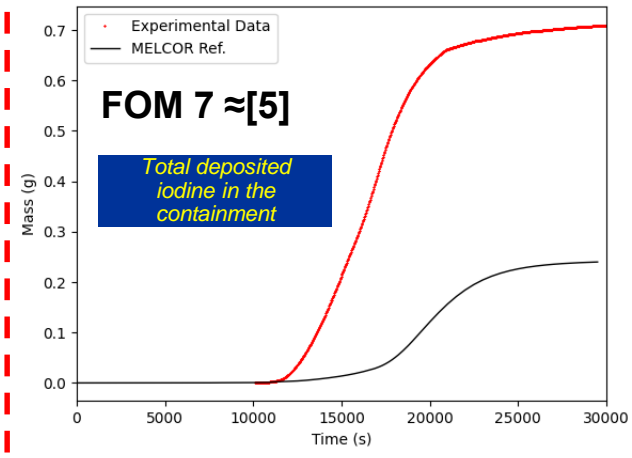
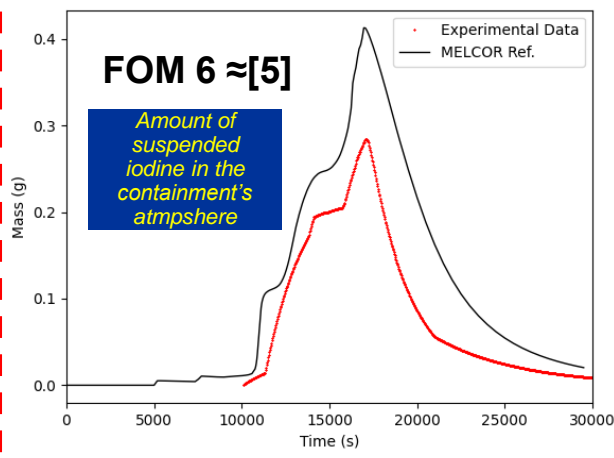
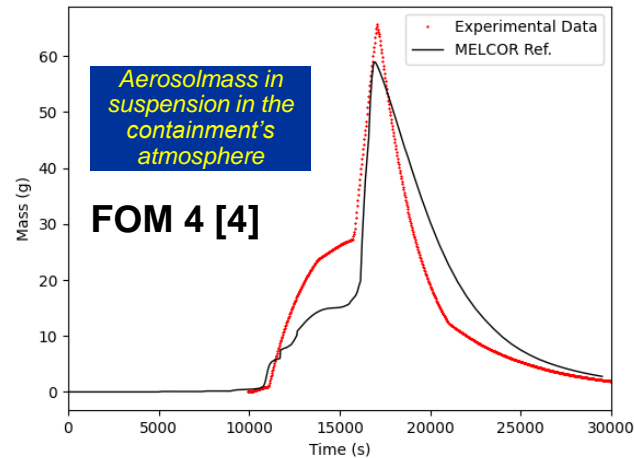
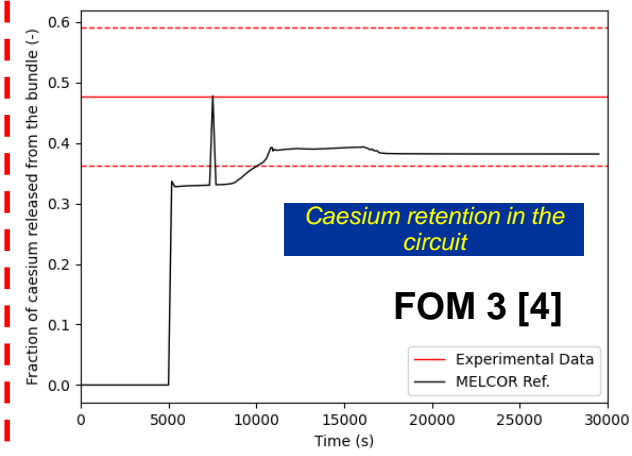
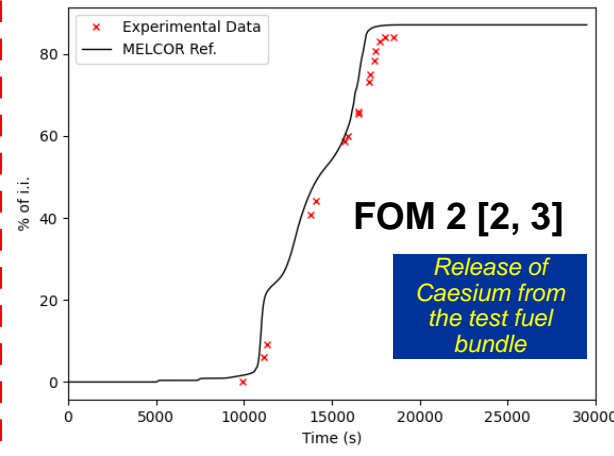
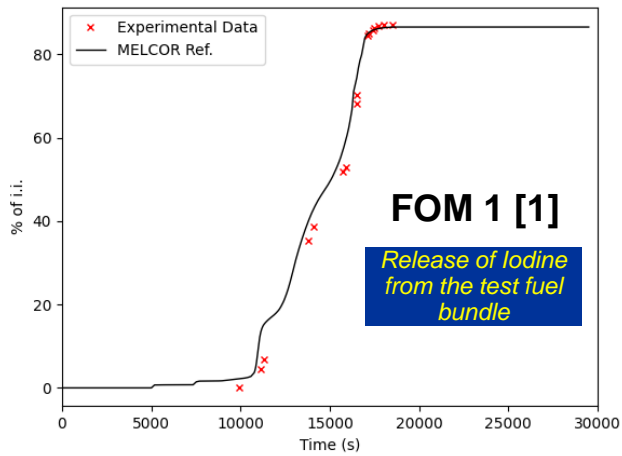

ENEA APPLICATIONS IN EU-MUSA PROJECT

- ❑ To develop the uncertainty analysis of this case, the coupling **MELCOR/DAKOTA** in **SNAP environment/architecture** has been considered.
- ❑ DAKOTA toolkit, provide as a plug-in for SNAP, allows the following:
 - Enter the uncertain input parameters (with range and PDF);
 - Select the sampling method (Monte Carlo or Latin Hypercube);
 - Enter the desired FOMs for the analysis;
 - Set the final report.
- ❑ DAKOTA is used both at the beginning of the analysis to **sample the uncertain input parameter values** and to **generate the set of code inputs**.
- ❑ Then, after the solution of the set of code inputs and the extraction of the desired data, DAKOTA performs the **uncertainty analysis** and apply **regression techniques** to evaluate the **correlation between input and output parameters selected as a FOMs**.
- ❑ At the present stage of the research activity, **there are possible failure of the DAKOTA application in SNAP if one MELCOR calculation fails**.

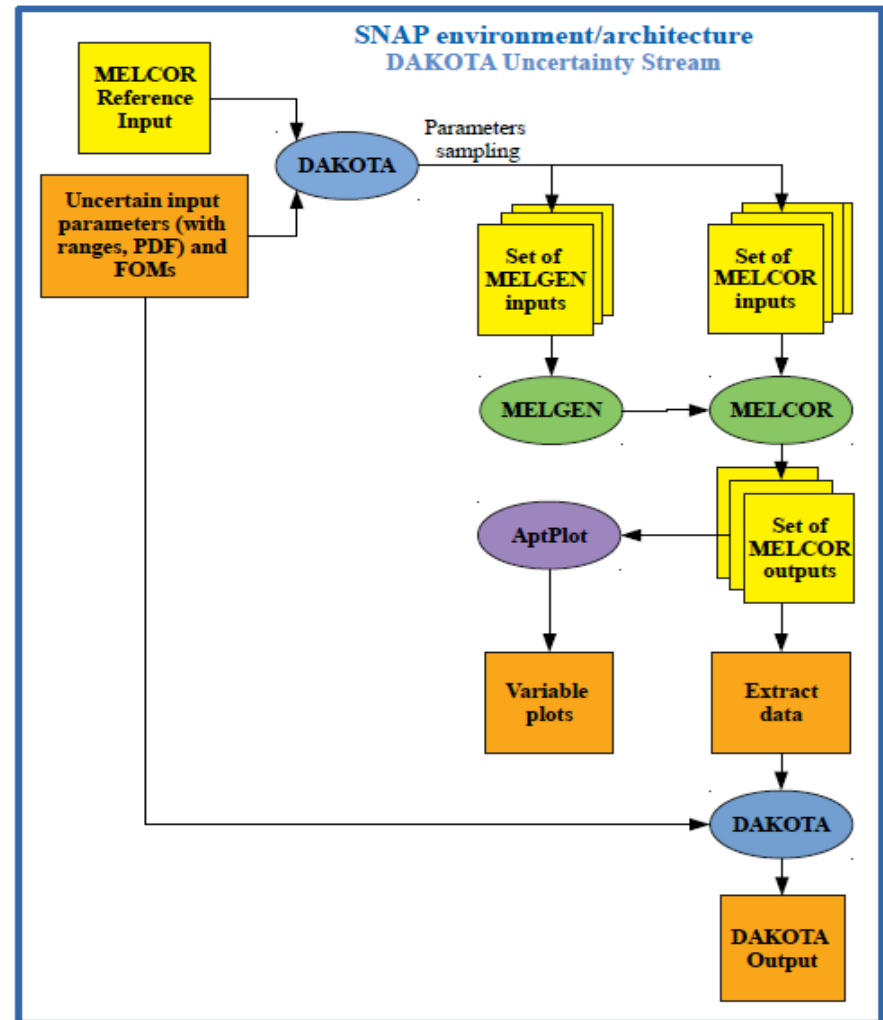

ENEA APPLICATIONS IN EU-MUSA PROJECT

- ❑ Currently if one calculation fails it prevents finalizing the UA application in SNAP:
 - o New **Python directed job-stream** capability in SNAP have been added;
 - o In the version 1.7 of the SNAP uncertainty plugin “the uncertainty quantification support in Python Directed streams was updated to support a specified number of **"Replacement Samples"** that are used to run additional tasks to replace those that fail to execute” (<https://www.applot.com/snap/plugins/uncertainty/changes.jsp>).
- ❑ The **MELCOR/DAKOTA coupling through the Python Stream in the SNAP environment/architecture** has been developed together with UNIPI in collaboration with ENEA.
- ❑ Through this coupling approach, the **management of failed code runs** is possible by the last SNAP version (3.1.6).
- ❑ This MELCOR/DAKOTA coupling is managed through a python script, elaborate by SNAP, which permits to:
 - Run the MELGEN/MELCOR runs with the different sets of input uncertain parameters, created by the DAKOTA uncertainty plug-in;
 - Calculate the FOM values for each run;
 - Plot the dispersion of the FOMs through the module “PyPost”, developed by AptPlot;
 - Generate the UQ final report.

ENEA APPLICATIONS IN EU-MUSA PROJECT

MELCOR and DAKOTA coupling through SNAP: PYTHON DIRECTED STREAM

Dakota – Variates



MELGEN



MELCOR



FOMs



Dakota –
Analysis & Report



APTLOT



Plot –
FOM vs time

The activity has been
done in collaboration
with University of Pisa.

ENEA APPLICATIONS IN EU-MUSA PROJECT

- ❑ Considering the current issues when using the MELCOR/DAKOTA coupling with the DAKOTA plug-in in SNAP for uncertainty analysis a new mixed approach through SNAP and MATLAB has been developed by UNIPI.
- ❑ **New Python Directed job-stream feature has been added in SNAP.**

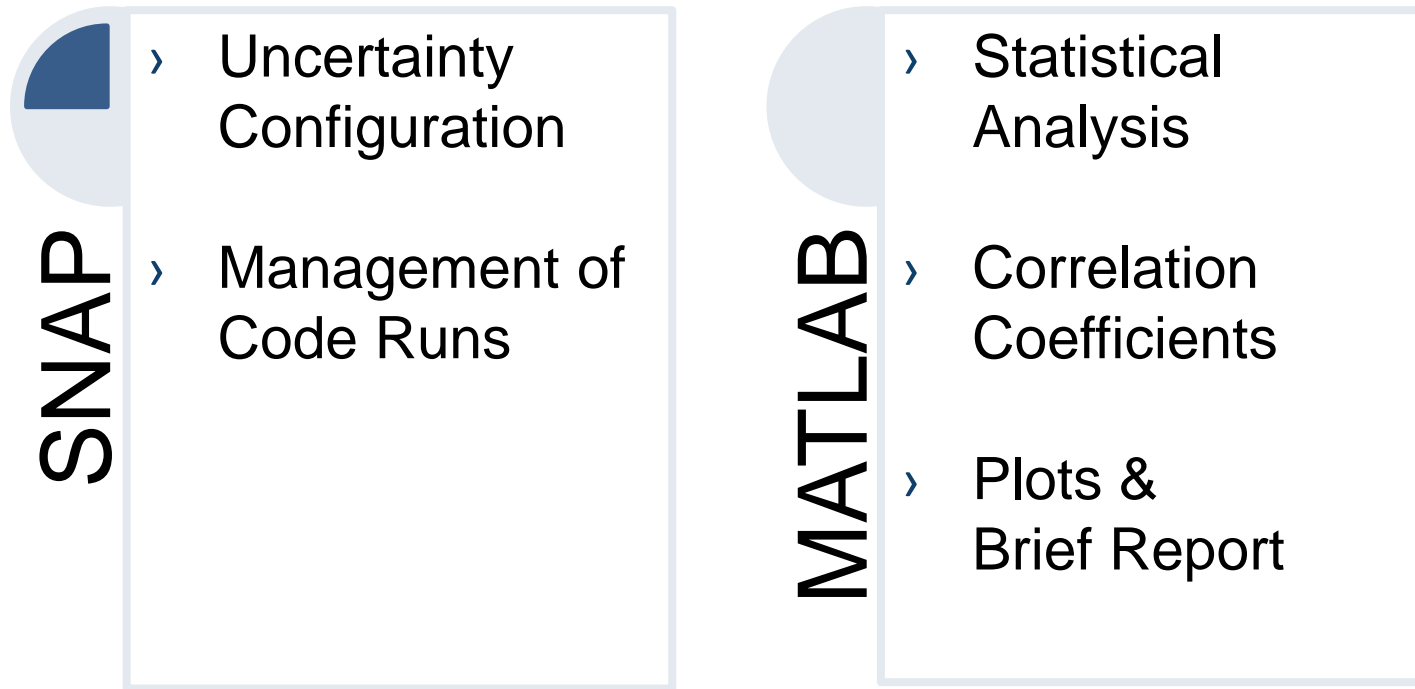

ENEA APPLICATIONS IN EU-MUSA PROJECT

SNAP

Use of DAKOTA plug-in
&
new Python Directed
Stream feature

The screenshot shows a Python script in a text editor and a DAKOTA Properties dialog box. The script imports the parametric module and sets up a stream with actors. The dialog box is titled "Edit Uncertainty Configuration" and has tabs for "DAKOTA Properties", "Variables", "Distributions", and "Report".

```
import parametric

from snap import streams
import snap.model_editor as model_editor
from snap.codes.melcor import *
from pypost.codes.melcor import *
from pypost.codes.aptpilot import *
from snap import streams

stream = streams.get_stream()

phebus = model_editor.open_model("C:\\Users\\m.angelucci13\\Desktop\\Phebus_FPT1_v5_5.med")

for i in range(0, len(parametric.get_table)):
    row = parametric.get_table(i)
    row_row_index = len(parametric.get_table()) - row_row_index

actors=[]
for row in parametric.get_table():
    row.apply_values(phebus)
    actor_name = row.new_task_name
    melgen_run = MelgenActor(stream, row_row_index, actor_name)
    actors.append(melgen_run)
    actor_name2 = row.new_task_name
    melcor_run = MelcorActor(stream, row_row_index, actor_name2)
    actors.append(melcor_run)
    #stream.add([melgen_run, melcor_run])

stream.add(actors)
```

DAKOTA Properties

Number of Samples: 93
Replacement Samples: 37
Random Seed: -auto-
Sampling Method: Monte-Carlo Latin Hypercube
Figures of Merit: Aer_Cont

Order: 1
Probability: 95.0
Confidence: 95.0
Time Dependent: ent> E

Name	Lower Limit	Upper Limit	Description
Aer_Cont	<input checked="" type="checkbox"/>	<input checked="" type="checkbox"/>	<unset>

Buttons: Help, Undo, Redo, OK, Cancel

- › Input Parameters
- › Distributions
- › Sampling
- › N° of runs
- › Parallel Computing

ENEA APPLICATIONS IN EU-MUSA PROJECT

MATLAB

Parameters related data extracted from
«parametric.py»



PARAMETERS_TABLE

	A	B	C	D	E	F	G	H
1	CHI	GAMMA	FSLIP	STICK	TURBDS	TKGOP	FTHERM	DELDIF
2	2.917758	1.384461	1.240084	0.902309	0.000832	0.00639	2.495339	5.41E-05
3	3.007051	3.043297	1.229796	0.803784	0.001171	0.054991	2.38043	0.000166
4	1.995144	3.10434	1.237184	0.937509	0.001079	0.02168	2.241081	6.77E-06
5	3.667595	1.012699	1.269932	0.930263	0.001013	0.0121	2.434387	0.000136
6	3.540712	4.087984	1.23822	0.863357	0.000803	0.009759	2.240758	0.00017
7	1.145789	3.387977	1.261731	0.979848	0.001112	0.006511	2.206781	0.000136
8	4.811028	3.050262	1.246044	0.569483	0.001169	0.00762	2.148951	0.000164
9	4.411897	1.136382	1.265689	0.814381	0.000853	0.035548	2.317295	8.17E-05
10	1.127445	1.637007	1.240215	0.703521	0.000979	0.010862	2.087603	0.000141
11	1.159056	3.560364	1.261965	0.676546	0.001031	0.050393	2.172414	0.000139
12	2.652567	1.934348	1.270717	0.608234	0.001236	0.021614	2.028366	4.34E-05
13	3.175211	3.486956	1.271715	0.565414	0.00122	0.015662	2.274189	5.42E-05
14	4.513611	3.403932	1.238271	0.907929	0.001017	0.007463	2.045325	2.51E-05
15	2.569383	1.949613	1.258938	0.981569	0.001164	0.050946	2.156422	1.82E-05
16	1.634272	3.943583	1.252372	0.859384	0.000884	0.056702	2.481325	8.18E-05
17	2.585649	2.690455	1.240403	0.783616	0.001136	0.006537	2.202507	1.03E-05

PARAMETER vs Iter.

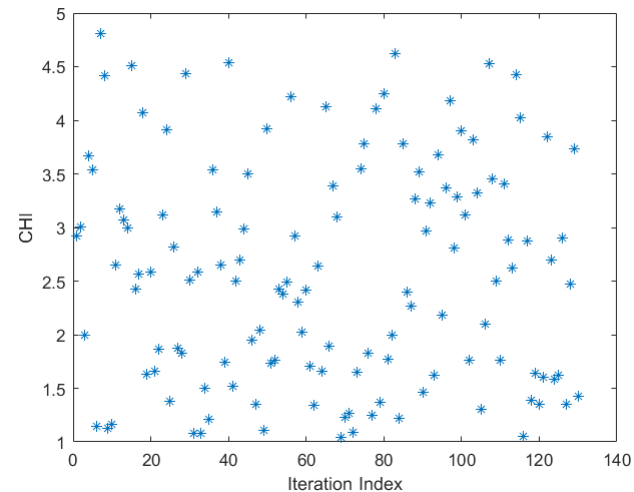

ENEA APPLICATIONS IN EU-MUSA PROJECT

MATLAB

FOM values extracted from
«FOM.txt» (EDF)



FOM_TABLE

	Z	AA	AB	AC	AD	AE	AF	AG	AH
1	0	0	0	0	0.11224	0.113325	0.111495	0.10961	0.107784
2	0	0	0	0	0.113002	0.114099	0.112257	0.110359	0.10852
3	0	0	0	0	0.102463	0.103147	0.10129	0.099393	0.097558
4	0	0	0	0	0.115934	0.117092	0.115226	0.113302	0.111438
5	0	0	0	0	0.115756	0.116898	0.115022	0.113089	0.111215
6	0	0	0	0	0.091307	0.092003	0.090389	0.088726	0.08712
7	0	0	0	0	0.119434	0.120651	0.118741	0.116773	0.114865
8	0	0	0	0	0.118123	0.11932	0.117427	0.115476	0.113585
9	0	0	0	0	0.090862	0.091583	0.090008	0.088382	0.086814
10	0	0	0	0	0.091251	0.09195	0.090337	0.088675	0.087071
11	0	0	0	0	0.111234	0.112291	0.110469	0.108592	0.106774
12	0	0	0	0	0.114025	0.115131	0.113274	0.111361	0.109507
13	0	0	0	0	0.118389	0.119567	0.117656	0.11569	0.113783
14	0	0	0	0	0.109569	0.11056	0.108734	0.106855	0.105036
15	0	0	0	0	0.100213	0.10106	0.09934	0.097569	0.095856
16	0	0	0	0	0.109008	0.109925	0.108065	0.106157	0.10431
17	0	0	0	0	0.100797	0.101616	0.099871	0.098076	0.09634



DISPERSION

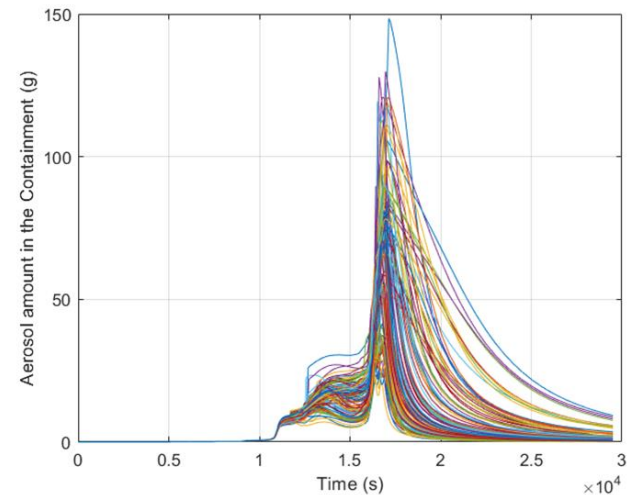

ENEA APPLICATIONS IN EU-MUSA PROJECT

MATLAB

STATISTICAL ANALYSIS

(max, min, mean, median, standard deviation, skewness, kurtosis, CDF, PDF, ...)

TIME-DEPENDENT

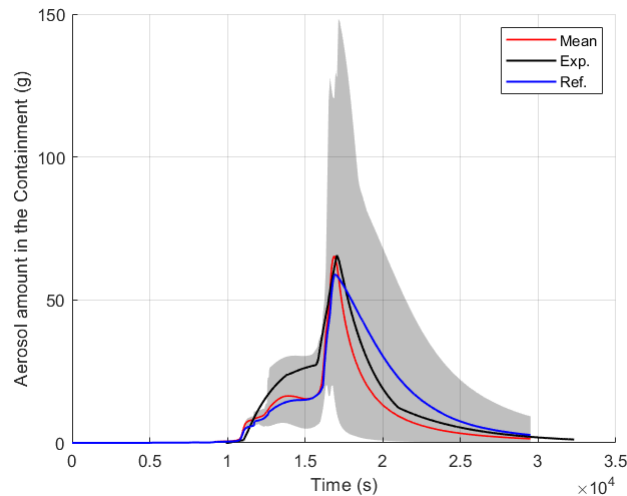

MAX_VALUE

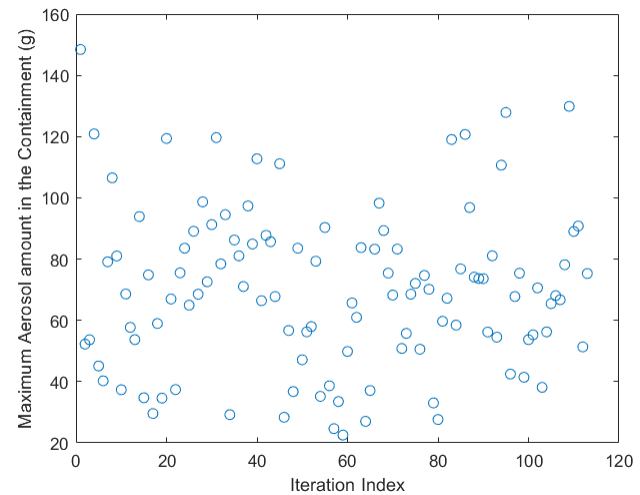

MATLAB

SENSITIVITY ANALYSIS (Pearson & Spearman coefficients)

TIME-DEPENDENT

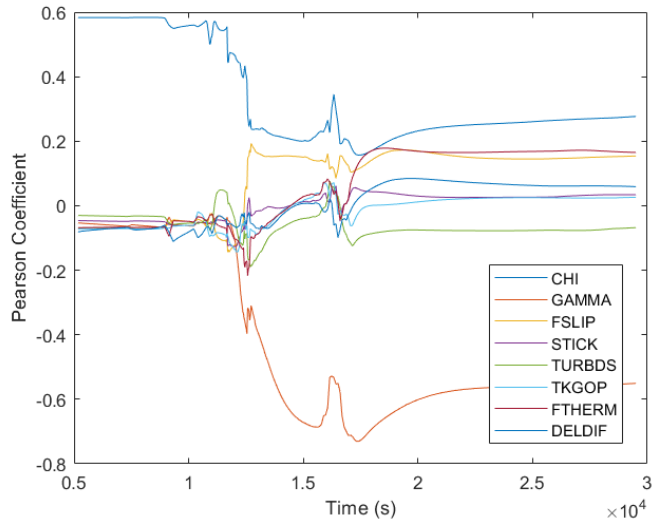

MAX_VALUE

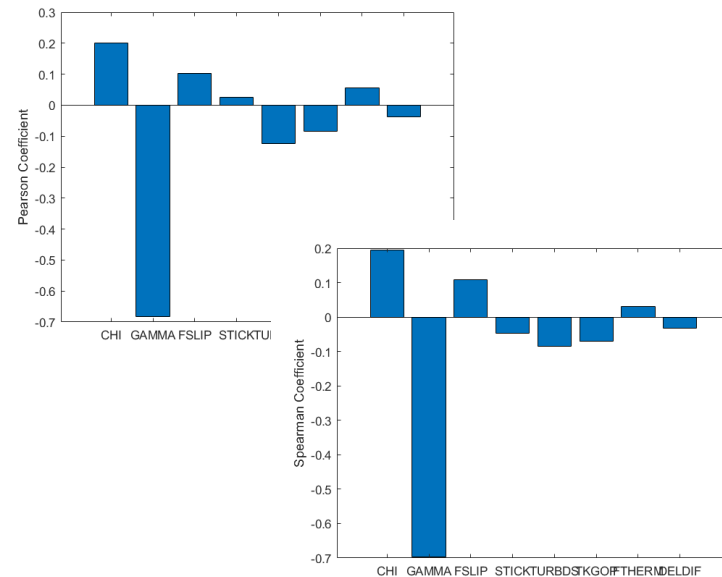

MATLAB

BRIEF REPORT

Main information about
failed runs & statistical quantities

Brief Report

number of failed runs: 17

failed runs: 13 14 16 18 26 29 36 38 39 48 49 66 84 100 104 124 126

selected FOM: maximum Aerosol amount in the Containment (g)

maximum value: 148.4348

minimum value: 22.5524

mean value: 69.8765

median value: 68.5436

standard deviation: 26.015

quantile 0.95: 119.6295

quantile 0.05: 29.2779

skewness: 0.42559

kurtosis: 2.9877

ENEA APPLICATIONS IN EU-MUSA PROJECT-

Coupling MELCOR/DAKOTA with Python Script

- ❑ Implementation of the **coupling MELCOR/DAKOTA** with **Python Script***.
- ❑ Coupling based on using the user interface **DAKOTA GUI** implemented by DAKOTA.
- ❑ Goal of this application is to resolve the issue of **failed MELCOR runs**, develop the uncertainty quantification report, and explore the full capability of **DAKOTA stand alone**.
- ❑ This approach is based on the Python scripting which permits to:
 - Run the MELCOR cases;
 - Extract the FOMs channels with AptBatch executable;
 - Plot the dispersion of FOMs channels;
 - Compute the statistical values of the FOMs (e.g. mean, median, upper and lower bounds, quantiles, ecc.) in a time-dependent approach;
 - Compute and plot the time-dependent Pearson and Spearman's coefficients;
 - Compute and plot the PDF and CDF of the FOMs.
- ❑ A dedicated presentation has been done during the EMUG22.

*A PhD student of the University of Palermo is part of this activity

ENEA APPLICATIONS IN EU-MUSA PROJECT- Coupling MELCOR/DAKOTA with Python Script

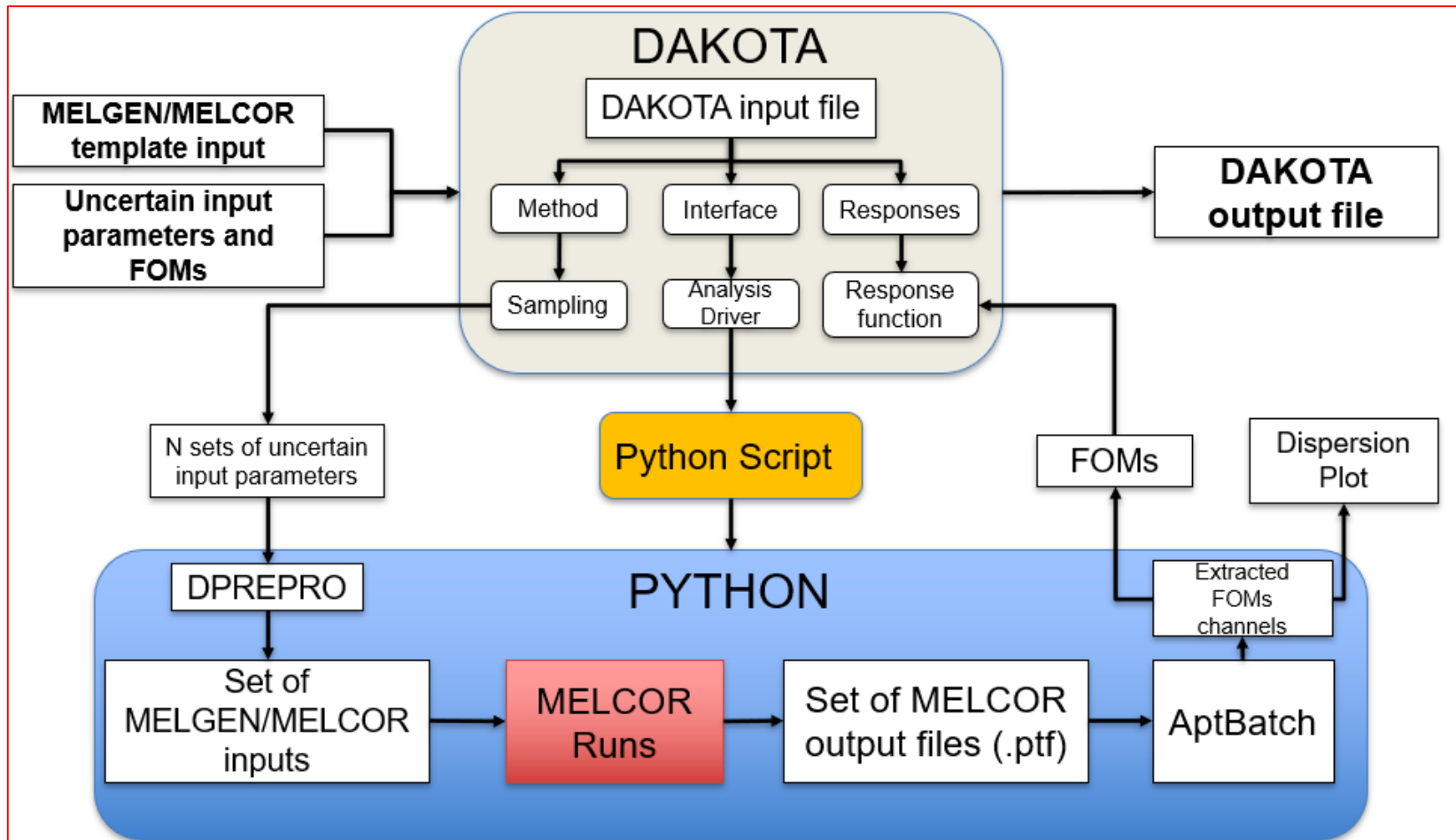

The analysis of the MELCOR and DAKOTA coupling through Python Scripts has been developed along the EU-MUSA project



ENEA APPLICATIONS IN EU-MUSA PROJECT

- ▶ The **uncertain input parameters** selected from the WP2 database for the **uncertainty analysis** currently are:
 - CHI (Aerosol dynamic shape factor)
 - GAMMA (Aerosol agglomeration shape factor)
 - FSLIP (Particle slip coefficient)
 - STICK (Particle sticking coefficient)
 - TURBDS (Turbulence dissipation rate)
 - TKGOP (Ratio of the thermal conductivity of the gas over that for the particle)
 - FTHERM (Thermal accommodation coefficient)
 - DELDIF (Diffusion boundary layer thickness).
- ▶ At the current state of the activity, the preliminary FOM selected for the uncertainty analysis is the «**Aerosol mass in suspension in the containment's atmosphere**» and in particular the statistical analysis is conducted considering the maximum value of this one.

ENEA APPLICATIONS IN EU-MUSA PROJECT

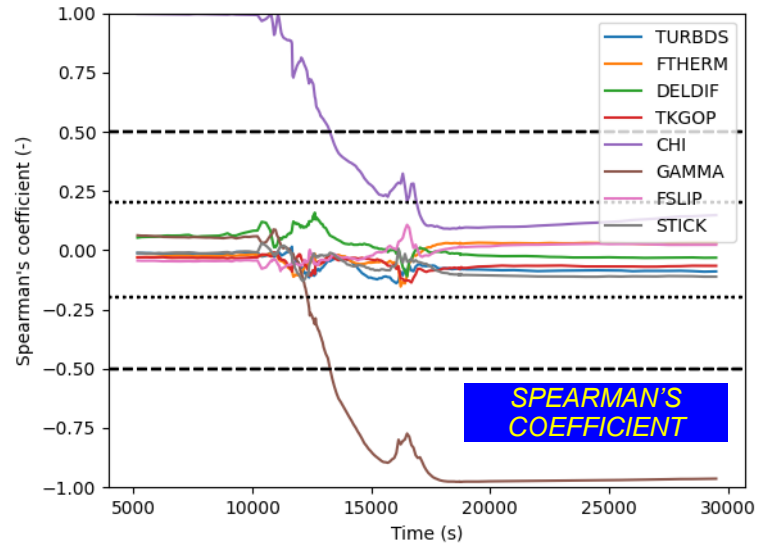
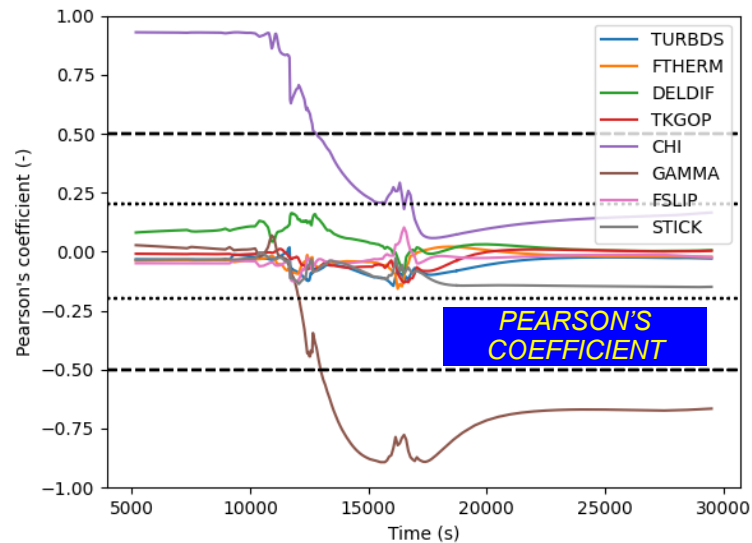
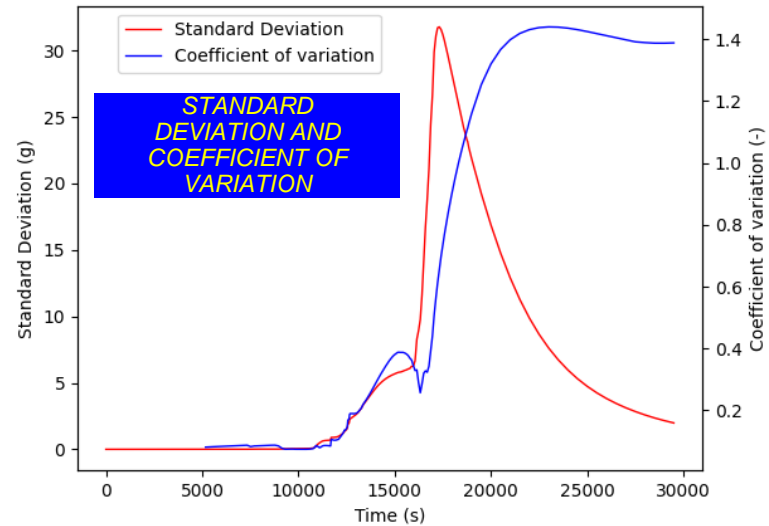
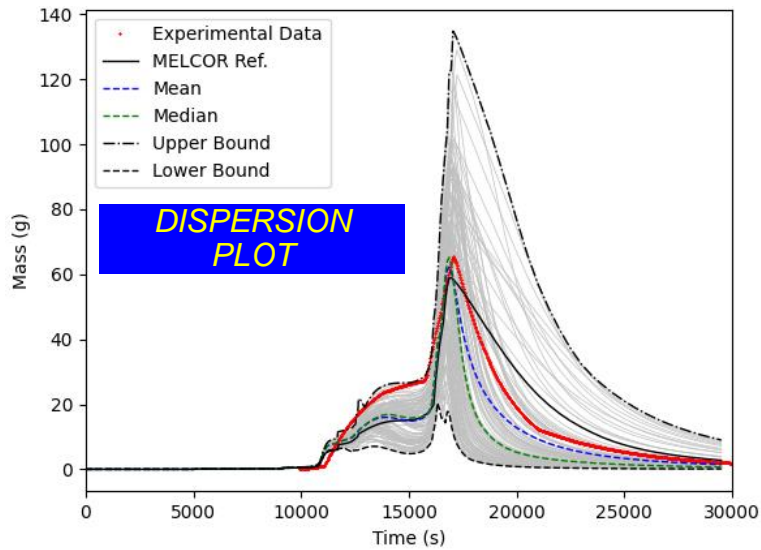

The activity has been done in collaboration with University of Palermo.

ENEA APPLICATIONS IN EU-MUSA PROJECT

CDF AND PDF OF THE MAXIMUM OF THE FOM CONSIDERED AND PEARSON AND PEARSON COEFFICIENT

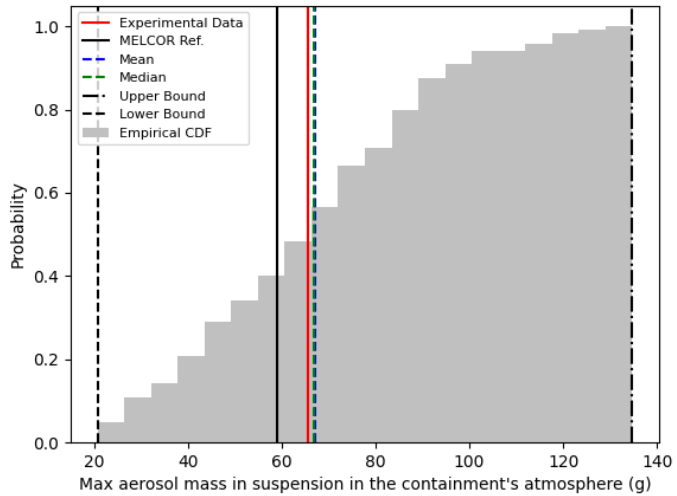

CDF OF THE MAXIMUM VALUE

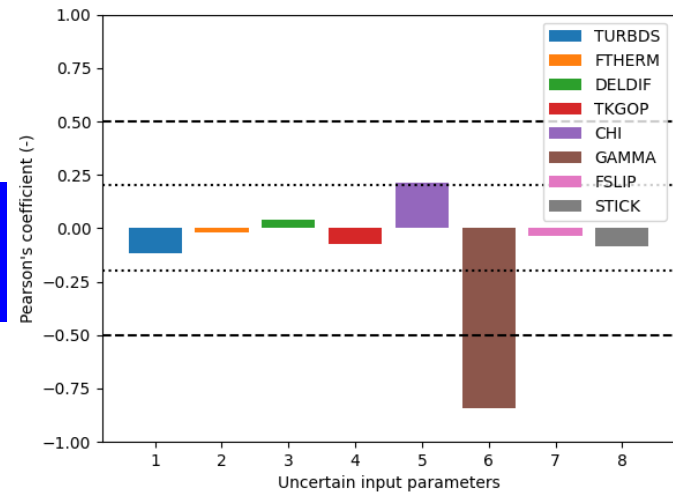

PEARSON'S COEFFICIENT OF THE MAXIMUM VALUE

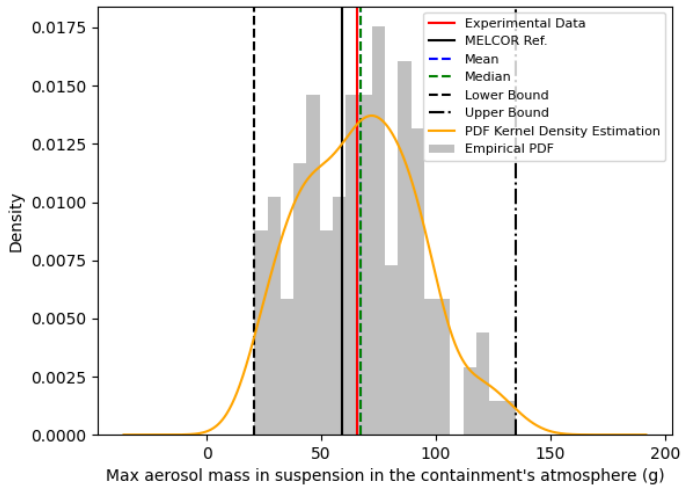

PDF OF THE MAXIMUM VALUE

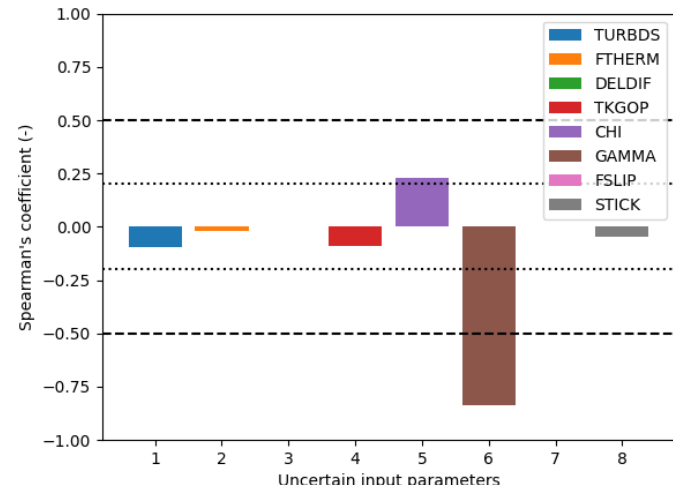

SPEARMAN'S COEFFICIENT OF THE MAXIMUM VALUE



ENEA APPLICATIONS IN EU-MUSA PROJECT

- ❑ At the present stage of the research activity, it has been possible develop a **reference case for the Phebus FPT1**.
- ❑ The FOMs investigated are “Release of iodine from the test fuel bundle”, “Release of Caesium from the test fuel bundle”, “Caesium retention in the circuit”, “Aerosol mass in suspension in the containment’s atmosphere” and “Total deposited iodine in the containment”.
- ❑ The **probabilistic method to propagate input uncertainty by coupling MELCOR/DAKOTA in the SNAP environment/architecture** has been chosen but some issues related to MELCOR runs failure do not allow the finalization of the uncertainty analysis.
- ❑ A **MELCOR/DAKOTA coupling with Python** has been developed. The uncertainty input parameters, selected from the WP2 have been added in the input model and the uncertainty application, assuming the “Aerosol mass in suspension in the containment’s atmosphere” as FOM for the statistical analysis, has been developed.
- ❑ Challenges:
 - **Implementation of Python Stream in SNAP** to resolve the issues related to possible MELCOR runs fail.
 - Implementation on the **cluster** of MELCOR/DAKOTA coupling.

ENEA APPLICATIONS IN EU-MUSA PROJECT

- [1] Schwarz, M., Clement, B., Jones, A.V., 2001. Applicability of Phebus FP results to severe accident safety evaluations and management measures. Nucl. Eng. Des. 209, 173–181.
- [2] Dubourg, R., Faure-Geors H., Nicaise, G., Barrachin, M., 2005. Fission product release in the first two PHEBUS tests FPT0 and FPT1. Nuclear Engineering and Design 235, 2183–2208
- [3] Darnowski, P., Włostowski, M., Stępień, M., Niewiński, G., 2020. Study of the material release during PHÉBUS FPT-1 bundle phase with MELCOR 2.2, Annals of Nuclear Energy 148.
- [4] B. Clément et al., «Thematic network for a Phebus FPT1 international standard problem (THENPHEBISP)», Nuclear Engineering and Design 235, pp. 347-357 (2005).
- [5] Bosland, L., Weber, G., Klein-Hessling, W., Girault, N. & Clement, B., 2012. Modeling and Interpretation of Iodine Behavior in PHEBUS FPT-1 Containment with ASTEC and COCOSYS Codes, Nuclear Technology, 177:1, 36-62.

ENEA APPLICATIONS IN EU-MUSA PROJECT (WP5)

- ❑ Along the **WP5**, named UQAMRA (Uncertainty Quantification in Analysis and Management of Reactor Accidents), of the **EU-MUSA Project**, the Uncertainty Analysis (UA) of a **Station Black-Out (SBO)** in a **generic PWR-900 MWe three-loops western type** has been developed.
- ❑ To carry out the analysis, the **MELCOR/DAKOTA coupling in a Python environment/architecture** developed along the MUSA WP4 has been used.
- ❑ The **aerosol miscellaneous constants** have been selected as uncertain input parameters and the **aerosol suspended mass in the containment's atmosphere** as Figure of Merit (FOM).
- ❑ To conduct the UA the **probabilistic method to propagate input uncertainty has been used**. Based on **Wilks**, in case only one FOM is investigated and for the two-sided tolerance interval, a minimum of 93 code runs is required for a probability and confidence level of 95%. To consider potential code runs failures, a total of 130 code runs have been performed. In this application the failed code runs have not been considered for the UA.

ENEA APPLICATIONS IN EU-MUSA PROJECT (WP5)

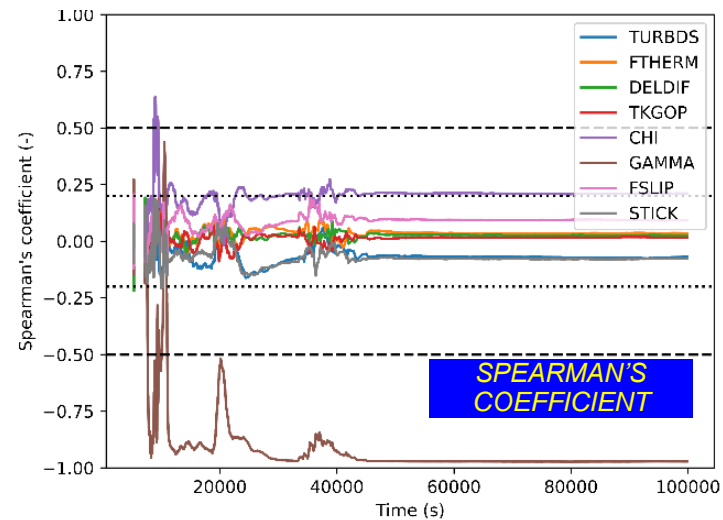
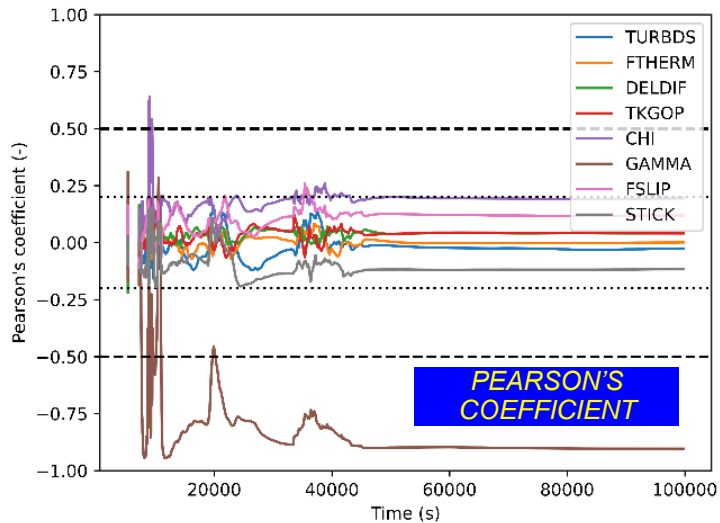
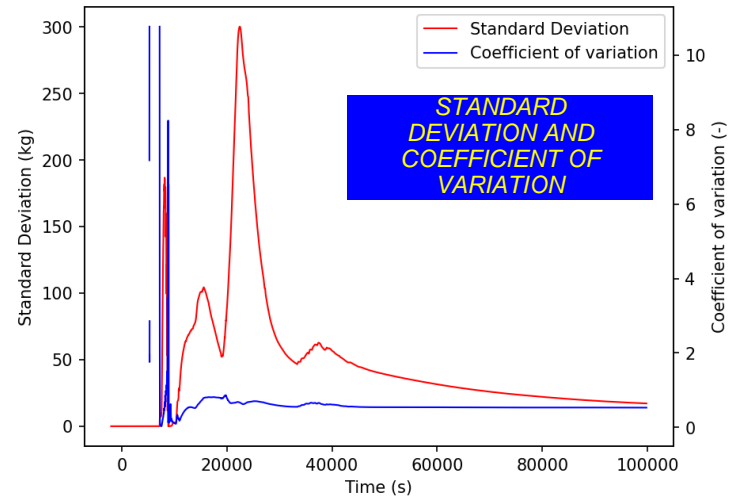
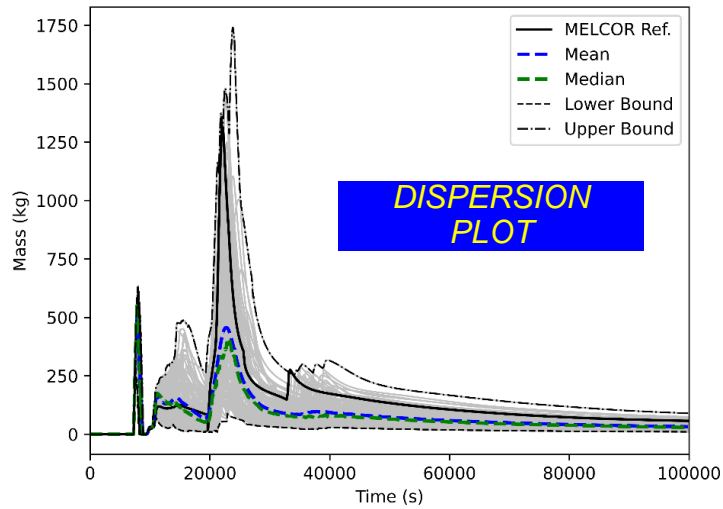

The activity has been done in collaboration with University of Palermo.

ENEA APPLICATIONS IN EU-MUSA PROJECT (WP5)

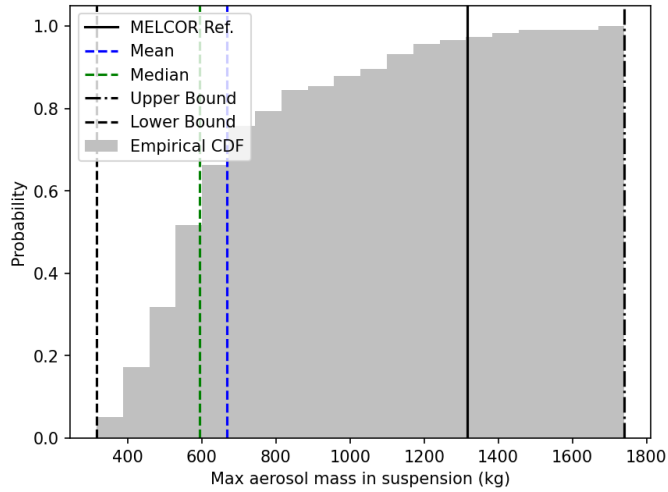

CDF OF THE MAXIMUM VALUE

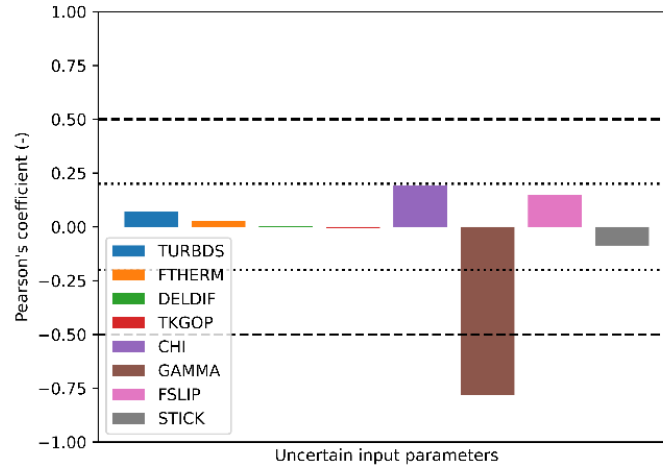

PEARSON'S COEFFICIENT OF THE MAXIMUM VALUE

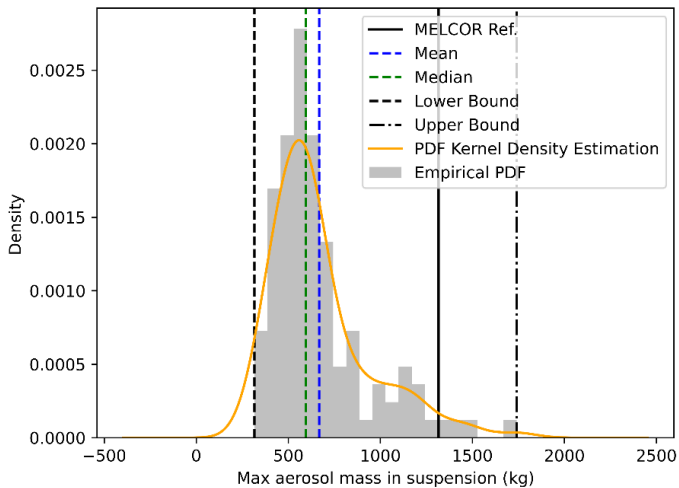

PDF OF THE MAXIMUM VALUE

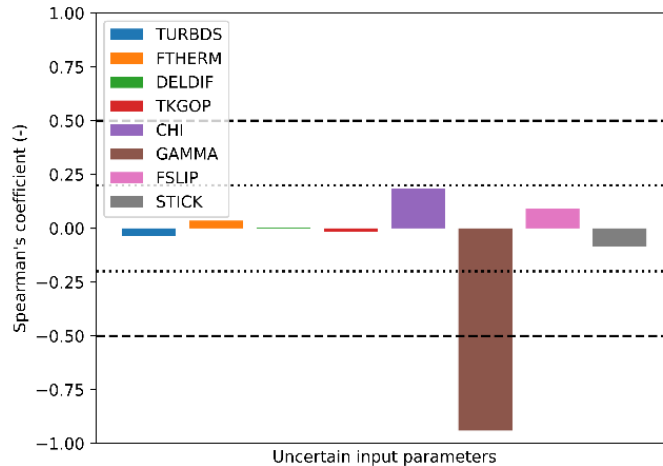

SPEARMAN'S COEFFICIENT OF THE MAXIMUM VALUE

ENEA INVOLVEMENT IN EU-MUSA PROJECT



This project has received funding from the Euratom research and training programme 2014-2018 under grant agreement No 847441



ENEA INVOLVEMENT IN EUROFUSION - Accident analyses within EUROFusion project

ENEA INVOLVMENT IN EUROFUSION - Accident analyses within EUROfusion project:

□ DEMO Tokamak plant: Divertor system analyses

- Preliminary Safety Assessment of Conceptual design of European Nuclear Fusion DEMOnstrative Tokamak reactor plant
- Melcor v1.8.6 fusion, water coolant
- Design Basis Accident considered:
 - Postulated Initiating Event: a loss of coolant in the DV primary cooling circuit of the PFU inside the Vacuum Vessel (VV).
 - Demonstrate Vacuum Vessel pressurization within safety margins (<0.2 Mpa), considered safety provisions, e.g. Vacuum Vessel Pressure Suppression System (VVPSS).

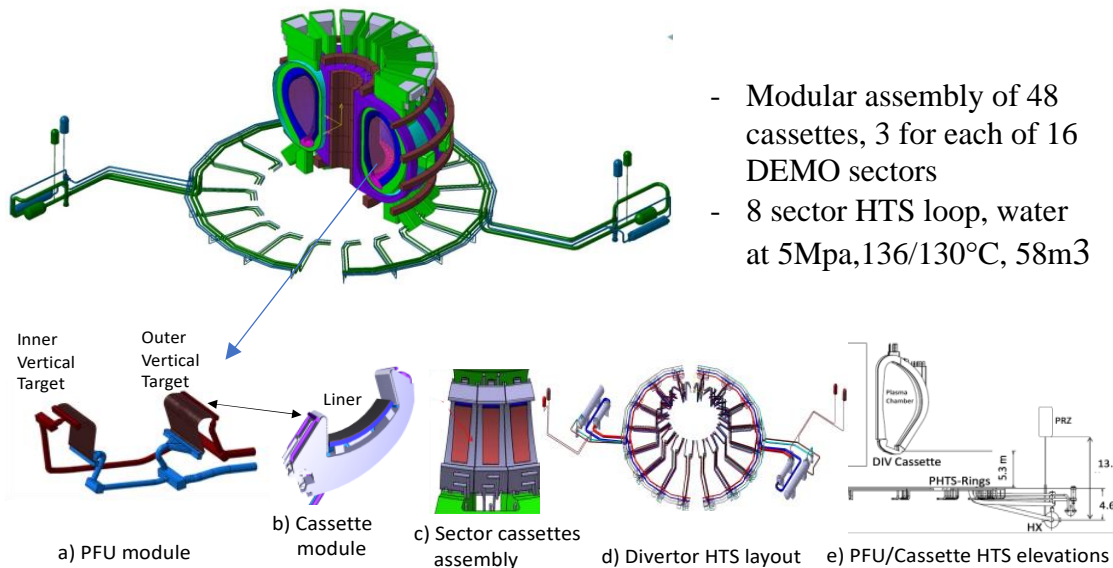

- Modular assembly of 48 cassettes, 3 for each of 16 DEMO sectors
- 8 sector HTS loop, water at 5Mpa, 136/130°C, 58m³

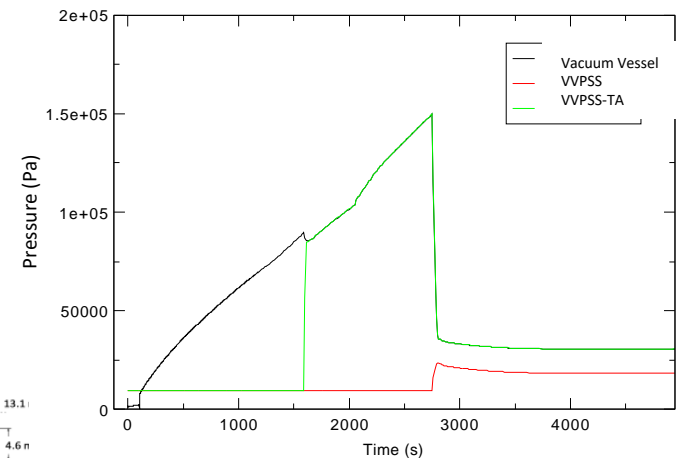

ENEA INVOLVMENT IN EUROFUSION - Accident analyses within EUROfusion project:

☐ **DONES** neutron Irradiation facility

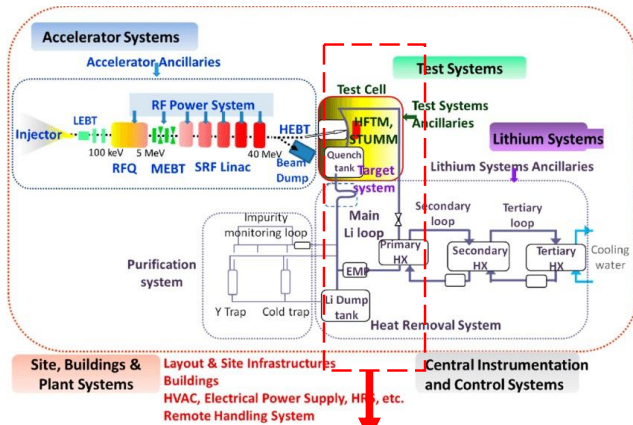

- **DONES:** Accelerated deuterons impacting a liquid lithium flowing film undergo stripping reactions providing neutrons in fusion relevant energy spectrum for material testing purposes
- **Melcor v1.8.6 fusion**, lithium coolant
- **Initiating Event:** Loss of Lithium from primary loop due to large break in Quench Tank (QT) in Test Cell
- **Purpose:**
 - Assess released inventory of lithium
 - Impact on Test Cell containment atmosphere, water cooled floor liner

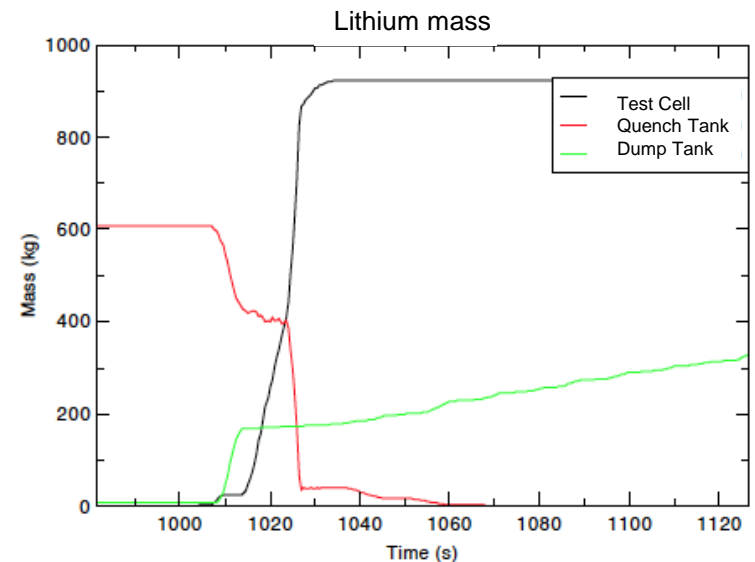
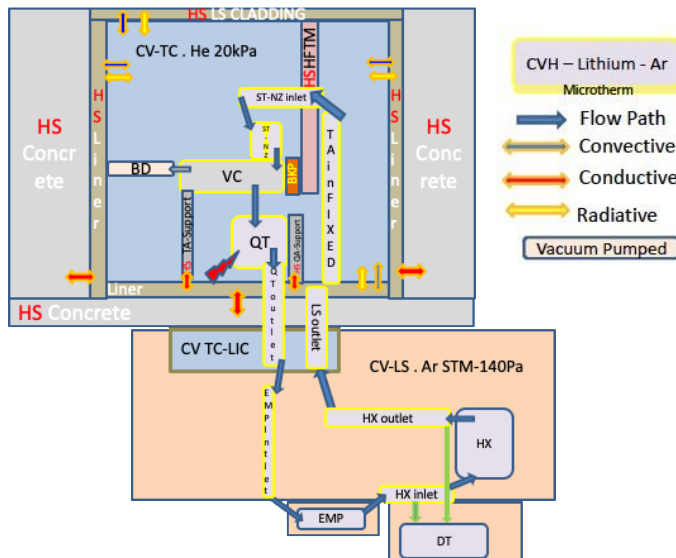

**ANALYSES OF THE PHYSICAL MODELS NECESSARY TO BE
IMPLEMENTED IN MELCOR_2.2 FOR FUSION REACTOR SAFETY
ANALYSES AND THE CURRENT MODEL ALREADY IMPLEMENTED IN
MELCOR FUSION**

ANALYSES OF THE PHYSICAL MODELS NECESSARY TO BE IMPLEMENTED IN MELCOR_2.2 FOR FUSION REACTOR SAFETY ANALYSES AND THE CURRENT MODEL ALREADY IMPLEMENTED IN MELCOR FUSION

- ❑ During the last well organized EMUG meeting in Zagreb (25-27 April 2018), there was a very interesting discussion about the **physical models necessary to be implemented in MELCOR_2.2 for fusion reactor safety analyses and the current model already implemented in MELCOR fusion.**
- ❑ Since the session4 ("**GEN IV and Fusion Applications**") was chaired by ENEA, ENEA proposed an action that was agreed by all the Colleagues attending the meeting: ENEA will contact all the EMUG Partners to collect the information about physical models necessary to be implemented in MELCOR_2.2 for fusion reactor safety analyses and the current model already implemented in MELCOR fusion.
- ❑ ENEA has already contacted all the EMUG Partners to collect the information about physical models necessary to be implemented in MELCOR_2.2 for fusion reactor safety analyses and the current models already implemented in MELCOR fusion.
- ❑ These are the information requested:
 - Description of phenomenon of interest;
 - Safety relevance of the phenomenon for fusion reactor;
 - Rank of importance (1: low; 2: medium; 3: High) ==> priority for code development;
 - If models to characterize the phenomenon have been already implemented in MELCOR fusion and the related version.
- ❑ The final report related to this activity is in a draft form for comments and will be soon finalized and distributed.
- ❑ The activity has been developed in collaboration with **BELV, CCFE, CIEMAT, KIT, CVR, Jacobsen Analytics, JSI, POLITO, SANDIA, UNIROMA1, UNIPA, UNIPI.**

ANALYSES OF THE PHYSICAL MODELS NECESSARY TO BE IMPLEMENTED IN MELCOR_2.2 FOR FUSION REACTOR SAFETY ANALYSES AND THE CURRENT MODEL ALREADY IMPLEMENTED IN MELCOR FUSION

ISSUE N	ISSUE DESCRIPTION	Priority	Complexity of implementation	MELCOR_FUSION REFERENCES
1	Introduce additional working fluids with multiphase capabilities	3		[2][3]
2	Implementation of the possibility to use different fluids in different circuits at the same time during the calculation	3		-
3	Introduce models for chemical reactions in the case of different working fluids	2		[6][7][13]
4	Model steam oxidation of the Plasma-Facing-Component (PFC)	2		[2][4]
5	Model air oxidation of the Plasma-Facing-Component (PFC)	2		[4]
6	Introduce models for aerosols turbulent and inertial deposition	2		[2]
7	Introduce models for aerosols deposition with different carrying gas and mixtures	2		[2]
8	Introduce aerosol resuspension model	2		[9]
9	Extend the deposition and resuspension modelling to <u>take into account</u> remnant magnetization effects	1		
10	Introduce models for aerosols transport in multifluid (multi-working fluid) simulation.	2		-
11	Implementation of specific heat transfer correlations for simulating He as working fluid in the geometry of interest.	2		-
12	Standard Scrubber model in FL Package for Helium.	1		-
13	Introduce dissolved NCG species within working fluids	2		-
14	Implement magnetic pump modelling (for design) and features (e.g. coast-down, etc)	1		-
15	Include MHD effects on heat transfer correlation and pressure drop evaluation (for design)	1		-
16	Extend the water properties below triple point temperature	2		[2]
17	Air condensation onto cryogenic structures	2		[4][14]
18	Helium condensation onto cryogenic structures	2		[2]
19	Allow low temperature operations (>3K) and cryogen working fluids	2		
20	Extend material physical properties to cryogenic range	3		
21	Enclosure radiant heat transfer	2		[2]
22	A common release MELCOR 2.x incl. fusion features	1		
23	Hydrogen tritium oxide transport			
24	Tritium transport			
25	Dust and Hydrogen explosion			

ANALYSES OF THE PHYSICAL MODELS NECESSARY TO BE IMPLEMENTED IN MELCOR_2.2 FOR FUSION REACTOR SAFETY ANALYSES AND THE CURRENT MODEL ALREADY IMPLEMENTED IN MELCOR FUSION

- ❑ Within the **European MELCOR User Group (EMUG)**, organized in the framework of **USNRC Cooperative Severe Accident Research Program (CSARP)**, an activity on the **evaluation of the applicability of MELCOR 2.2 for fusion safety analyses** has been launched and it has been coordinated by ENEA.
- ❑ The aim of the activity was to **identify the physical models to be implemented in MELCOR 2.2 necessary for fusion safety analyses**, and to check if those models are already available in MELCOR 1.8.6 for fusion version, developed by Idaho National Laboratory.
- ❑ From this activity, a list of modeling needs, emerged from the safety analyses of fusion-related installations, have been identified and described.
- ❑ **A paper has been presented at the SOFT 2022 conference.** The identified modeling needs are discussed, together with the current status of the MELCOR code development. The ultimate goal is to have in the near future a single integrated MELCOR release capable to treat both fission and fusion applications.



ENEA INVOLVEMENT IN ITALIAN SAFETY ASSESSMENT ACTIVITY

ENEA INVOLVEMENT IN ITALIAN SAFETY ASSESSMENT ACTIVITY

- ❑ The ENEA activities related to the MELCOR code are oriented to the simulation and evaluation of severe accident evolutions and source term for “**safety assessment**”, mainly focusing on the characteristics of NPPs located at the Italian border.
- ❑ The activity is the basis for the development of a **source term database** to be used as an input for the MACCS code available in ENEA .
 - In-vessel analysis with the MELCOR 2.1 of three unmitigated LBLOCA severe accidents in a generic PWR of 900 MWe, caused by three distinct initiator events: a) **Double-ended rupture of the cold leg of Loop 1**; b) **Double-ended rupture of the hot leg of Loop 1**; c) **Double-ended rupture of the surge line**. The activity has been conducted in ENEA in the framework of a Master Degree thesis with the University of Bologna.
 - **A short term Station Blackout (SBO)** accident leading to a loss of the ultimate heat sink, and the possible thermal induced SGTR, with consequent evaluation of the source term has been calculated by MELCOR code.
 - **A 2 inch unmitigated SBLOCA** has been calculated by MELCOR code:
 - The effect of the discharge coefficient at the break in the calculated results will be investigated.
 - The results could be compared with analogous ASTEC and MAAP results (independent user cross walk activity) done by JRC.
 - **LFW and LBLOCA transient with MELCOR code have been performed by Sapienza University of Rome.**

ITALIAN SAFETY ASSESSMENT ACTIVITY - 2 INCH UNMITIGATED SBLOCA

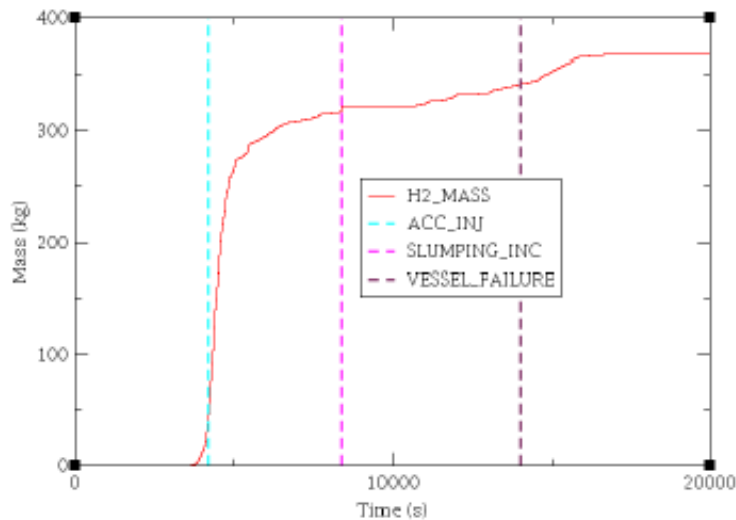
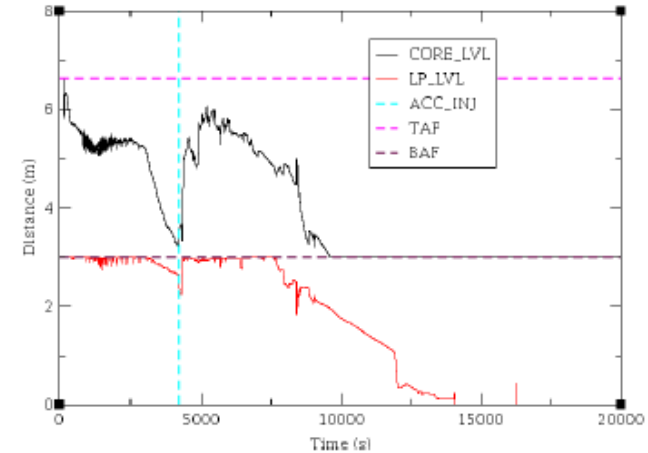
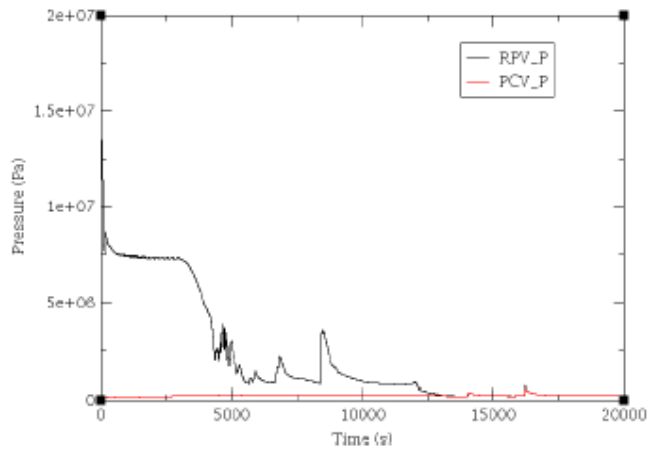

RELEVANT PHENOMENOLOGICAL ASPECTS	MELCOR
SGs (1,2,3) Cycling Inception (s)	48, 50,50
Two Phase Inception in the HL 1,2,3 (s)	70,88,88
H2 Start (s)	2000
TCL 1300K (s)	3570*
TCL 1855K (s)	3870*
Start of Accumulators 1,2,3 Discharge (s)	4200
Upper Core Part Failure Inception (s)	4930
Massive Slumping Inception (s)	8390
Vessel Failure (s)	14000

* Radial ring 1 and axial level 16

ENEA INVOLVMENT IN ASCOM PROJECT

- ❑ The aim of this activity is to study the main phenomena during a **postulate unmitigated 2-inch Cold Leg LOCA accident** in a generic PWR 900 MWe three loops, especially as regards the thermal-hydraulic phases of the transient core degradation phenomena, the oxidation and hydrogen production processes.
- ❑ This transient is evaluated by the **SA code ASTEC** and compared with the results obtained with the **SA code MELCOR**.
- ❑ The transient selected for this analysis is initiated by a 2-inch break in the Cold Leg (CL) of the loop 1, where the Pressurizer (PRZ) is located. It is assumed that among the safety systems **only the passive accumulators are in operation**.
- ❑ The break event is coupled with:
 - Loss of offsite Alternating Current (AC) power;
 - Failure of all the diesel generators.

This determines:

- Primary pressure control systems (heaters and PRZ spray),
 - Chemical and Volume Control System (CVCS),
 - Reactor Coolant Pump (RCP) seal injection,
 - Active safety injection systems (High Pressure Injection System, HPIS, and Low Pressure Injection System, LPIS),
 - Motor-driven Auxiliary Feedwater (MDAFW) system,
- are unavailable.

ENEA INVOLVMENT IN ASCOM PROJECT

❑ The following hypotheses are also considered:

- Reactor SCRAM and Steam Generators (SGs) isolation at the Start Of the Transient (SOT);
- Independent failure of the Turbine Driven Auxiliary Feedwater (TDAFW) pump (no AFW available);
- No primary boundary structures thermal induced degradation phenomena
- Primary and secondary Steam Relief Valves (SRVs) availability throughout the accident evolution.
- Safety Valves of Pressure Compensator (SEBIM) manually stuck open when the core exit temperature reaches 650 °C.

❑ The transient has been analyzed until the Lower Head (LH) failure.

The activity has been done in collaboration with University of Palermo and University of Bologna.

ENEA INVOLVMENT IN ASCOM PROJECT

Relevant Phenomenological Aspects [s]	ASTEC	MELCOR	DISCR [%]
SOT, SCRAM, SGs isolation	0	0	0
SG 1,2,3 cycling inception	38,30,30	30,25,25	21.05,16.67,16.67
Core TAF uncovered	204	126	38.24
H₂ generation start	2923	3336	14.13
T > 1300 K (before accumulators injection)	-	3505	-
T > 1855 K (before accumulators injection)	-	3798	
Start of accumulators 1,2,3 discharge	3713,3713,3713	4236,4238,4238	14.09,14.14,14.14
Core BAF uncover	3773	-	-
T > 1300 K (after accumulators injection)	7208	8086	12.18
T > 1855 K (after accumulators injection)	7528	8707	15.66
Core BAF uncover	13702	10006	26.97
Slumping	16564	13253	19.99
LH failure	20394	20160	1.15

ENEA INVOLVMENT IN ASCOM PROJECT

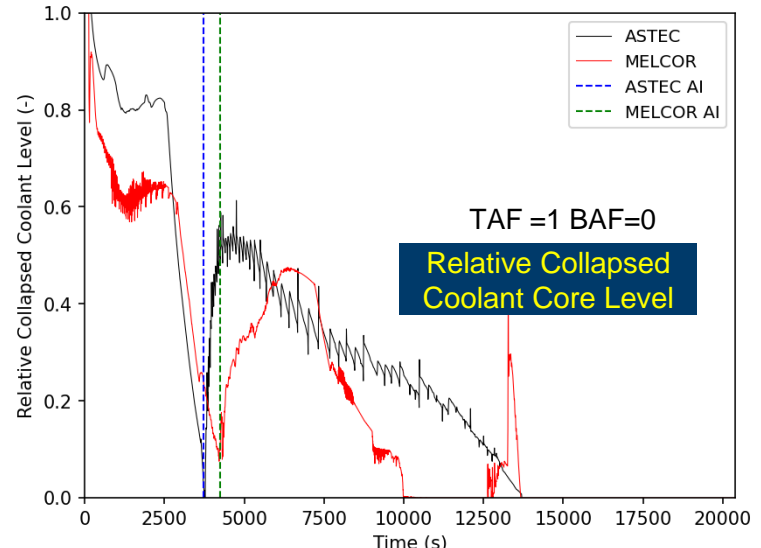
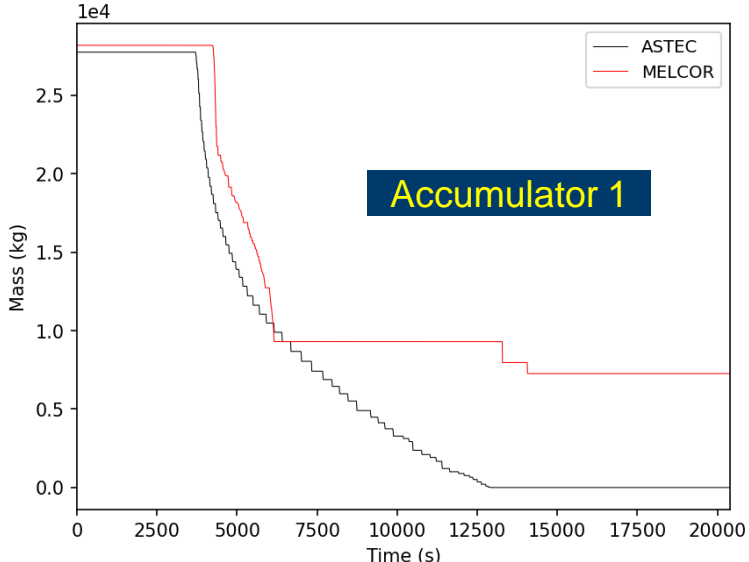
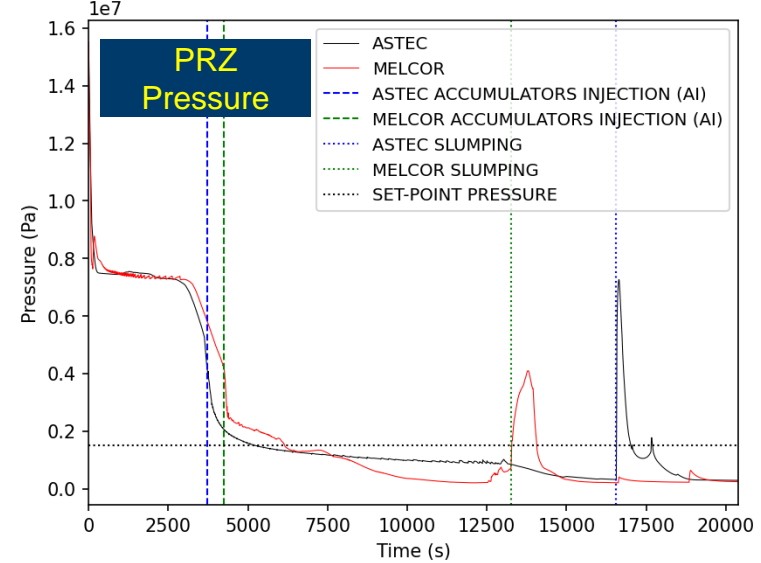
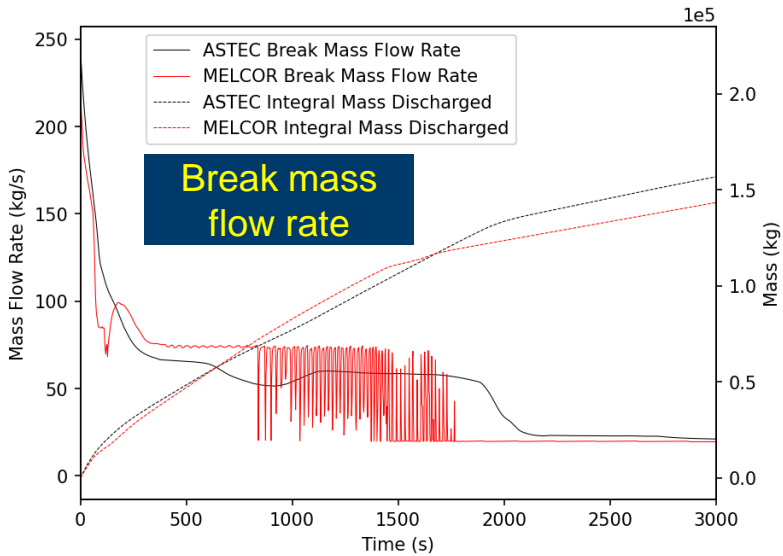

ENEA INVOLVMENT IN ASCOM PROJECT

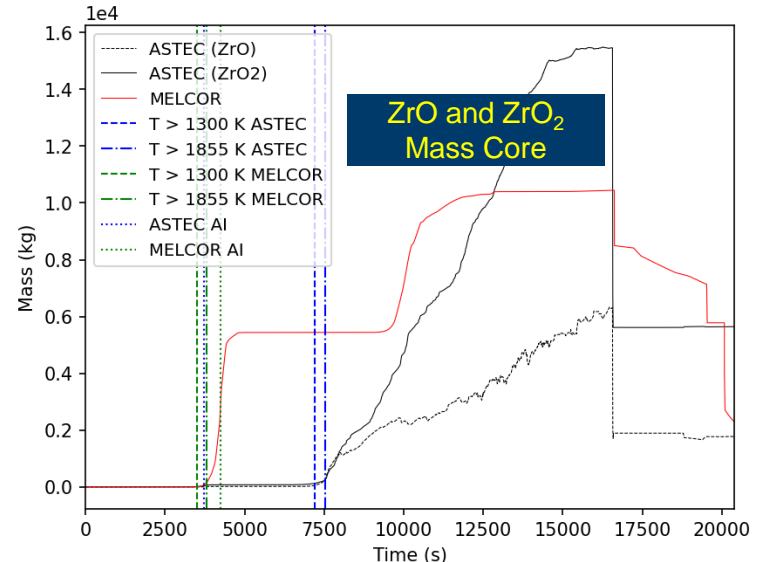
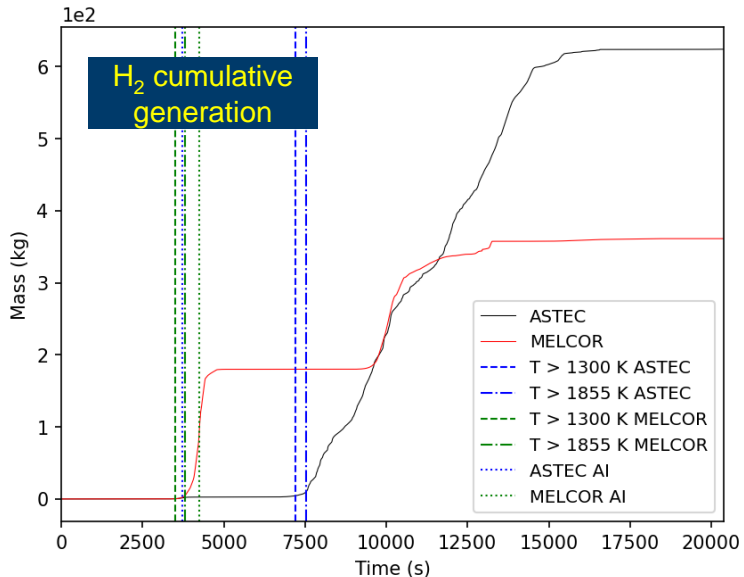
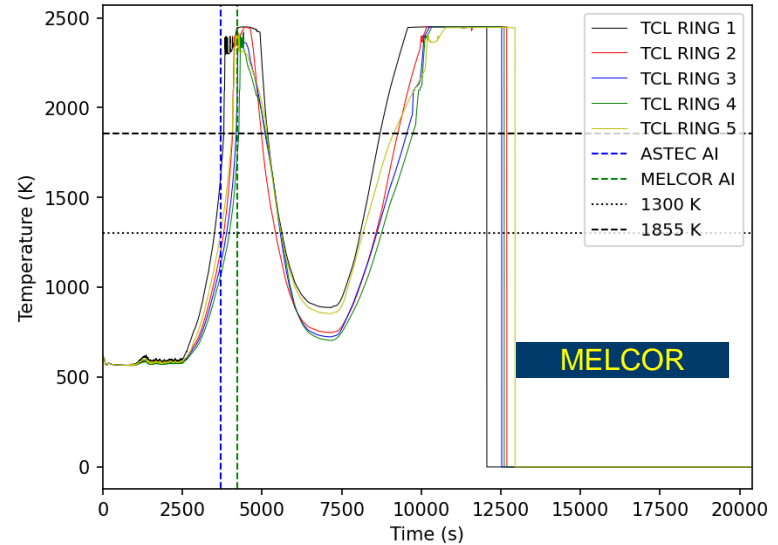
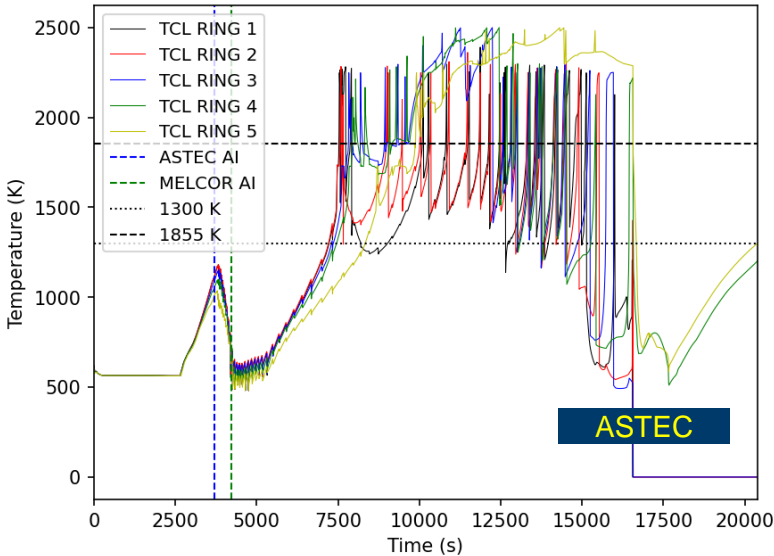

TRANSIENT ANALYSES: ASTEC CORE DEGRADATION ANIMATIONS

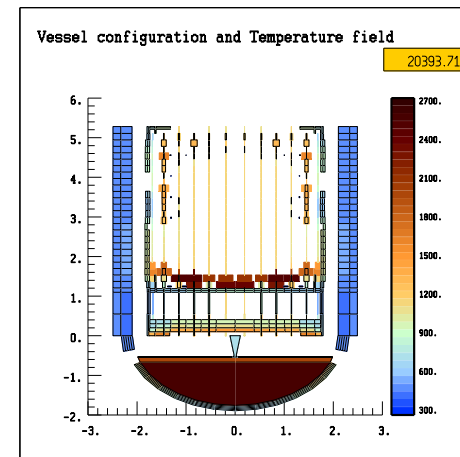
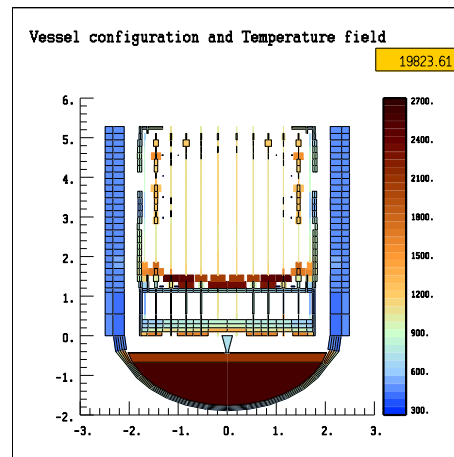
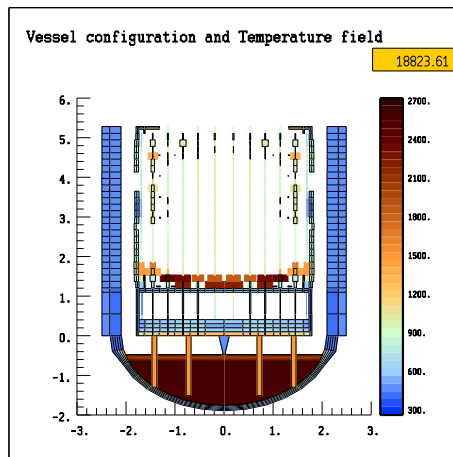
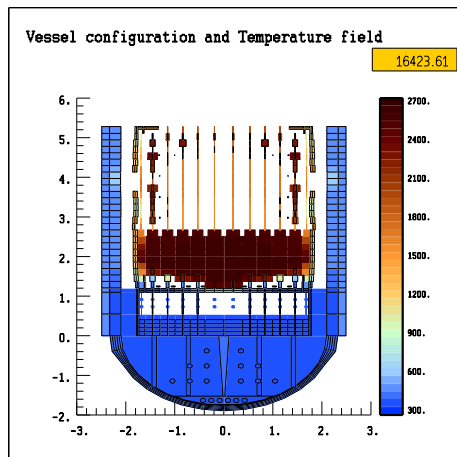
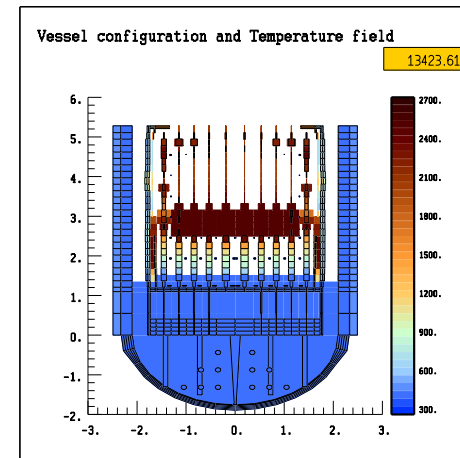
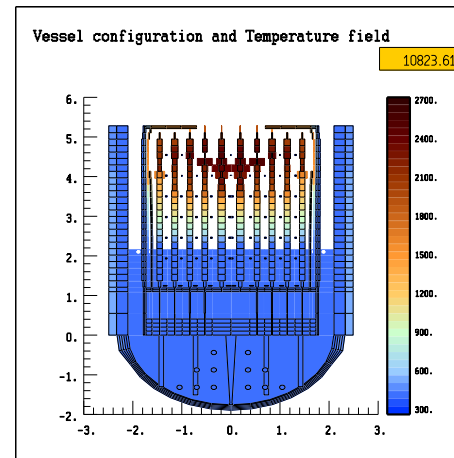
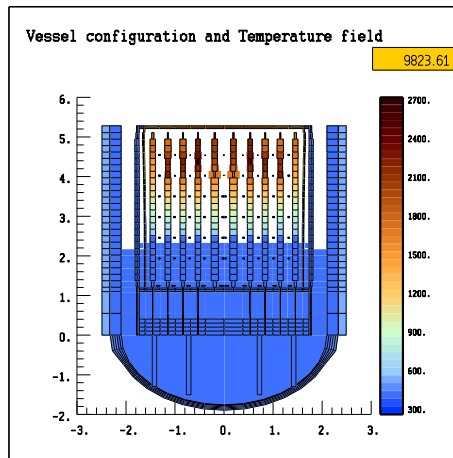
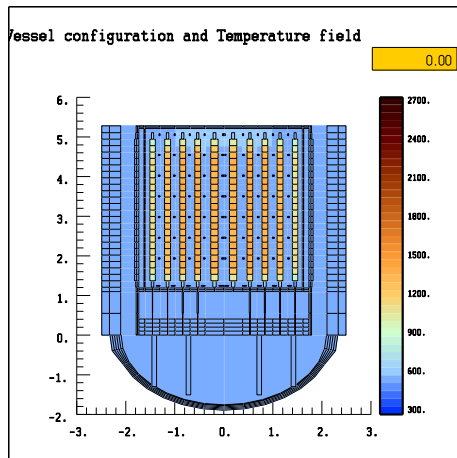

TRANSIENT ANALYSES: MELCOR CORE DEGRADATION ANIMATIONS

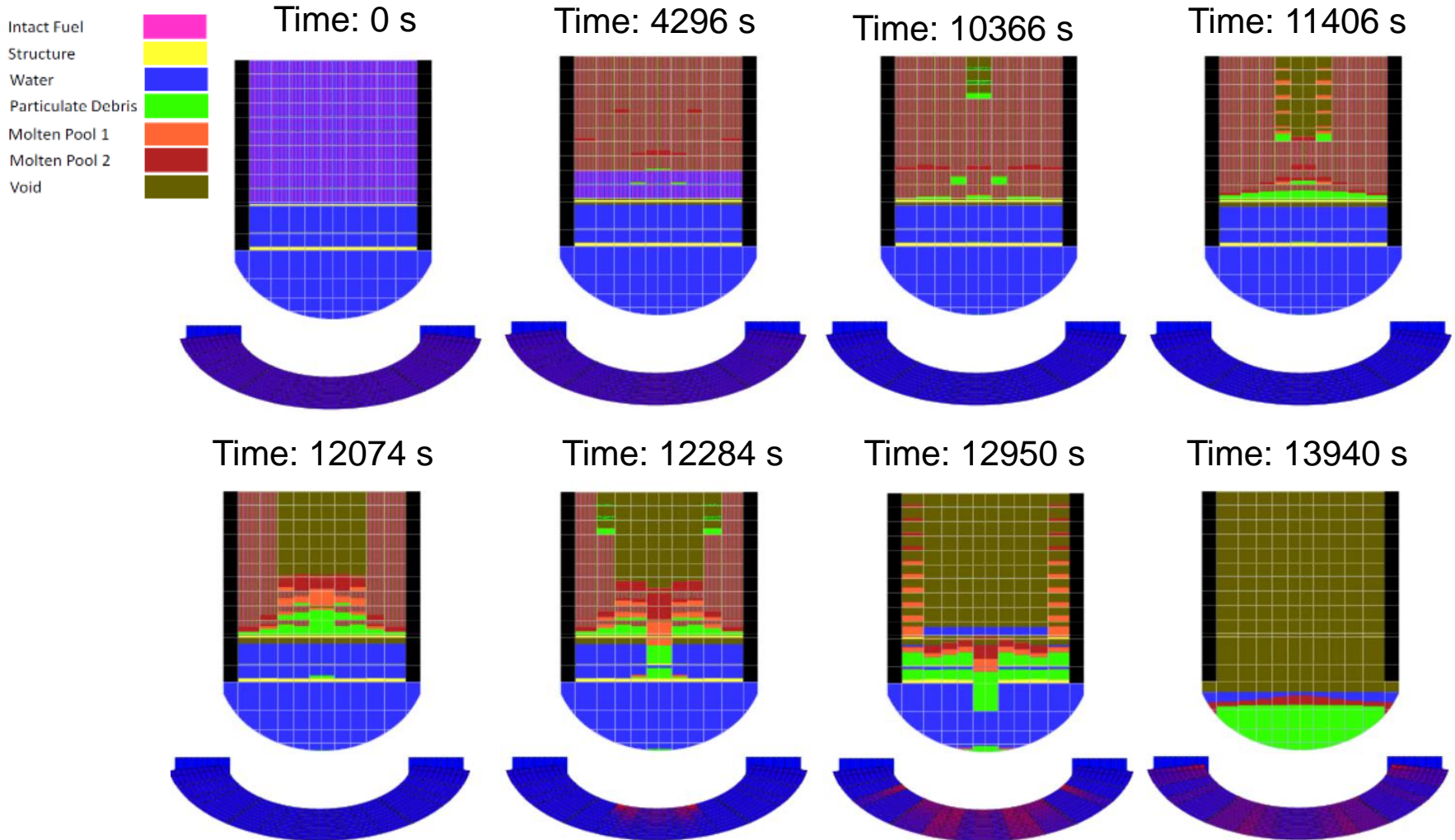

ENEA INVOLVEMENT IN ASCOM PROJECT

- ❑ Similar thermal-hydraulic behaviour from the qualitative point of view between the two calculations even some quantitative differences are related to the break flow rate and the accumulator behaviour.
- ❑ Difference in terms of cladding temperature and the consequent H₂ generation before and after the accumulator injection.
- ❑ Even though MELCOR predict a faster degradation than ASTEC (also related to the different accumulator behaviour) and a consequent earlier corium relocation to the LP, the different retention time of the corium in the LP allow to have a discrepancy of about 1% for the LH failure, which occurs first in MELCOR than in ASTEC.
- ❑ The observed discrepancies underline some modelling differences between the two codes and details studies are in progress to characterize them and the user effect in view of uncertainty estimation.
- ❑ In relation to the user effect, in the case of MELCOR code the effect of the accumulator modelling is under investigation.
- ❑ *A paper has been published:*

G Agnello et al 2022 J. Phys.: Conf. Ser. 2177 012024 doi:10.1088/1742-6596/2177/1/012024

ACKNOWLEDGEMENTS

- ❑ Special thanks to USNRC, IRSN and Sandia National Laboratories for their comments during the preparation of the activities



SENSITIVITY ANALYSIS ON ACCUMULATORS MODELLING WITH MELCOR CODE

SENSITIVITY ANALYSIS ON ACCUMULATORS MODELLING WITH MELCOR CODE

- ❑ To give some insights about the **code results discrepancies attributed to the different modelling approaches** on the main SA phenomena, **a sensitivity analysis on the accumulators modelling** on the SA code MELCOR 2.2 has been carried out.
- ❑ The sensitivity analysis, presented in this work, has been carried out considering a **generic PWR-900 MWe three-loops western type** and an **unmitigated Small Break Loss Of Coolant Accident (SBLOCA)** as postulated SA scenario.
- ❑ The **in-vessel phase** has been analyzed and the **effect of the accumulator modelling** on the main **thermal-hydraulic** and **core degradation phenomena** have been investigated.
- ❑ The sensitivity analysis has been carried out considering **two different accumulators modelling approaches**:
 - In the first one, the accumulators have been modelled using **Control Volume Hydrodynamics (CVH) Control Volumes (CVs)**.
 - In the second modelling approach, the accumulators have been modelled with the dedicated **MELCOR ACC Package**. A sensitivity analysis considering the **isothermal** and the **adiabatic expansions**. Furthermore, in order to investigate the effects of intermediate polytropic transformations between the isothermal and adiabatic ones, three additional cases, characterized by expansion coefficients of **1.1, 1.2 and 1.3** have been considered.

The activity has been done in collaboration with University of Palermo.

SENSITIVITY ANALYSIS ON ACCUMULATORS MODELLING WITH MELCOR CODE

Relevant Phenomenological events [s]	CVH ACC			ACC			
	NO ISOL	ISOL	ISOTH	C = 1.1	C = 1.2	C = 1.3	ADIAB
SOT, SCRAM, SGs isolation	0	0	0	0	0	0	0
SG 1,2,3 cycling inception	25,20,20	25,20,20	25,20,20	25,20,20	25,20,20	25,20,20	25,20,20
Core TAF uncover	115	115	115	115	115	115	115
H₂ generation start	3065	3065	3065	3065	3065	3065	3065
T > 1300 K (before accumulators injection)	3205	3205	3205	3205	3205	3205	3205
T > 1855 K (before accumulators injection)	3480	3480	3480	3480	3480	3480	3480
Core BAF uncover (before accumulators injection)	3687	3687	3687	3687	3687	3687	3687
Start of accumulators discharge	3740	3740	3740	3740	3740	3740	3740
Stop of accumulators discharge	5350	5150	3780	5500	6050	8000	9000
T > 1300 K (after accumulators injection)	8095	7615	5895	8405	8925	8690	9090
T > 1855 K (after accumulators injection)	8725	8250	6415	9025	9655	9525	10110
Core BAF uncover (after accumulators injection)	9835	9500	7490	10174	10670	11500	12225
Core slumping	12980	12530	11200	13490	14270	15150	15780
LH failure	17486	18170	21115	18285	18900	19900	20840

SENSITIVITY ANALYSIS ON ACCUMULATORS MODELLING WITH MELCOR CODE

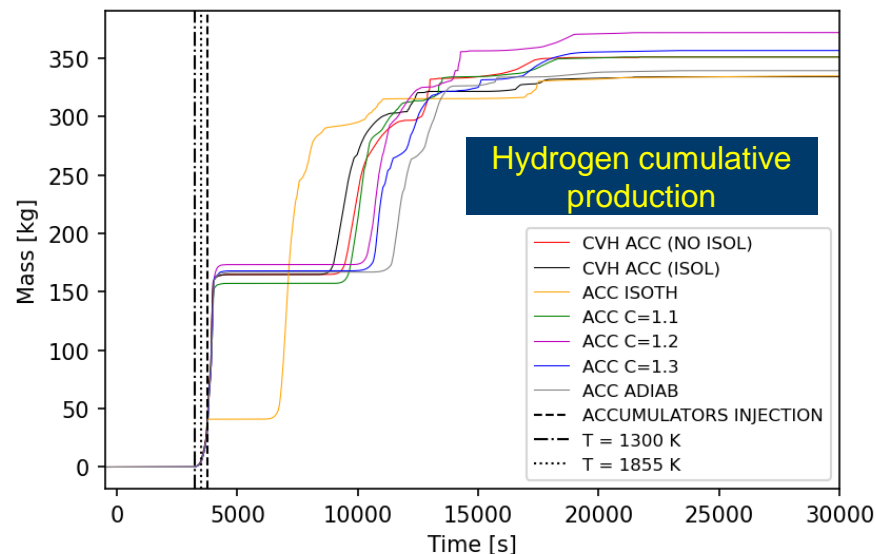
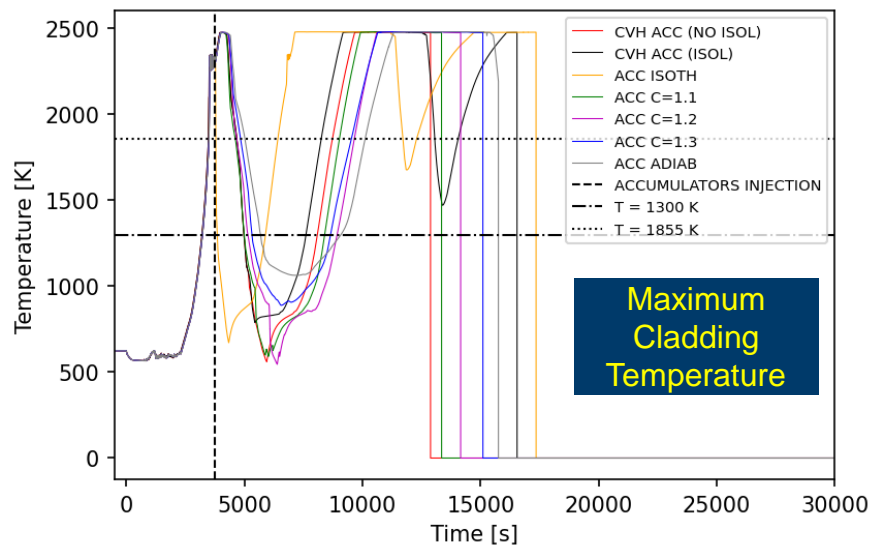
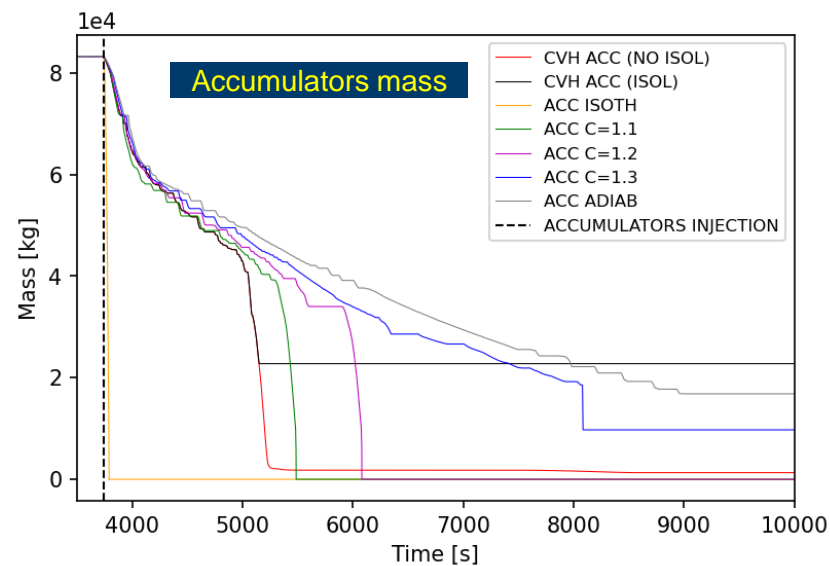
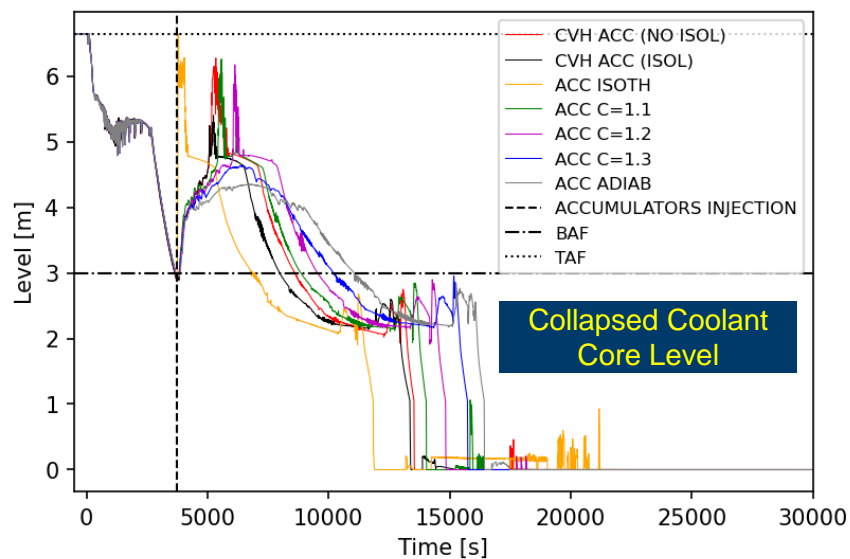

SENSITIVITY ANALYSIS ON ACCUMULATORS MODELLING WITH MELCOR CODE

- ❑ After the accumulators discharge, occurring at 3740 s after the SOT, all the model considered presents a similar trend in terms of water discharged from a qualitative point of view.
 - An exception is represented by the ACC ISOTH model predicting a fast discharge of all the water inventory in the PCS of the reactor.

- ❑ After 5000 s, the models considered presents a different behavior in terms of total mass discharge and mass flow rate influencing the core reflooding, cladding temperature and hydrogen rate production.

- ❑ The slower accumulator water injection in the case of ACC ADIAB determines a delay of the total core damage and the core slumping.

- ❑ The core relocated in the LP first in case of ACC ISOTH the LH failure occurs first in case of CVH ACC without accumulators isolation, probably due to the major quantity of steam available for oxidation reaction, determining a major core damaging. In case of ACC ISOTH the LH failure occurs at about 21115 s after the SOT and a less quantity of corium material relocated along the slumping is underlined.

- ❑ A paper has been presented at ERMSAR22.



Development of a Design 2 MELCOR input-deck in the frame of SASPAM-SA

HORIZON EURATOM SASPAM-SA PROJECT



Key Object and Outcomes

SAFETY ANALYSIS OF SMR WITH PASSIVE
MITIGATION STRATEGIES - SEVERE ACCIDENT

- ❑ SASPAM-SA (Safety Analysis of SMR with Passive Mitigation strategies - Severe Accident) project proposal has been funded in HORIZON-EURATOM-2021-NRT-01-01, “**Safety of operating nuclear power plants and research reactors**”.
- ❑ Key Objective of SASPAM-SA:
 - *Investigate the applicability and transfer of the operating large-LWR reactor knowledge and know-how to the near-term deployment of integral PWR (iPWR), in the view of Severe Accident (SA) and Emergency Planning Zone (EPZ) European licensing analyses needs.*
- ❑ Key Outcomes of SASPAM-SA :
 - *To be **supportive for the iPWR licensing process** by bringing up key elements of the safety demonstration needed;*
 - *To **speed up the licensing and siting process** of iPWRs in Europe.*



HORIZON EURATOM SASPAM-SA PROJECT



Key Highlights and Consortium

□ Key Highlights:

- The applicability of large-LWR reactor knowledge & know-how to the near-term deployment iPWR, in view of SA and EPZ analyses, will be assessed and consolidated;
 - The research priorities will be identified in terms of methodology, code development and experimental needs;
 - The knowledge gained can support Regulators in decision-making as well as Industry and TSOs in assessing the applicability of iPWR safety features.
- The project is coordinated by ENEA and twenty-three Organizations from fourteen Countries are involved: ENEA, CIEMAT, CNRS, EDF, FZJ, GRS, INRNE, IRSN, KIT, KTH, LEI, POLIMI, RATEN, RUB, SINTEC, SSTC-NRS, SURO, TRACTEBEL, TUS, UNIROMA1, VTT, PSI, JRC.
- Project coordinator: Fulvio Mascari (fulvio.mascari@enea.it)

SAFETY ANALYSIS OF SMR WITH PASSIVE
MITIGATION STRATEGIES - SEVERE ACCIDENT



GENERIC IPWR DESIGN CONSIDERED FOR THE ANALYSES

- ❑ To maximize the knowledge transferability and impacts of the project **two generic design-concepts**, characterized by different evolutionary innovations in comparison with larger operating reactor, have been selected for the analyses.
- ❑ These two generic reactor concepts include the **main iPWR design features**, considered in the most promising designs ready to go on the European market, allowing to assess in a wider way the capability of codes (SA and CFD) to simulate the SA phenomena typical of iPWR.
- ❑ **It is not the project's objective to assess the generic reactor designs selected but, based on the project findings, allow a more general statement on the code's applicability to currently favored designs under postulated SA condition.**

GENERIC IPWR DESIGN CONSIDERED FOR THE ANALYSES

- ❑ The activity here presented has been developed in the frame of the WP2, Input deck development and hypothetical SA scenarios assessment (SCENARIOS) coordinated by KIT, having as a major objective the development of generic but representative iPWR SA code input-decks and the analysis of the iPWR behavior under hypothetical postulated SA conditions.
- ❑ The scenarios identified are useful for the analyses of the severe accident code capability in modelling iPWRs and the evaluation of bottlenecks (if any)
- ❑ The activity is developed in collaboration with UNIROMA1 and CIEMAT;
- ❑ The studied plant is a generic iPWR characterized by:
 - The use of several passive systems;
 - Dry containment;
 - Electric power of about 300 Mwe;
 - In the framework of the SASPAM-SA project is named Design 2.
- ❑ The integral RPV contains, other than the core, all the major RCS components, which include:
 - Reactor coolant pumps (RCPs),
 - Compact Steam Generator (SG), e.g. helical coil bundles once-through SG,
 - Pressurizer (PRZ) and heaters.

GENERIC IPWR DESIGN CONSIDERED FOR THE ANALYSES

- ❑ Therefore, Design 2 is a generic reactor concept that could be representative of reactor concepts of interest.
- ❑ The Design 2 configuration permits the elimination of the occurrence of some accident sequences:
 - Large Loss Of Coolant Accident (LOCAs) are eliminated by the integral layout of the RPV
 - Only Small break LOCA can take place and will be studied.
- ❑ Since the aim of the activity is to test the capability of the MELCOR code in reproducing the behavior of different passive safety systems and their interaction in a SMR configuration, in order to analyze MELCOR capability in a wider way the following passive systems have been considered:
 - Decay heat removal;
 - Primary automatic depressurization;
 - High pressure safety injection;
 - Containment pressure suppression;
 - Low pressure safety injection;
 - Flooding of the Reactor Cavity (RC).

GENERIC iPWR DESIGN CONSIDERED FOR THE ANALYSES

- ❑ In order to develop the MELCOR input-deck, a reference database was needed.
- ❑ Considering the characteristics of Design 2 reactor type and the selected passive systems, a generic IRIS SMR type has been considered as reference for this analysis.
- ❑ During the MELCOR nodalization of the generic IRIS design, no proprietary data have been used

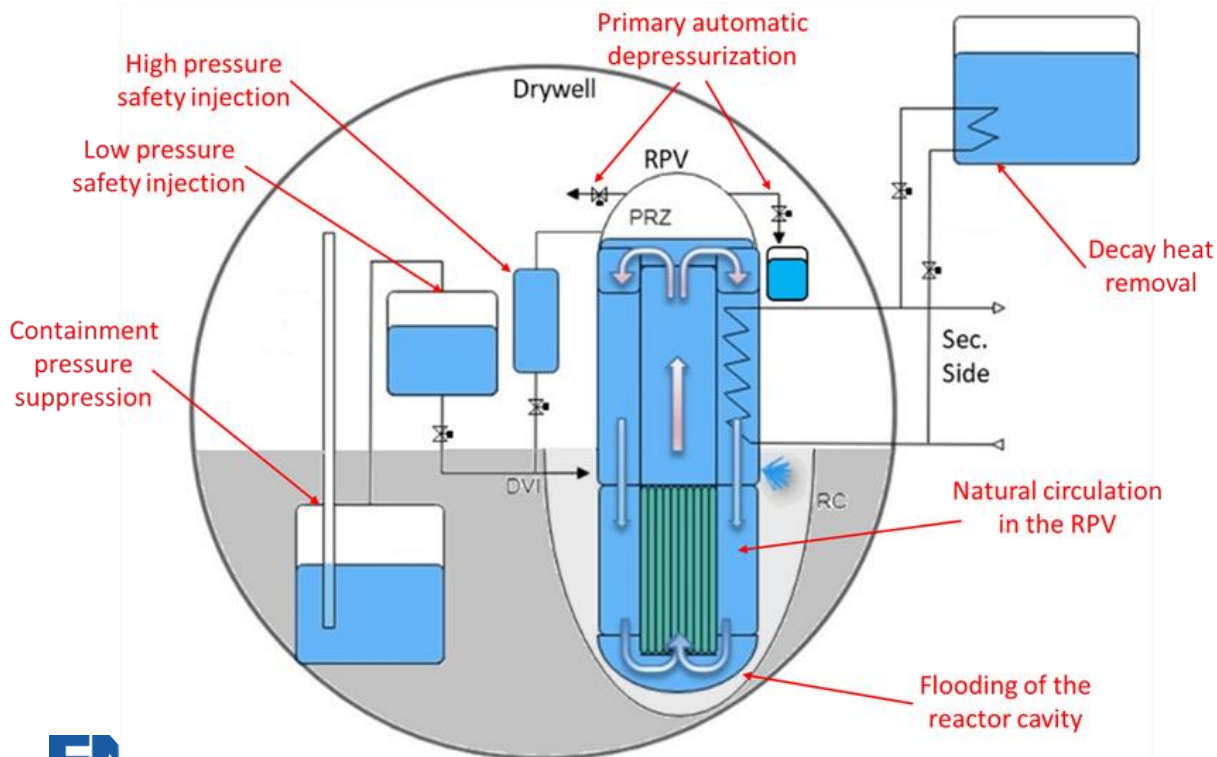

- ❑ Main geometric information has been determined by:
 - scaling the data available from the SPES-3 facility,
 - by engineering evaluation
 - public general data available for the IRIS reactor .

CVH NODALIZATION OF THE GENERIC IPWR CONSIDERED

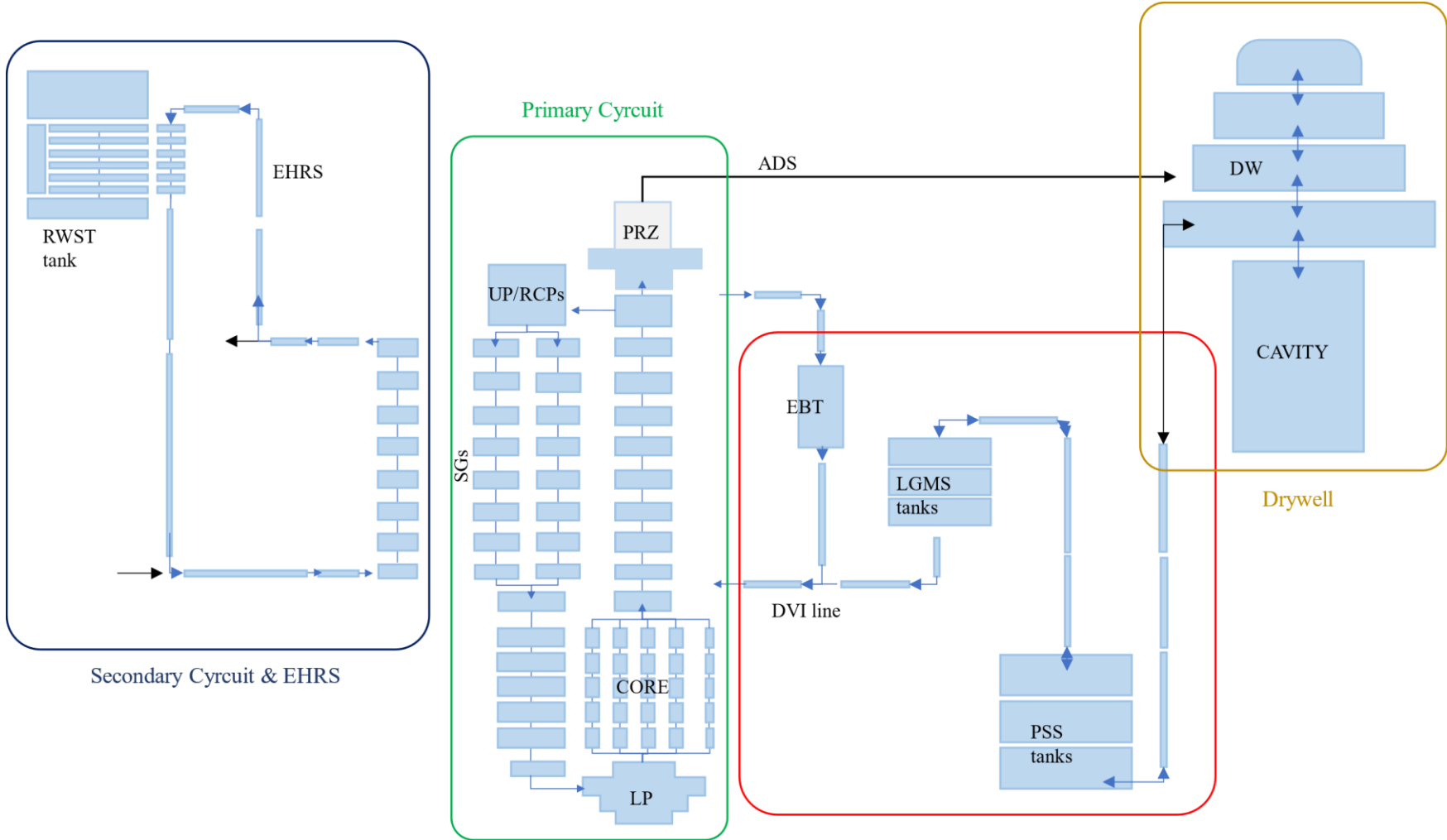

In-Containment Passive safety systems

COR PACKAGE NODALIZATION OF THE GENERIC IPWR CONSIDERED

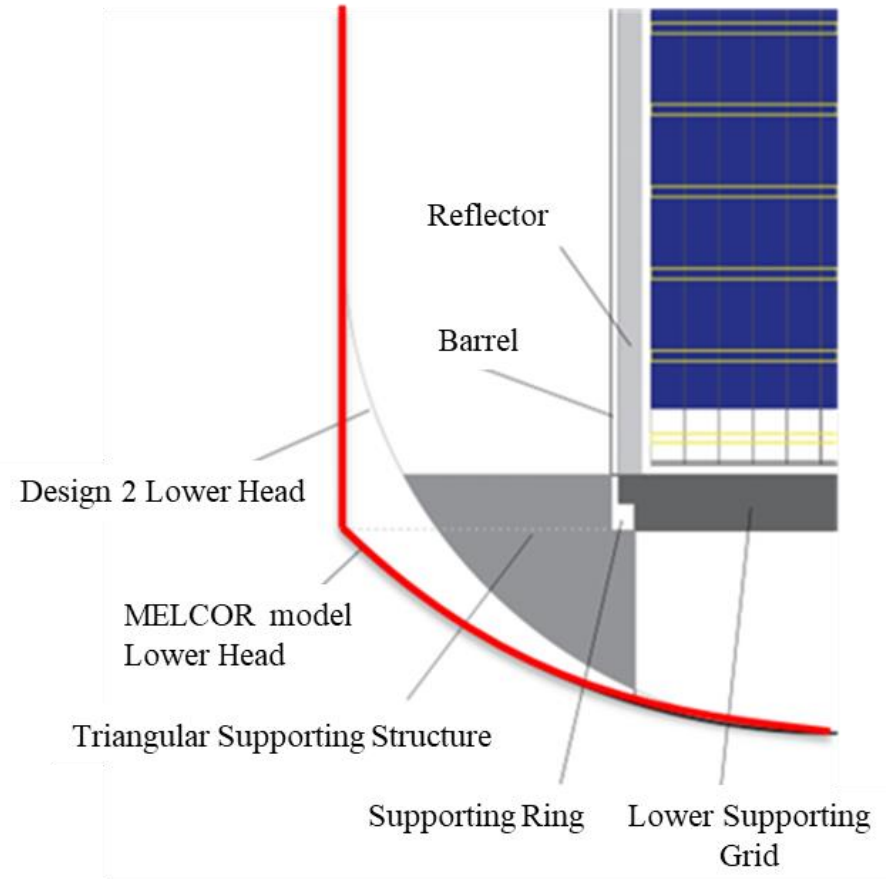
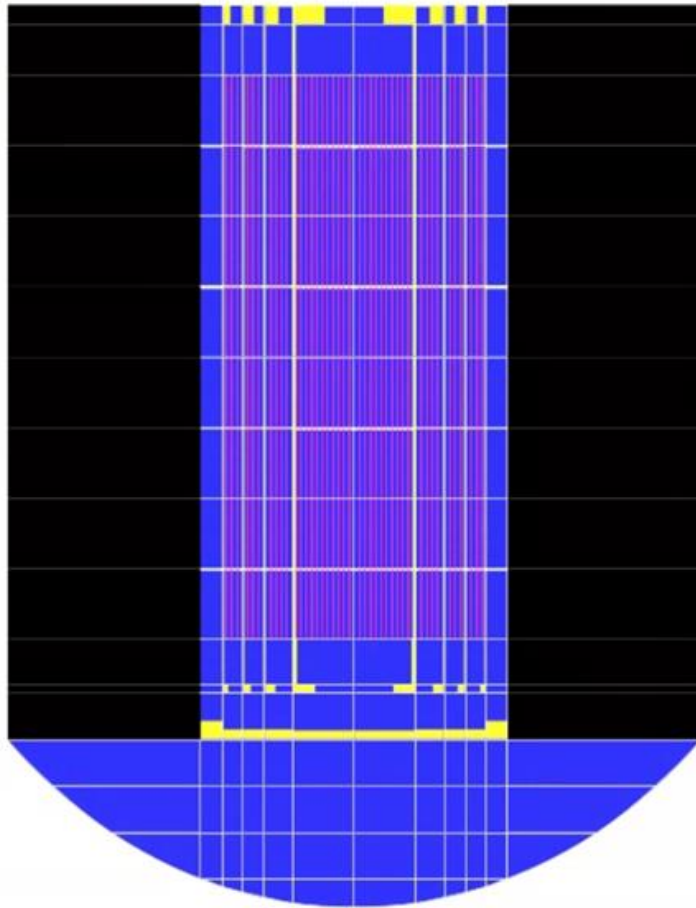

DBA PHENOMENOLOGY

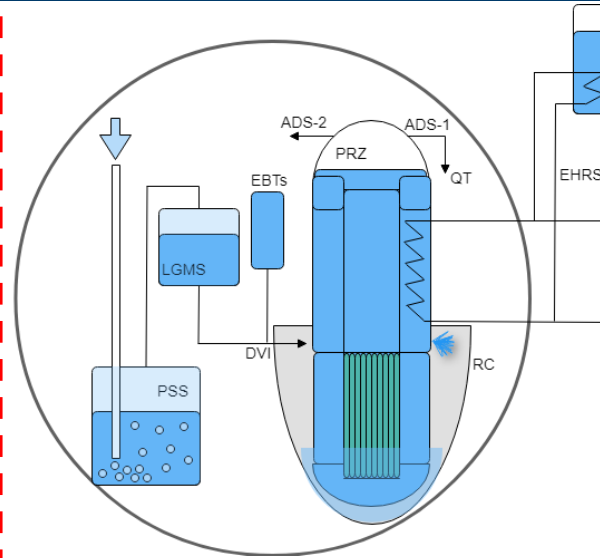
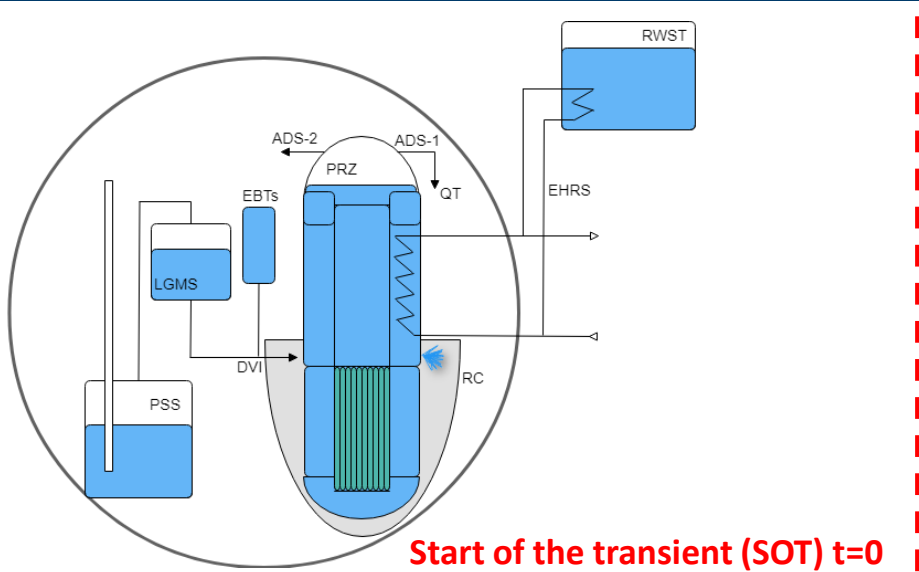

Direct Vessel Injection line (DVI) double ended break, d = 2 in

- RPV blowdown and depressurization;
- Containment pressurization.

Steam and gas dumping into the PSS-vent pipe

- PSS, LGMS pressurization.

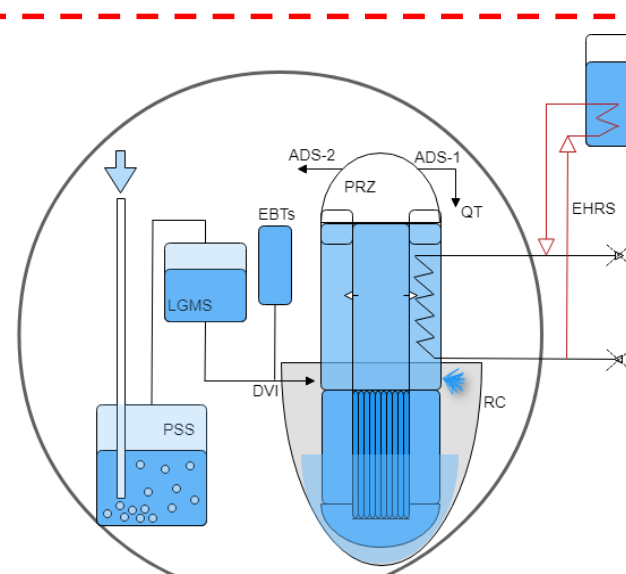
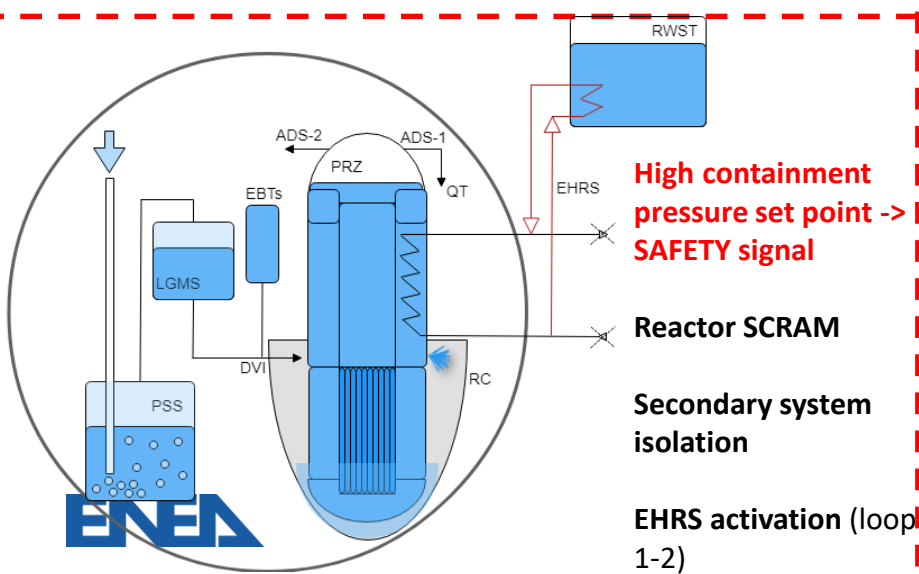

COR PACKAGE NODALIZATION OF THE GENERIC IPWR CONSIDERED

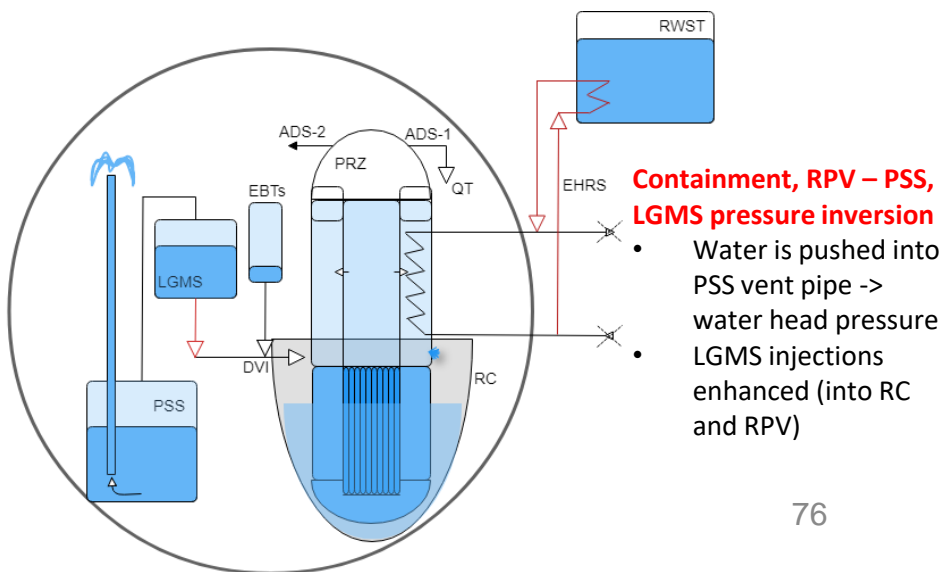
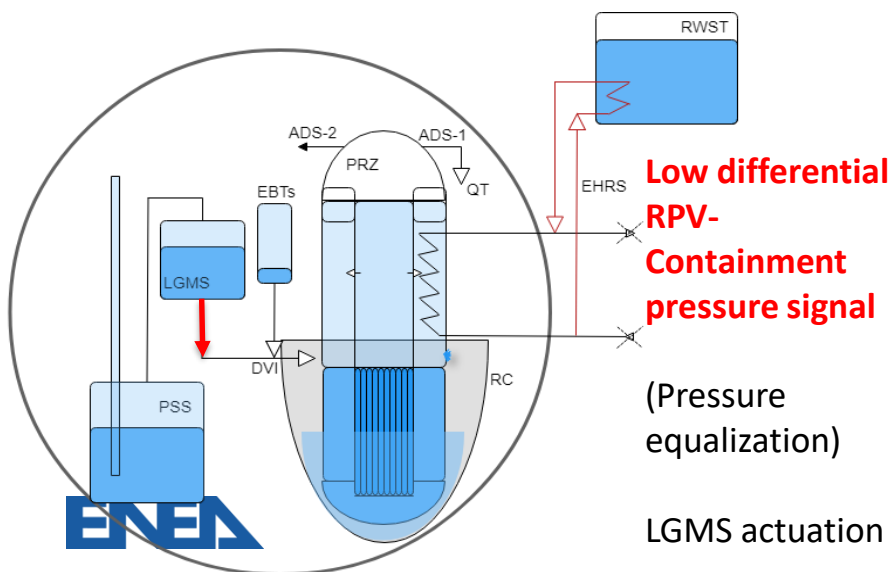
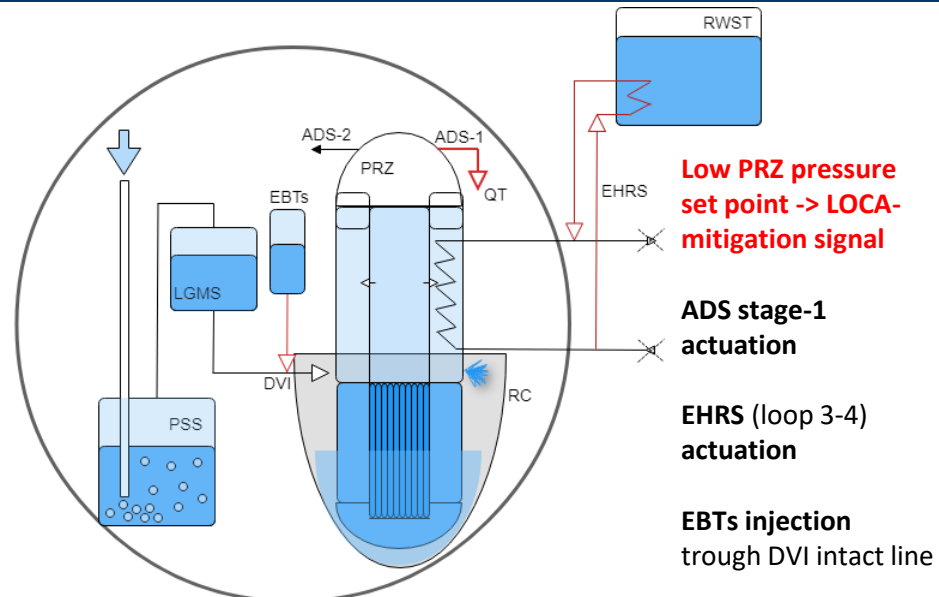
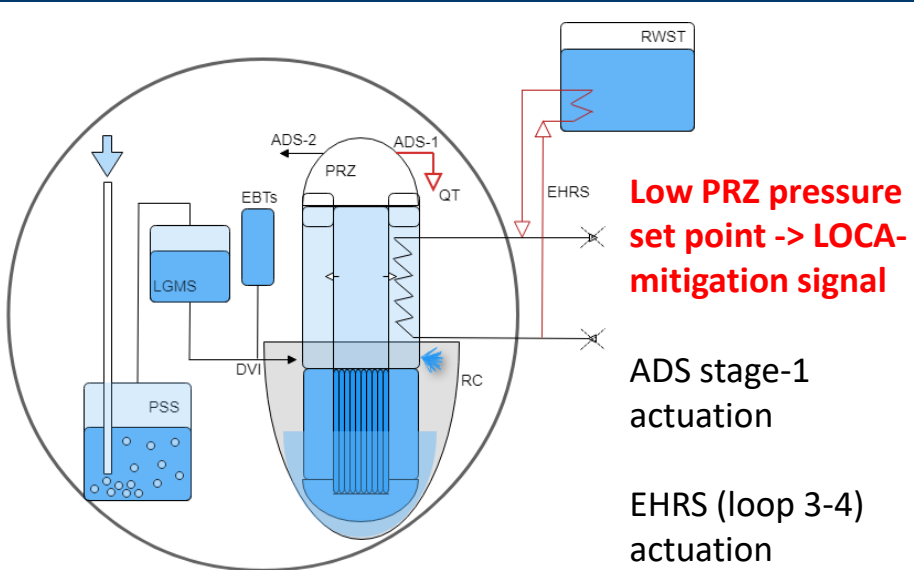

COR PACKAGE NODALIZATION OF THE GENERIC IPWR CONSIDERED

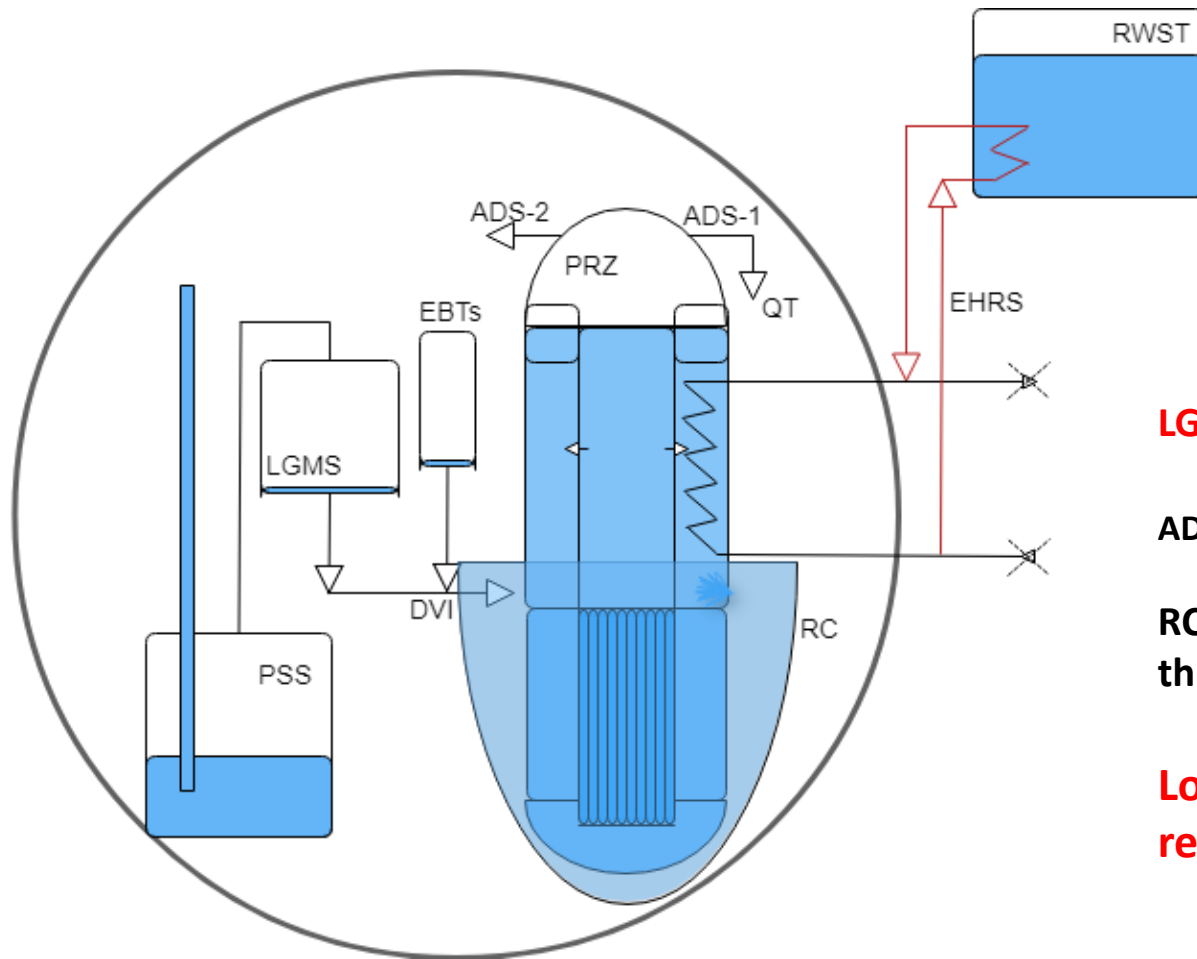

LGMS low mass signal

ADS stage-2 opening

**RC is flooded -> Reverse flow
through DVI lines into RPV**

**Long term cooling of the flooded
reactor due to EHRS**

PREDICTED PHENOMENA BY MELCOR CODE SIMULATION

System/Component	Predicted Phenomena by MELCOR simulation
RPV	Single and two-phase natural circulation; DVI break critical flow; Heat transfer in SG primary side; Heat transfer in covered and partially uncovered core
SG	Heat transfer in SG secondary side (boiling, dryout, superheating)
EHRS	Steam condensation in heat exchanger (heat transfer in tubes side); High and low pressure heat exchange in exchangers; Two-phase natural circulation
RWST	Natural convection in the pool; Thermal stratification during PhW1; Heat transfer pool side
EBT	Gravity driven injection
LGMS	Gravity and differential pressure driven injection
PSS	Influence of non-condensable gas on condensation heat transfer; Direct condensation for liquid-steam interaction; Thermal stratification
Drywell	Thermal stratification; Condensation on containment with presence of non-condensable; Heat losses to the environment; Thermal connection between RPV and Drywell
Reactor Cavity	Gravity driven injection
Quench Tank	Direct Condensation for Liquid-Steam interaction

DBA CALCULATION RESULTS

SEQUENCE OF MAIN TRANSIENT EVENTS

- ❑ SBLOCA analyzed, concerning the **double-ended break of one DVI lines**:
 - Lowest possible elevation for a LOCA and hence the most challenging accident scenario in terms of safety.
- ❑ Considering the DVI line-A as the broken line, the accident consists of 2-inch equivalent double-ended guillotine break of the DVI line.
- ❑ Availability of all the emergency passive safety systems is assumed.

Main event	Signal	Time (s)	Actuation
Double guillotine break opening	\	0	
High containment pressure set point	HCP signal, S-Signal	52	SCRAM; Secondary syst. isolation; EHRS
Low pressurizer level set point	LPL signal	93	RCPs coast-down
	(HCP + LPL)	108	Shroud RI-DC valves open
Low pressurizer pressure set point	LPP signal	165	
	LM signal (HCP + LPP)	170	EBT line opening
		173	ADS stage-1 opening
EBT-A emptying	\	1120	
Low differential pressure RV-Containment	LDPC signal	1386	LGMS starts to inject
Reverse flow PSS-DW	\	2712	
EBT-B emptying	\	3960	
Low LGMS mass set-point	LCC signal	24689	ADS stage 2
LGMS-A emptying	\	34240	
Flow from RC to RPV	\	37480	
LGMS-B emptying	\	55090	

DBA CALCULATION RESULTS

Mass flow rate through break

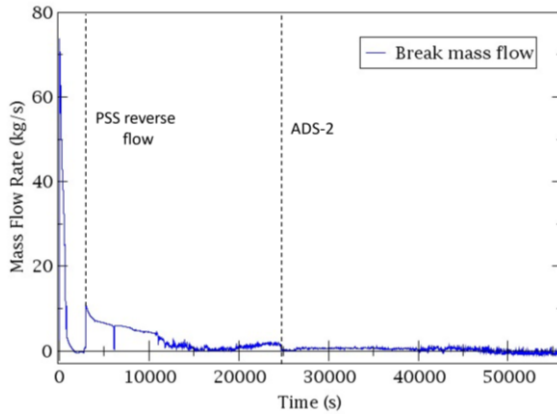

Pressure evolution in PRZ secondary system and DW

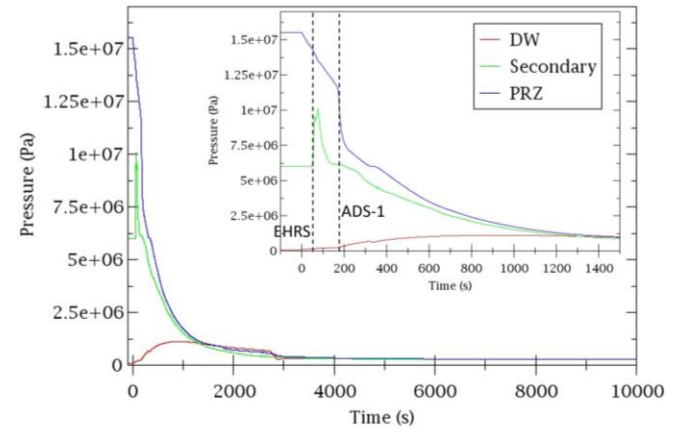

Mass flow rate through the RI-DC check valves

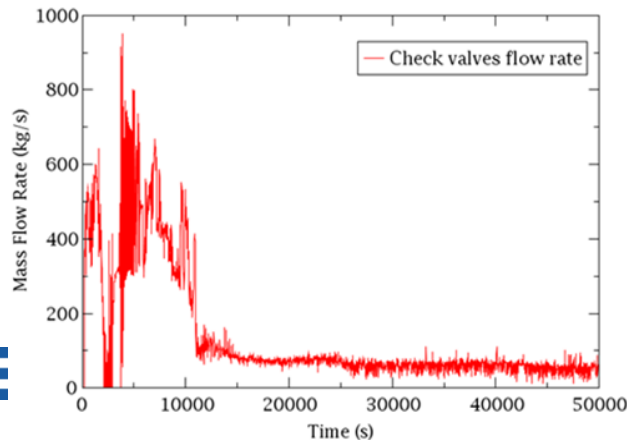

Decay heat, SGs power from RPV to EHRIS loops, power from EHRIS to RWST

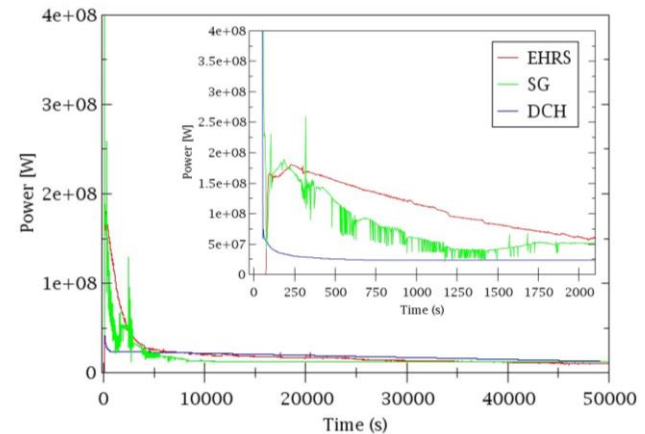

DBA CALCULATION RESULTS

Normalized water level inside the tanks of LGMS (A and B), EBT (A and B) and reactor cavity.

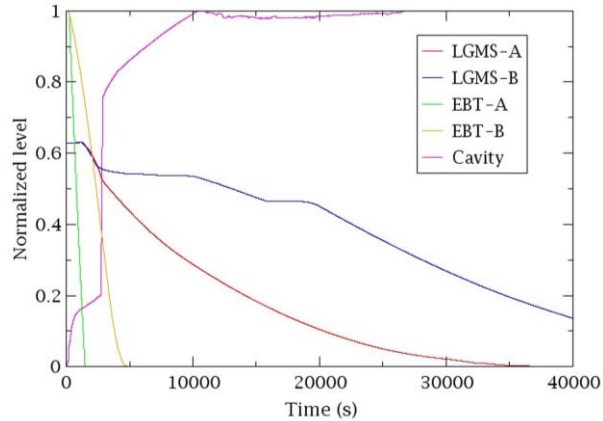

Mass flow rate through the broken DVI (to the RC) and the intact DVI (to RPV).

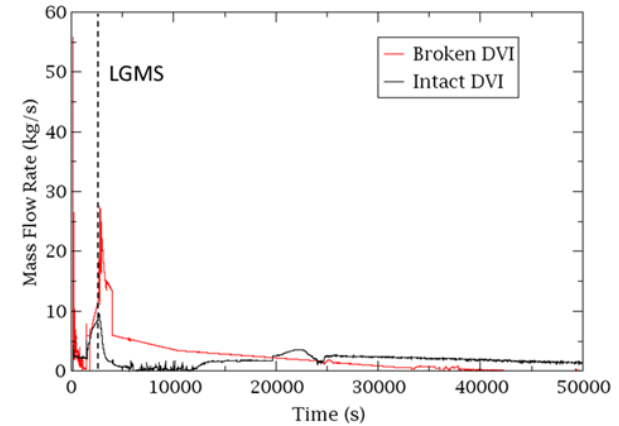

Normalized levels inside the core channels (between upper and lower nozzle grids).

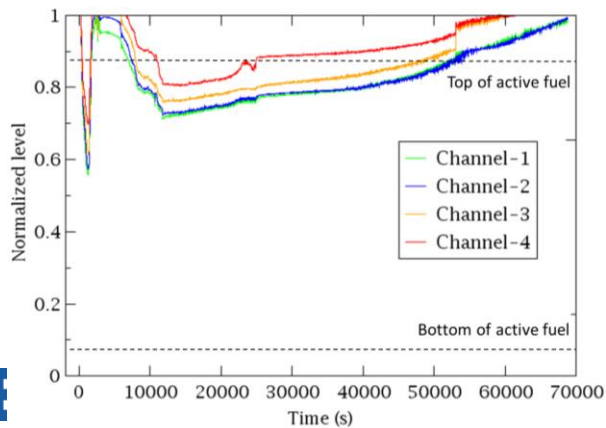

Temperature of cladding, EHRS hot leg, outlet of core and RWST

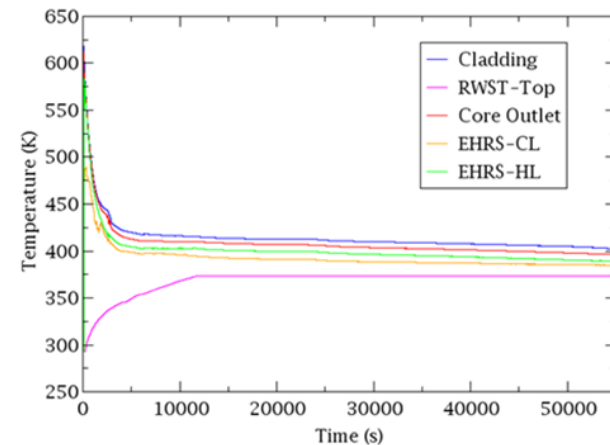

FIRST CONCLUSIONS

- ❑ The present SMR accident analysis, developed in the SASPAM-SA Horizon Euratom project, provided interesting information about the **MELCOR integral code capability to simulate the associated DBA transient phenomena in a SMR using a passive mitigation strategy**, as starting point for future postulated plausible BDBA and severe accident sequences.
- ❑ The overall **accident evolution is in accordance with the expected plant behavior and the phenomenological windows are reproduced**.
- ❑ The MELCOR model was able **to reproduce the reference steady state conditions**.
- ❑ Analyzing the simulation results of the DBA transient it can be concluded that the code can simulate:
 - **Thermal-hydraulic coupling between containment and the RPV,**
 - **Passive safety systems.**

this permits the passive mitigation strategy of the reactor, leading to the RPV depressurization and core cooling in safety conditions.

FIRST CONCLUSIONS

- ❑ The **specific phenomena that take place in the different passive systems** are predicted, e.g.:
 - Steam condensation in heat exchanger,
 - Natural convection in the pool;
 - Thermal stratification in passive system

- ❑ The **phenomenology predicted by MELCOR** are consistent with other studied presented in public literature.

- ❑ In order to **assess quantitatively the result a validation activity against selected phenomena is necessary.**

- ❑ Further derivative activities focused on assessing the capability of MELCOR code to simulate the phenomena taking place in postulated plausible severe accident scenarios in iPWR are planned.

HORIZON EURATOM SASPAM-SA PROJECT



Acknowledgement/Disclaimer

SAFETY ANALYSIS OF SMR WITH PASSIVE
MITIGATION STRATEGIES - SEVERE ACCIDENT



**Funded by the
European Union**

Funded by the European Union. Views and opinions expressed are however those of the author(s) only and do not necessarily reflect those of the European Union or European Commission-Euratom. Neither the European Union nor the granting authority can be held responsible for them.

Follow SASPAM-SA on :

<https://www.linkedin.com/company/saspam-sa-horizon-euratom-project/>

Discover more:

<https://ec.europa.eu/info/funding-tenders/opportunities/portal/screen/opportunities/projects-details/43298916/101059853/EURATOM2027>

<https://www.etson.eu/node/290>

ENEA ACTIVITIES IN THE FRAMEWORK OF IAEA CRP I31033

ENEA ACTIVITIES IN THE FRAMEWORK OF IAEA CRP I31033

- ❑ In the framework of the IAEA CRP “Advancing the State-of-Practice in Uncertainty and Sensitivity methodologies for Severe Accident Analysis in Water-cooled reactors”, a MELCOR input-deck of the QUENCH-06 has been developed.

- ❑ Goals of the activity are:
 - Independent user validation of Core Heat up, Zircaloy-Steam Oxidation and Degradation models embedded into best estimate MELCOR code employing the experimental dataset provided by QUENCH-06 test;
 - Sensitivity analysis (SA) adopting several Zircaloy-Steam oxidation reaction rates;
 - Uncertainty analysis (UA).

- ❑ A dedicated presentation has been done during the EMUG22.

The activity has been done in collaboration with Politecnico di Milano.

ENEA ACTIVITIES IN THE FRAMEWORK OF IAEA CRP I31033

TEST Control Volumes (CV)

CVH_05: : CV in correspondence of upper Mo electrode.
 • Post FWI Argon mass flow rate source

CVH_04: : CV in correspondence of upper Mo electrode

CVH_31-38: : CVs in active region

CVH_02: : CV in correspondence of lower Mo electrode

CVH_01: CV in correspondence of Cu electrode
 • Steam, Argon and quenching water flow rates sources

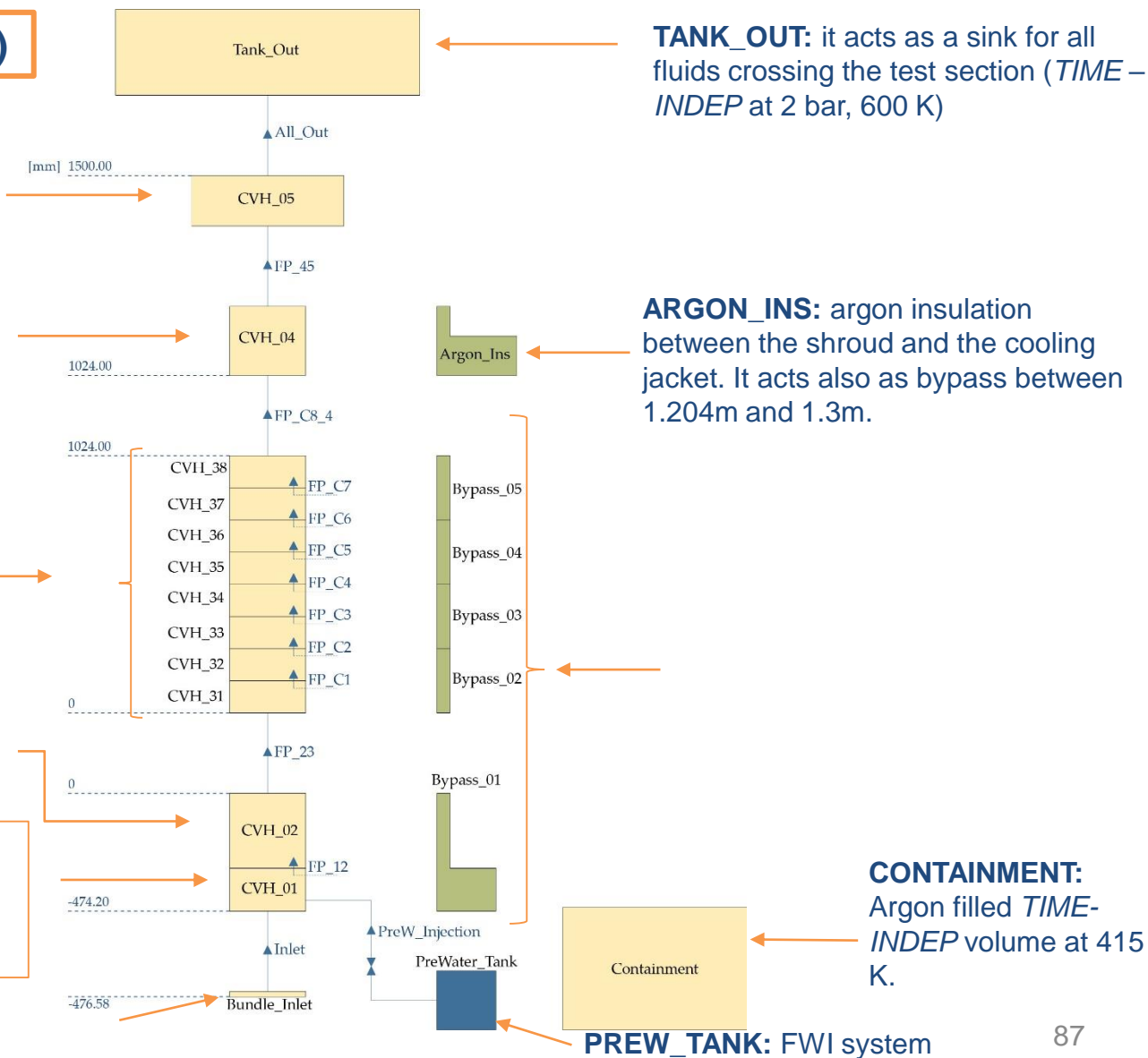

TANK_OUT: it acts as a sink for all fluids crossing the test section (*TIME – INDEP* at 2 bar, 600 K)

ARGON_INS: argon insulation between the shroud and the cooling jacket. It acts also as bypass between 1.204m and 1.3m.

CONTAINMENT: Argon filled *TIME- INDEP* volume at 415 K.

PREW_TANK: FWI system

ENEA ACTIVITIES IN THE FRAMEWORK OF IAEA CRP I31033

Test Bundle up to zircaloy shroud is nodalized in 4 concentric rings and 42 axial levels.

RADIAL NODALIZATION

- **Ring 1:** unheated rod + grids
- **Ring 2:** 8 inner heated rods + grids
- **Ring 3:** 12 outer heated rods + grids
- **Ring 4:** 4 corner rods + grids + shroud

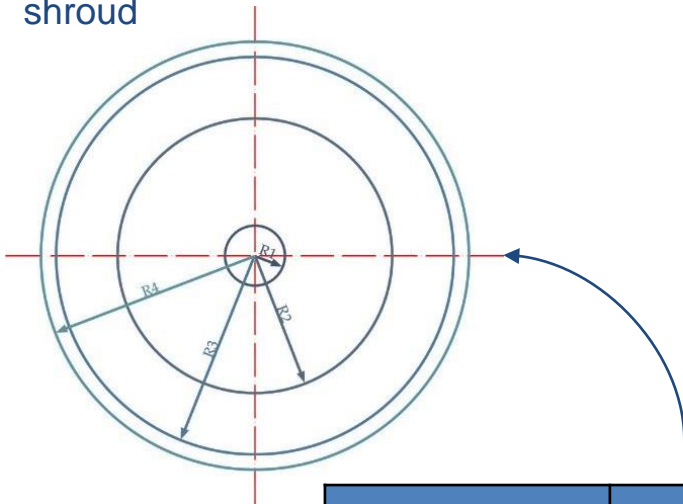

Ring	Radius
Ring #1	6 mm
Ring #2	27.975 mm
Ring #3	39 mm
Ring #4	42.38 mm

AXIAL NODALIZATION

- **Axial level 1:** lower head (dummy)
- **Axial level 2:** occupied by core supporting plate
- **Axial level 3-42:** QUENCH-06 test bundle

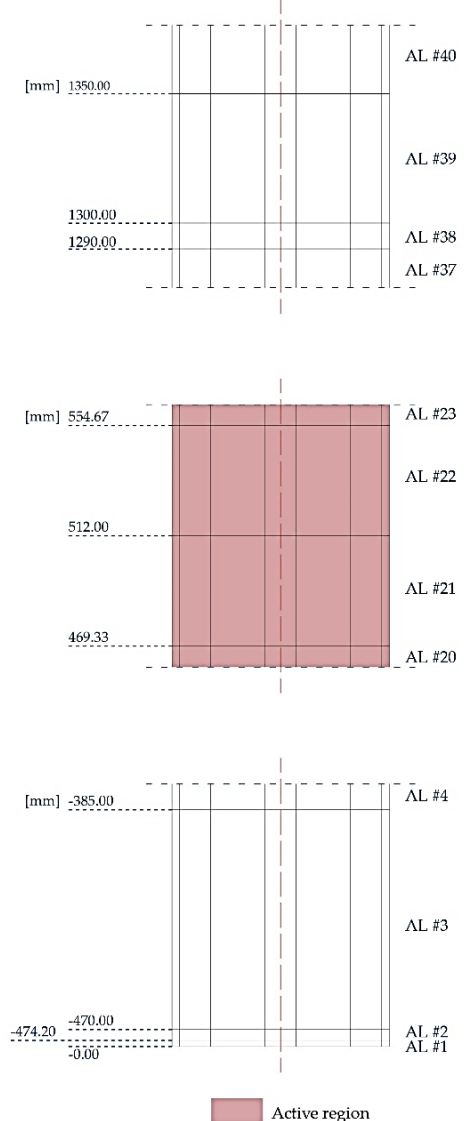
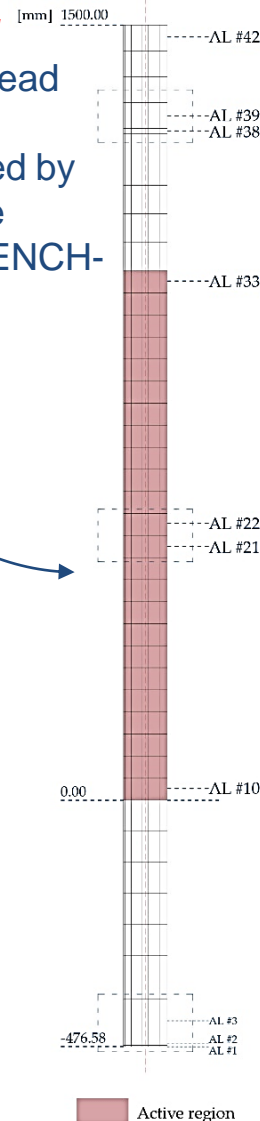

ENEA ACTIVITIES IN THE FRAMEWORK OF IAEA CRP I31033

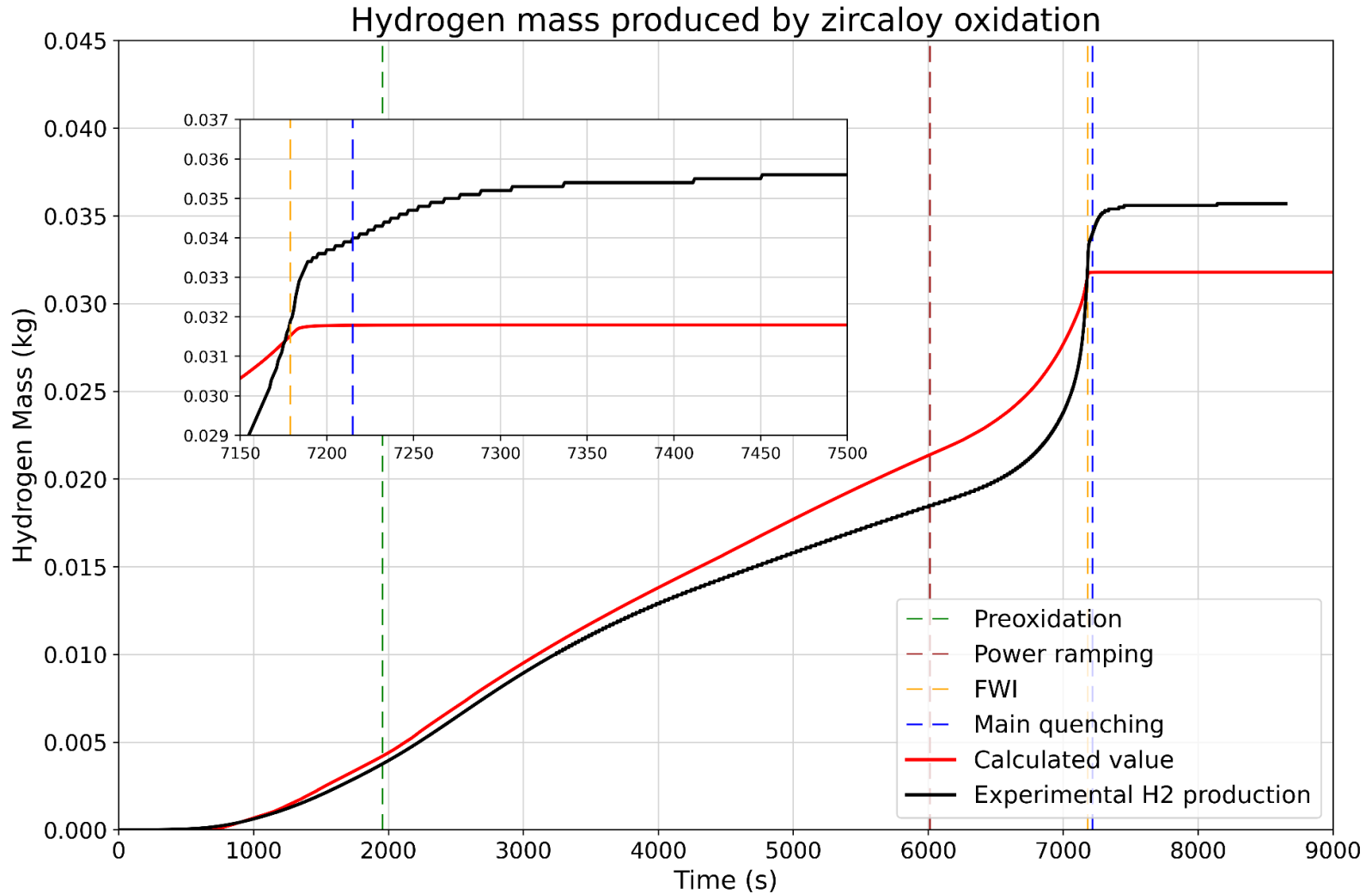

ENEA ACTIVITIES IN THE FRAMEWORK OF IAEA CRP I31033

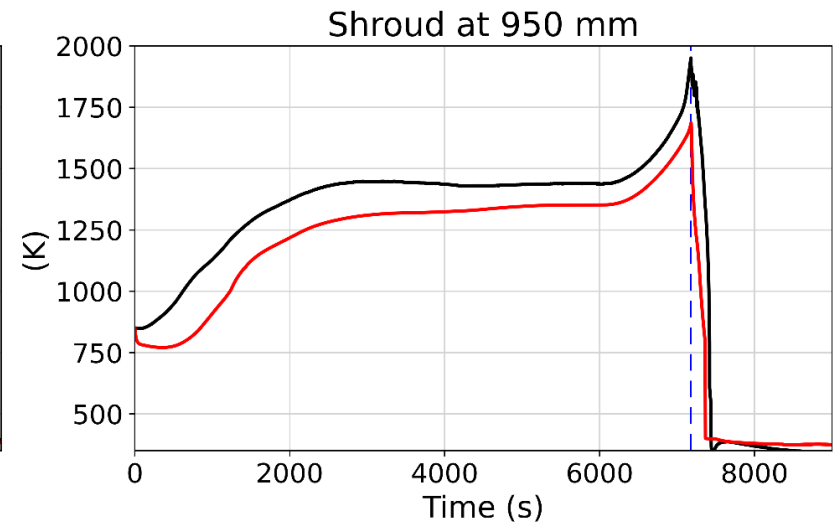
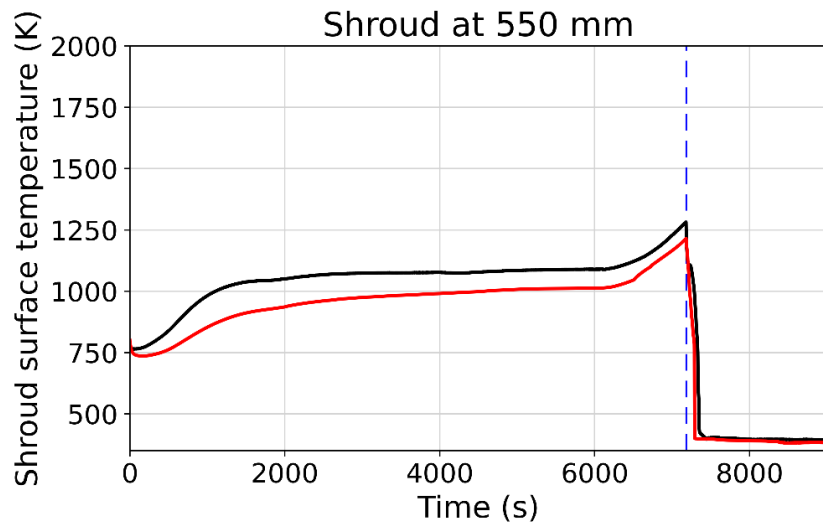
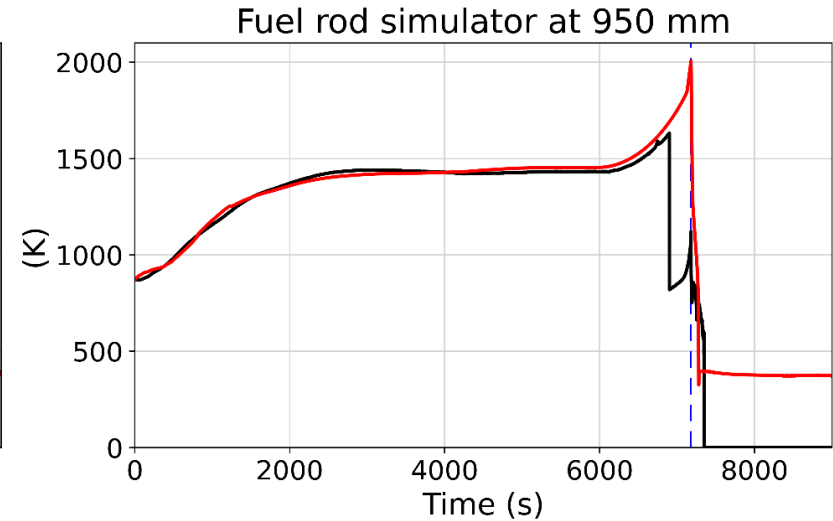
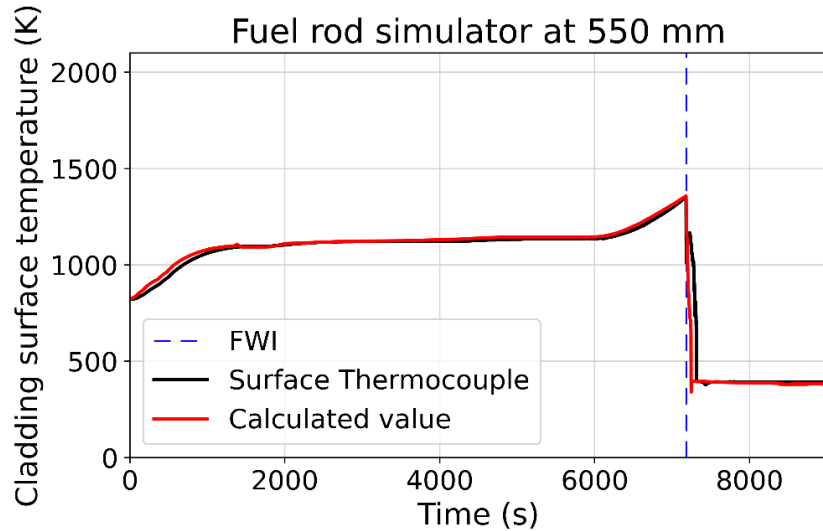

ENEA ACTIVITIES IN THE FRAMEWORK OF IAEA CRP I31033

SENSITIVITY ANALYSIS

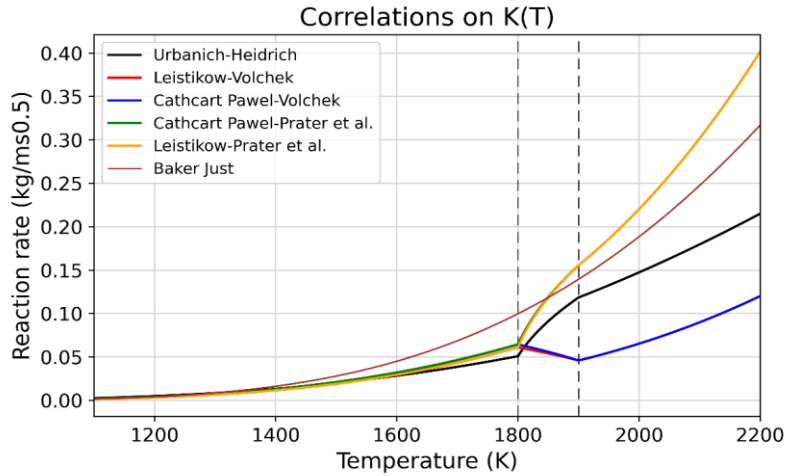

UNCERTAINTY ANALYSIS

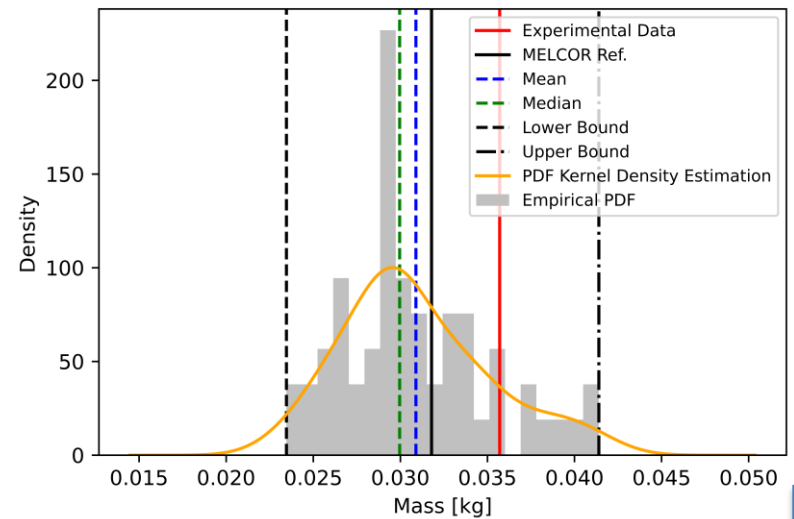
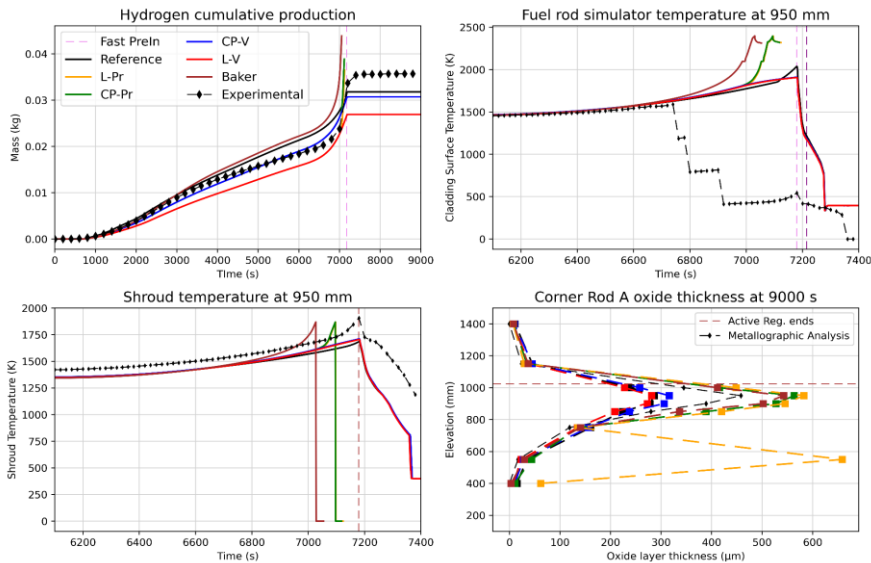
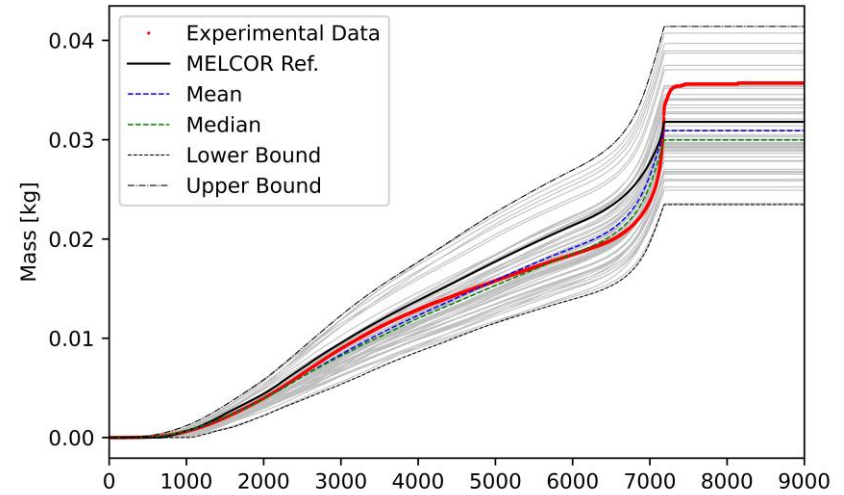

*THANK YOU FOR YOUR
KIND ATTENTION*

PUBLICATIONS

- ❑ *F. Giannetti, F. Mascari, L. Gramiccia, A. Naviglio, F. De Rosa, “Station Blackout Transient Analysis for a PWR Like Design by Using the MELCOR Code”, 32nd UIT Heat Transfer Conference, Pisa, June 23-25, 2014*
- ❑ *L.E. Herranz, M. Garcia, L. Lebel, F. Mascari, C. Spengler, In-containment source term predictability of ASTEC-Na: Major insights from data-predictions benchmarking, Nuclear Engineering and Design 320 (2017) 269–281*
- ❑ *M. Pescarini, F. Mascari, D. Mostacci, F. De Rosa, C. Lombardo, F. Giannetti, Analysis of Unmitigated Large Break Loss of Coolant Accidents using MELCOR Code, 35th UITHeat Transfer Conference (UIT2017), IOP Conf. Series: Journal of Physics: Conf. Series923 (2017) 012009.*
- ❑ *F. Mascari, M. Donorio, F. Giannetti, G. Caruso, A. Naviglio, Analisi di Transitori non Mitigati: Perdita di Refrigerante da Piccola Rottura in PWR, Perdita D’acqua di Alimento del GV in PWR e SBO in BWR ADPFISS-LP1- 103, Italy, 2017.*
- ❑ *F. Mascari, Marco Pescarini, F. Giannetti, I. Luciani, G. Caruso, Integral Calculations of Severe Accident Scenarios in PWRs and BWRs, ADPFISS-LP1-075, Italy, 2016.*
- ❑ *C. Lombardo, F. Mascari, P. Buffa, F. Castiglia, M Giardina, G. Palermo, Nodalizzazione MELCOR per lo Studio Integrale di Sequenze Incidentali su Reattori PWR da 900 Mwe e Valutazioni Preliminari D’impatto a Breve e Medio Raggio ADPFISS-LP1-026, Italy,2014.*

PUBLICATIONS

- ❑ *F. Mascari, Source term evaluation with melcor code in the eu-fastnet project framework, The 10th Meeting of the “European MELCOR User Group” Faculty of Electrical Engineering and Computing (FER), University of Zagreb, Unska 3 Zagreb, Croatia, 25th-27th April, 2018.*
- ❑ *F. Mascari, A. Guglielmelli, J. C. de la Rosa Blul, Analysis of a postulated 2-inch Cold Leg LOCA severe accident in a PWR-like 900 MWe with MELCOR code, Proceedings of 27th International Conference Nuclear Energy For New Europe - NENE 2018, Slovenia, 10-13 September, 2018.*
- ❑ *M. D’Onorio, F. Giannetti, F. Mascari, G. Caruso, uncertainty analyses using the RAVEN software tool coupled with MELCOR severe accident code, ANS Best Estimate Plus Uncertainty International Conference (BEPU 2018) BEPU2018-282 Real Collegio, Lucca, Italy, May 13-19, 2018*
- ❑ *F. Mascari, F. Rocchi P. Carny, L. Liptak, M. Adorn, J. Fontanet, L.E. Herranz, M. Shawkat, W. Raskob, F. Cousin, J. C. de la Rosa Blul, E. Urbonavicius, F. Di Dedda, T. Augustsson, M. Constantin, G. Arbaev, P. Isaksson, J. Kubicek, FASTNET SCENARIOS DATABASE DEVELOPMENT AND STATUS, The 9th European Review Meeting on Severe Accident Research (ERMSAR 2019), Clarion Congress Hotel, Prague, Czech Republic, March 18-20, 2019*

PUBLICATIONS

- ❑ *S. Ederli, F. Mascari, ASTEC simulation of In Vessel Retention Strategy applied to a generic PWR 900 Mwe, The 9TH European Review Meeting on Severe Accident Research (ERMSAR2019), Prague, Czech Republic, March 18-20, 2019.*
- ❑ *F. Mascari, S. Ederli, ANALYSES WITH MELCOR CODE OF AN UNMITIGATED SBO SCENARIO WITH IN VESSEL RETENTION STRATEGY APPLIED TO A GENERIC PWR 900 MWE, NURETH-18, 18th International Topical Meeting on Nuclear Reactor Thermal Hydraulics, NURETH 2019 2019, Pages 2497-2510*
- ❑ *F. Mascari, J. C. De LA Rosa Blul, M. Sangiorgi, G. Bandini, ASTEC, MAAP and MELCOR Benchmark Code Analysis of an Unmitigated SBO Transient in a PWR-900Like Reactor, INTERNATIONAL ATOMIC ENERGY AGENCY, Status and Evaluation of Severe Accident Simulation Codes for Water Cooled Reactors, IAEA-TECDOC-1872, IAEA, Vienna (2019).*
- ❑ *A. Bersano, F. Mascari, Evaluation of a Double-Ended Guillotine LBLOCA Transient in a Generic Three-Loops PWR-900 with TRACE Code Coupled with DAKOTA Uncertainty Analysis, ATW - Int. J. Nucl. Power 11/12 (2019) 526–532.*

PUBLICATIONS

- ❑ *F. Mascari, J. C. De La Rosa Blul, M. Sangiorgi, G. Bandini, Analyses of an Unmitigated Station Blackout Transient in a Generic PWR-900 with ASTEC, MAAP and MELCOR Code, NUREG/IA-0515, U.S. Nuclear Regulatory Commission 2019*
- ❑ *F. Mascari, M. Adorni, S. Ha; D'Ovidio, F.M. Fuertes; B. Gonfiotti, X.Z. Jin, G. Mazzini, G. Georgiev, M. Leskovar, C. Bertani, A. Bersano, F. Giannetti, D. Martelli, S. Paci, PHYSICAL MODELS NECESSARY TO BE IMPLEMENTED IN MELCOR_2.2 FOR FUSION REACTOR SAFETY ANALYSES AND THE CURRENT MODEL ALREADY IMPLEMENTED IN MELCOR FUSION, 1th Meeting of the European MELCOR and MACCS User Group Paul Scherrer Institute, Villigen, Switzerland, April 3-5, 2019*
- ❑ *A. Bersano, F. Mascari, M.T. Porfiri, P. Maccari, C. Bertani, Ingress of Coolant Event simulation with TRACE code with accuracy evaluation and coupled DAKOTA Uncertainty Analysis, Fusion Engineering and Design 159 (2020) 111944*
- ❑ *Pietro Maccari, Sandro Manservigi, Fulvio Mascari, Stefano Ederli, SBO ANALYSES OF A GENERIC PWR-900 WITH ASTEC AND MELCOR CODES, Journal of Physics: Conference Series 1868 (2021) 012019 doi:10.1088/1742-6596/1868/1/012019*

PUBLICATIONS

- ❑ *G. Agnello, P. A. Di Maio, A. Bersano, F. Mascari, COLD LEG LBLOCA UNCERTAINTY ANALYSIS USING TRACE/DAKOTA COUPLING, Journal of Physics: Conference Series 2177 (2022) 012023 doi:10.1088/1742-6596/2177/1/012023*
- ❑ *G. Agnello, S. Ederli, P. Maccari, F. Mascari, ANALYSIS OF AN UNMITIGATED 2-INCH COLD LEG LOCA TRANSIENT WITH ASTEC AND MELCOR CODES, Journal of Physics: Conference Series 2177 (2022) 012024 doi:10.1088/1742-6596/2177/1/012024*
- ❑ *A. Bersano, G. Agnello, P. A. Di Maio, F. Mascari, TRACE QUALIFICATION FOR INGRESS OF COOLANT EVENT AND DAKOTA UNCERTAINTY ANALYSIS, paper presented at the 19th International Topical Meeting on Nuclear Reactor Thermal Hydraulic (NURETH-19).*
- ❑ *A. Bersano, G. Agnello, F. D'Auria, E. Zio, F. Mascari, METHODOLOGY AND APPLICATION TO CHARACTERIZE THE SUMP CLOGGING ISSUE IN CASE OF LONG-TERM CORE COOLING, paper presented to the RCCS-2021-OECD/NEA Specialist Workshop on Reactor core cooling and containment cooling systems, 18-20 October 2021.*

PUBLICATIONS

- ❑ *F. Mascari et al., First outcomes from the Phebus FPT1 uncertainty application done in the EU-MUSA Project, paper presented at the 19th International Topical Meeting on Nuclear Reactor Thermal Hydraulic (NURETH-19).*
- ❑ *F. Mascari, M. Massone, G. Agnello, M. Angelucci, S. Paci, M. D'Onorio, F. Giannetti, Phebus FPT1 uncertainty application with the MELCOR 2.2 code, paper presented at the 19th International Topical Meeting on Nuclear Reactor Thermal Hydraulic (NURETH-19).*
- ❑ *F. Giannetti, M. Imperatori, M. D'Onorio, M. Garcia, L. E. Herranz, Analyses of the MELCOR capability to simulate integral PWR using passive systems, NURETH-20*

Fulvio Mascari:
fulvio.mascari@enea.it

