

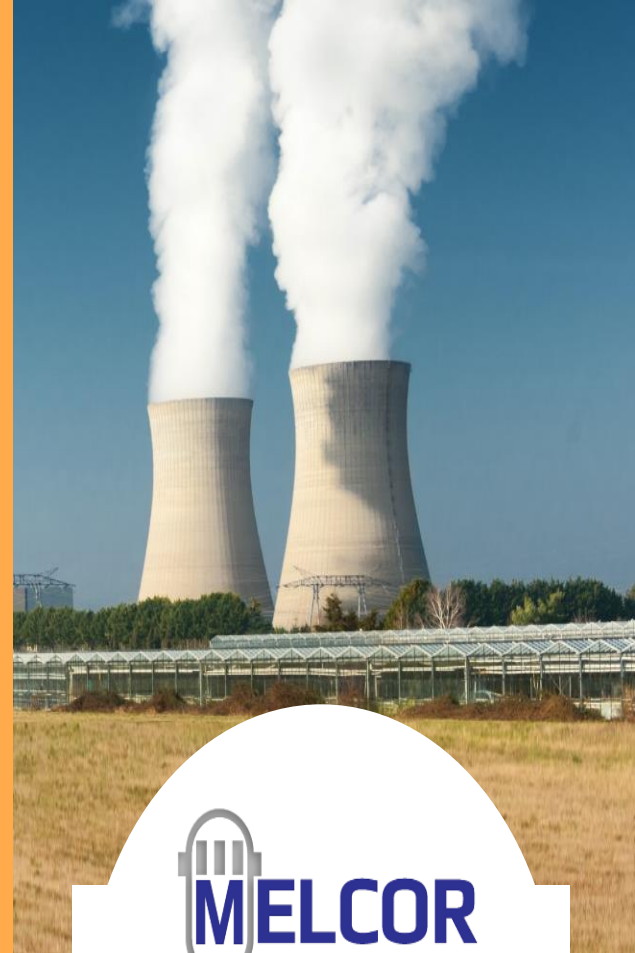

Securing the future of Nuclear Energy



Fission Product & Radionuclide Release

2024 European MELCOR Users' Group Meeting

April 15th-18th, 2024



SAND2024-03307C



Sandia National Laboratories is a multission laboratory managed and operated by National Technology and Engineering Solutions of Sandia, LLC., a wholly owned subsidiary of Honeywell International, Inc., for the U.S. Department of Energy's National Nuclear Security Administration under contract DE-NA0003525.

Overview



Review LWR and non-LWR fission product release

Four basic release models/options

- CORSOR, CORSOR-M, CORSOR-Booth, & Modified CORSOR-Booth
- Validation

Generalized release model

Specialized release models

- TRISO fuel diffusional release model
 - Metal fuel release model
 - Structural Ag-In-Cd control rod material
-

Reminder



User initializes fission product mass (sorted by radionuclide class) over core cells in fuel and/or gap (RN1_FPN/RN1_GAP)

User sets gap release conditions (RN1_GAP00)

User picks release model (RN1_FP00)

- Governs release from...
 - Intact fuel material in FU component,
 - Refrozen fuel material (as conglomerate)
 - Fuel material as other components (PD and MP)
 - Possibly structural materials as non-FU components (nonradioactive)

TRISO and metal fuel release models require other/different inputs in COR and may or may not use RN1_FP00 elections

CORSOR and CORSOR-M Models



CORSOR correlates fractional release rate [-/min] as:

$$R = Ae^{B*T}, \quad \text{for } T > T_i$$

- A and B are empirical constants, T is component temperature [K]
- T_i is a lower temperature limit
- RN1 SC 7101 for class-wise constants and limits

CORSOR-M correlates fractional release rate [-/min] as:

$$R = k_0 e^{-Q/(R*T)}$$

- k_0 [-/min] and Q [kcal/mol] differ by radionuclide class
- T is component temperature [K]
- R is $1.987 * 10^{-3} \left[\frac{\text{kcal}}{\text{mol}*K} \right]$
- RN1 SC 7102 for class-wise constants and limits

CORSOR-Booth Model



Calculate class-wise release from scaling of mass transport limited Booth model prediction for Cesium release

- Booth model
 - Approximate Fick's law solution on a sphere of radius a
 - Use Arrhenius diffusion data from Cs (RN1 SC 7106)

$$D = D_o \exp(-Q/RT)$$

$$f = 6 \sqrt{\frac{D' t}{\pi}} - 3 D' t \quad \text{for } D' t < 1/\pi^2$$

$$f = 1 - \frac{6}{\pi^2} \exp(-\pi^2 D' t) \quad \text{for } D' t > 1/\pi^2$$

where

$$\frac{D' t}{a} = Dt/a^2 \text{ (dimensionless)}$$

a = equivalent sphere radius for the fuel grain

$$\text{Release rate}_{Cs} = \frac{[(f \sum D' \Delta t)_{t+\Delta t} - (f \sum D' \Delta t)_t] V \rho}{(1-f)\Delta t}$$

- Gas phase mass transport limitation

$$\frac{1}{M_{Cs}} = \frac{D_{fuel} RT}{A_{fuel} Nu D_{k,gas} P_{k,eq}}$$

where

- D_{fuel} = diameter of fuel pellet
- A_{fuel} = fuel rod flow contact area
- $D_{k,gas}$ = diffusivity of class k in the gas mixture
- Nu = Nusselt number
- $P_{k,eq}$ = equilibrium vapor pressure of class k at temperature T

- Overall:

$$DIFF_{Cs} = \left[\frac{1}{\text{Release rate}_{Cs}} - \frac{1}{M_{Cs}} \right]^{-1}$$

$$DIFF_k = DIFF_{Cs} S_k$$

See RN1 SC 7103 & 7107

CORSOR-Booth Model



Potential underflow issue

- Quantity $\sum D' \Delta t$ increases monotonically
- Evaluate quantity $\exp(-\pi^2 D' t)$ to 0 for $\sum D' \Delta t > 5$
- Effectively halt Cs (and all RN class) release

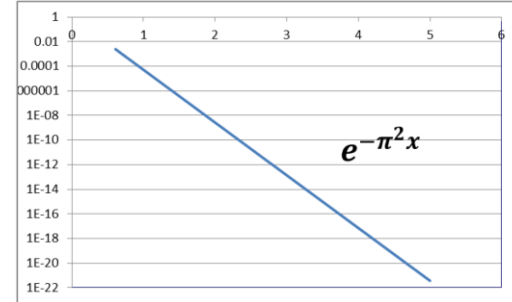

Release fraction

- MELCOR internally tracks RFRAC, the “fraction remaining” of Cs
- For a more consistent calculation, solve Booth Cs release rate as:

$$\text{Release rate}_{Cs} = \frac{[(f \sum D' \Delta t)_{t+\Delta t} - (f \sum D' \Delta t)_t] V \rho}{(1-f) \Delta t} \quad \longrightarrow \quad \text{Release rate}_{Cs} = \frac{V \rho}{(1 - RFRAC)} \frac{d(RFRAC)}{dt}$$

- Where time derivatives of RFRAC come from $f(t)$, e.g.

$$f = 1 - \frac{6}{\pi^2} \exp(-\pi^2 D' t) \quad \text{for } D' t > 1/\pi^2 \quad \longrightarrow \quad \frac{d(RFRAC)}{dt} = \pi^2 D' (1 - RFRAC), \quad \text{for } D' t > \frac{1}{\pi^2}$$

CORSOR-Booth Model



Potential issues with Booth approximation

Derivative of approximation to $f(t)$ discontinuous at $t = \frac{1}{\pi^2 D'}$

- Error ~ 50%
- Implications for fitting?
- Interpretation in calculated release?

Could use a series solution

$$f(x) = 1 - \frac{6}{\pi^2} \sum_{n=1}^{\infty} \frac{1}{n^2} e^{-n^2 \pi^2 D'}$$

- Better agreement at discontinuity (3 or 4 terms may be sufficient)
- As many as 10 terms needed for good agreement as $D't \rightarrow 0$

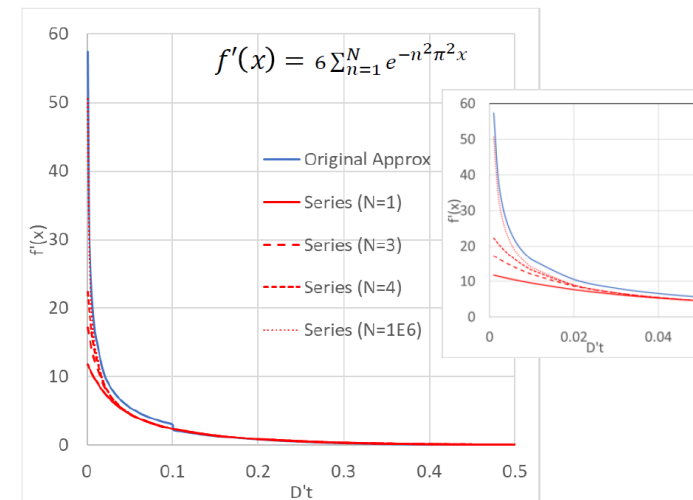
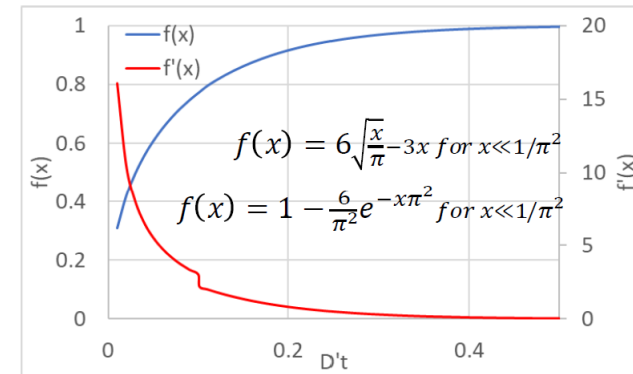

CORSOR-Booth Model



Booth scaling factors not derived for use as multipliers to the Cs release rates, thus a new Booth model was developed

New ORNL-Booth Model

- Diffusion coefficients scaled to Cs diffusion coefficients and independent diffusion calculation for each class

$$= \int_0^{D't} \frac{f'_k}{1 - f_k} \cdot (1 - f_k)$$

Existing modified ORNL-Booth Model

- Scale RN release rates to Cs Booth diffusion release rate

$$= \int_0^{D't} S_k \frac{f'_{Cs}}{1 - f_{Cs}} \cdot (1 - f_k)$$

CORSOR-Booth Model



Corrected Booth modeling with scaled diffusion coefficients

- MELCOR diffusion coefficients scaled with ORNL Data
 - $D_{class} = S_{class} D_0 e^{-\frac{Q}{RT}}$
- Perform diffusion calculation for each class using appropriate diffusion coefficient
 - ICRLSE=7,-7

Diffusion Coeff, D_0	1×10^{-6} m ² /sec
Activation Energy, Q	3.814×10^5 Joule/mole
S_{XE}	1
S_{Cs}	1
S_{Ba}	4×10^{-4}
S_I	0.64
S_{Te}	0.64
S_{Ru}	0.0025
S_{Mo}	0.2
S_{Ce}	4×10^{-8}
S_{La}	4×10^{-8}
S_{Cd}	.25
S_{Sn}	.16

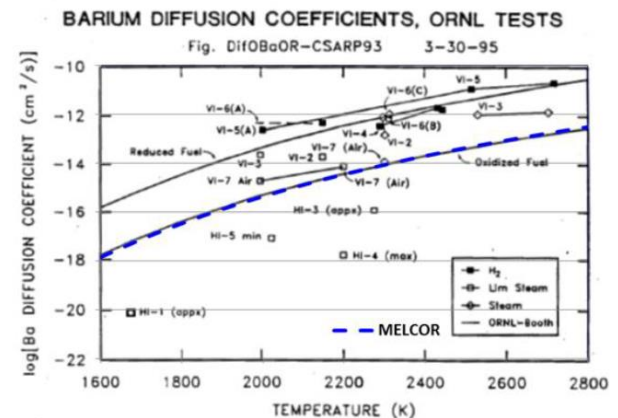
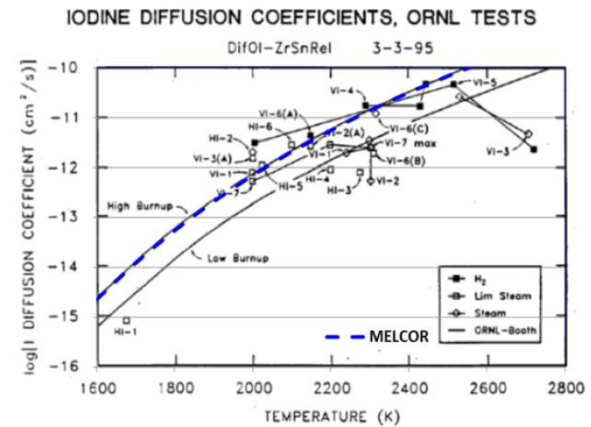

CORSOR-Booth Model



Corrected Booth modeling – validation

- Validation of model against FPT-1 experiment
 - ‘New ORNL-Booth’ (ICRLSE=-7,7) represents modeling based on scaling diffusion coefficients
 - Release is only changed for those RNs with diffusion scale factors much less than unity
 - Comparison of Barium release
 - Diffusion coefficient is orders of magnitude smaller than Cs (scale factor = 4×10^{-4})
 - Predicts larger release fraction than observed
 - » May need to be adjusted
 - Predicts much larger release fraction than ‘Revised ORNL-Booth’ (ICRLSE=-5,5) though relative error is about the same
 - Note inconsistencies in ‘Total’ and ‘Total Released’ in text output
 - » Round-off issues leads to 30% error
 - » May account for error in release fraction (in part)

RELEASED RADIOACTIVE RADIONUCLIDE MASS AUDIT - MASSES IN KG

CLASS	TOTAL	AEROSOL MASSES		VAPOR MASSES		DEP MASS	FILTERS	CHEM AB	PHYSDEP
		RELEASED	GAS LIQUID	GAS	LIQUID				
XE	2.819E-02	2.819E-02	0.000E+00	0.000E+00	2.819E-02	0.000E+00	0.000E+00	0.000E+00	0.000E+00
CS	9.708E-03	1.181E-02	0.000E+00	4.256E-03	2.224E-02	0.000E+00	5.242E-03	0.000E+00	2.095E-04
BA	4.704E-04	6.211E-04	0.000E+00	1.826E-04	0.000E+00	0.000E+00	2.878E-04	0.000E+00	0.000E+00

- Comparison of I₂ Release
 - Very Slight differences
 - Diffusion coefficient scale factor close to unity (0.65)

Barium

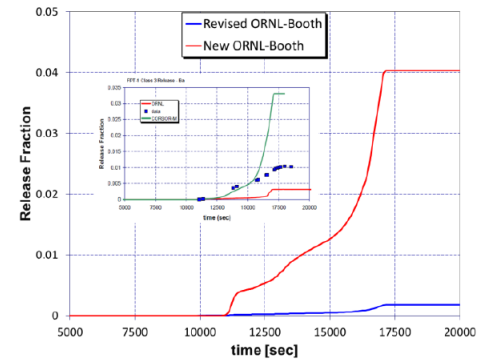

Iodine

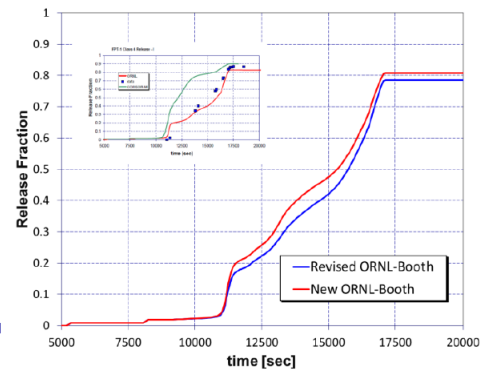

CORSOR-Booth Model



Corrected Booth modeling – gaseous mass transport

$$\dot{m}_k = \left[Nu \frac{D_{k,gas}}{D_{fuel}} \right] \cdot A_{fuel} \cdot \left(\frac{P_{k,eq}}{RT} - \rho_{k,free} \right)$$

Gas-phase mass transfer from heat transfer analogy (free stream density of all RNs assumed zero)

- CORSOR-Booth Model (ICRLSE=3,-3)
 - Mass transfer term removed from effective release rate before scaling other RNs

$$ReleaseRate_{Cs} = \frac{[f(\sum_{t+\Delta t} D' \Delta t) - f(\sum_t D' \Delta t)]}{(1-RFRAC)\Delta t} V \rho$$

$$DIFF_{Cs} = \left[\frac{1}{ReleaseRate_{Cs}} - \frac{1}{\dot{m}_{Cs}} \right]^{-1}$$

$$DIFF_k = DIFF_{Cs} \cdot S_k$$

- Revised CORSOR-Booth Model (ICRLSE=5,-5)
 - Mass transfer term not removed from Cs release rate
 - Assumes ReleaseRate only accounts for diffusion

$$DIFF_k = ReleaseRate_{Cs} \cdot S_k$$

- Mass transfer term added back to each RN $\dot{m}_k = [1/DIFF_k + 1/\dot{m}_k]^{-1}$

CORSOR-Booth Model



Gaseous mass transport relative to UO₂ in volume

- Note that RM indicates Cs release rate is fractional release multiplied by ρV
 - Where V is volume and ρ is UO₂ molar density
 - New model uses actual class inventory
- Note however that release rate is divided by ρV before multiplying by RN inventory to obtain mass released
- Even so, scaling by ρV is important in comparing diffusion release rate with gas release rate

Old Modeling

$$ReleaseRate_{Cs} = \frac{[f(\sum_{t+\Delta t} D' \Delta t) - f(\sum_t D' \Delta t)]}{(1 - RFRAC_{Cs}) \Delta t} \rho V$$

$$\dot{f}_k \text{ (fraction/s)} = \frac{\dot{m}_{tot,k}}{\rho V} \left[F - \frac{P_{k,bulk}}{P_{k,eq}} \right]$$

$$\dot{m}_k = [1/DIFF_k + 1/\dot{m}_k]^{-1}$$

New Modeling

$$ReleaseRate_{Cs} = \frac{[f(\sum_{t+\Delta t} D' \Delta t) - f(\sum_t D' \Delta t)]}{(1 - RFRAC_k) \Delta t} Mass_{k,component}$$

$$\dot{f}_k \text{ (fraction/s)} = \frac{\dot{m}_{tot,k}}{Mass_k} \left[F - \frac{P_{k,bulk}}{P_{k,eq}} \right]$$

$$\dot{m}_k = [1/DIFF_k + 1/\dot{m}_k]^{-1}$$

CORSOR-Booth Model



Strictly valid in intact fuel as release depends on history

- Release fraction for intact fuel well characterized
- No moving material associated with intact fuel
- All other components bearing fuel material only do so after a transport occurs (conglomerate or PD)
- MELCOR blends release fractions after transport (meaningful?)

Unoxidized Zr can lead to reduction in release rate of Te

- Te reacts with Zr to form low vapor pressure products
- Te release rate reduced by a multiplier until mass of unoxidized intact metal CL (Zr) falls below a cut-off fraction of total intact CL
- Parameters are SC7105 and SC7107

T. Nakamura and R. A. Lorenz, "Effective Diffusion Coefficients Calculated from ORNL FP Release Test Results," Oak Ridge National Laboratory Research Paper (April 1989).

CORSOR-Booth Model



Original CORSOR-Booth class scaling factors were modified based on ORNL-VI results

- Dominant Cs species changed from CsI to CsMoO₄
- FP releases adjusted based on Phebus-FPT1
- Results compared again to ORNL-VI and VERCORS (2 and 4)

Modified CORSOR-Booth shows improvement over original CORSOR-Booth generally

Phebus Test Facility

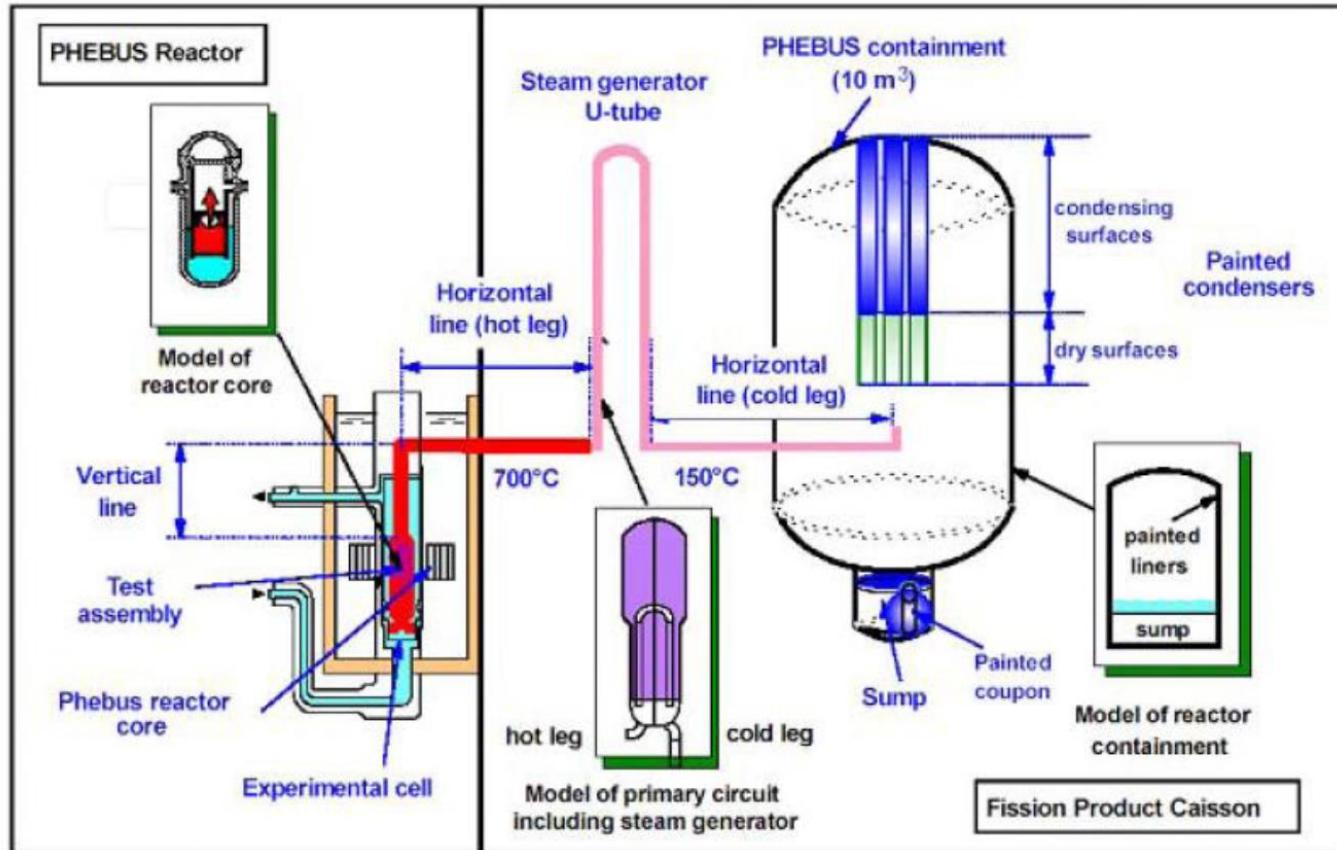

Phebus-FPT1 Cs

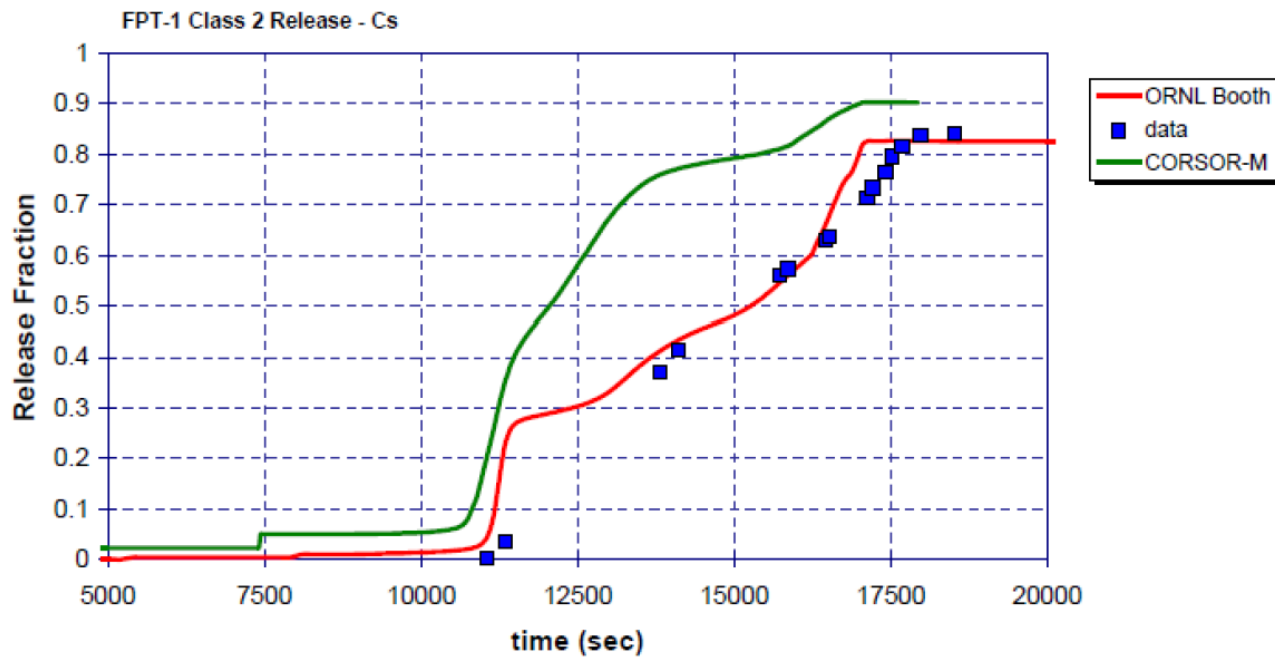

Phebus-FPT1 Other Classes

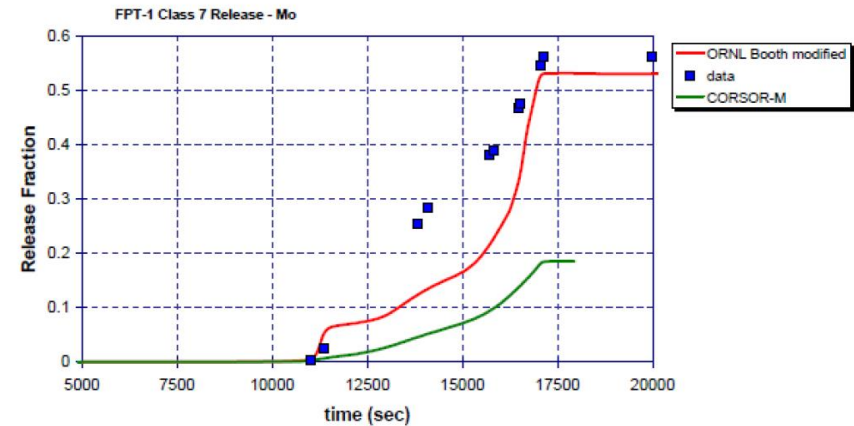
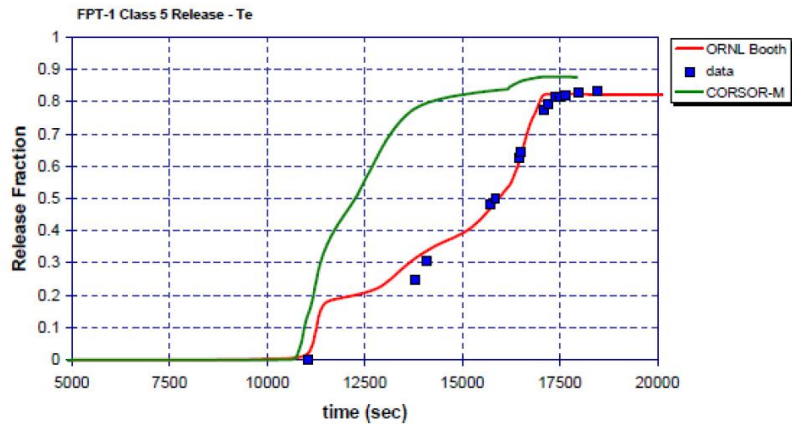
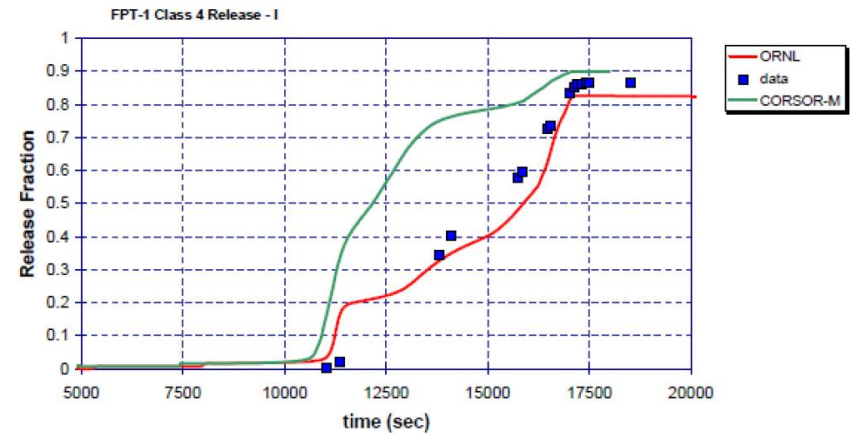
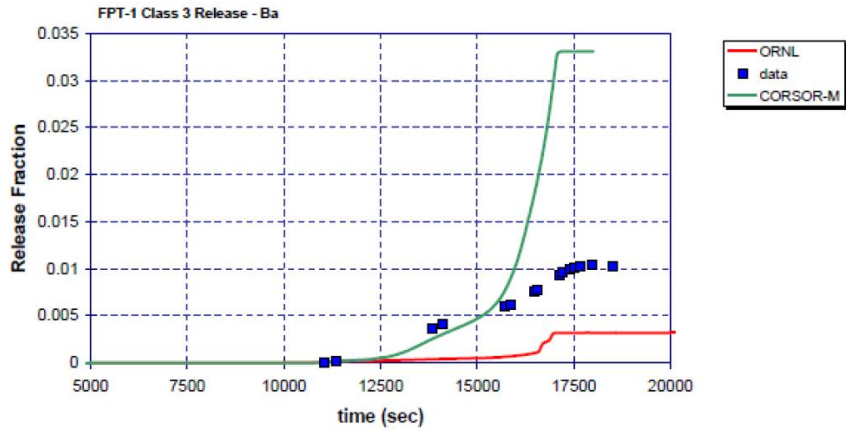

VERCORS Test Facility

G. Ducros et al. / Nuclear Engineering and Design 208 (2001) 191–203

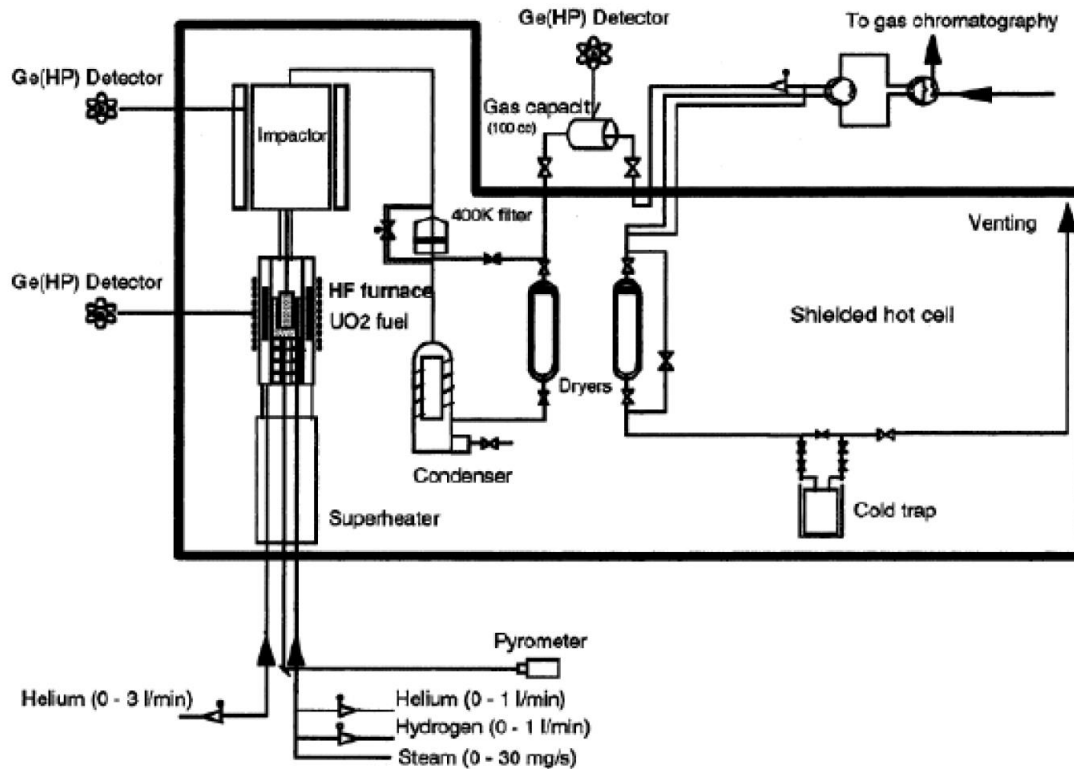

VERCORS-2 Cs

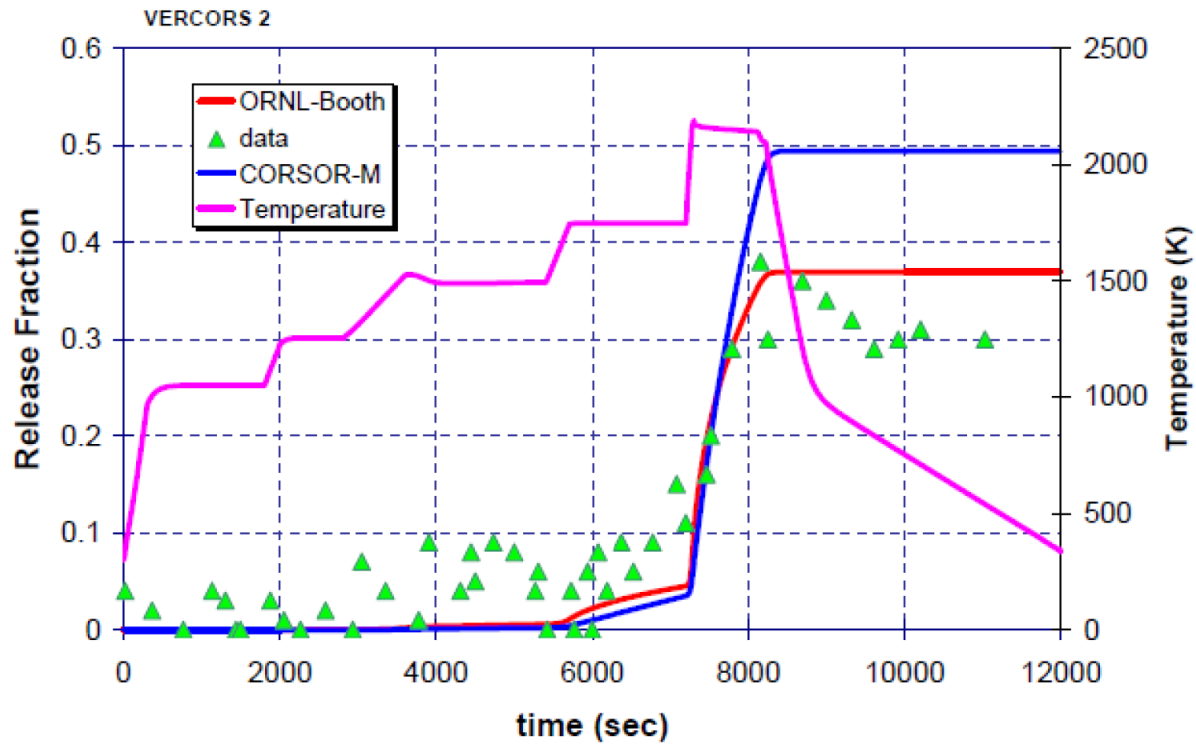

VERCORS-4 Cs

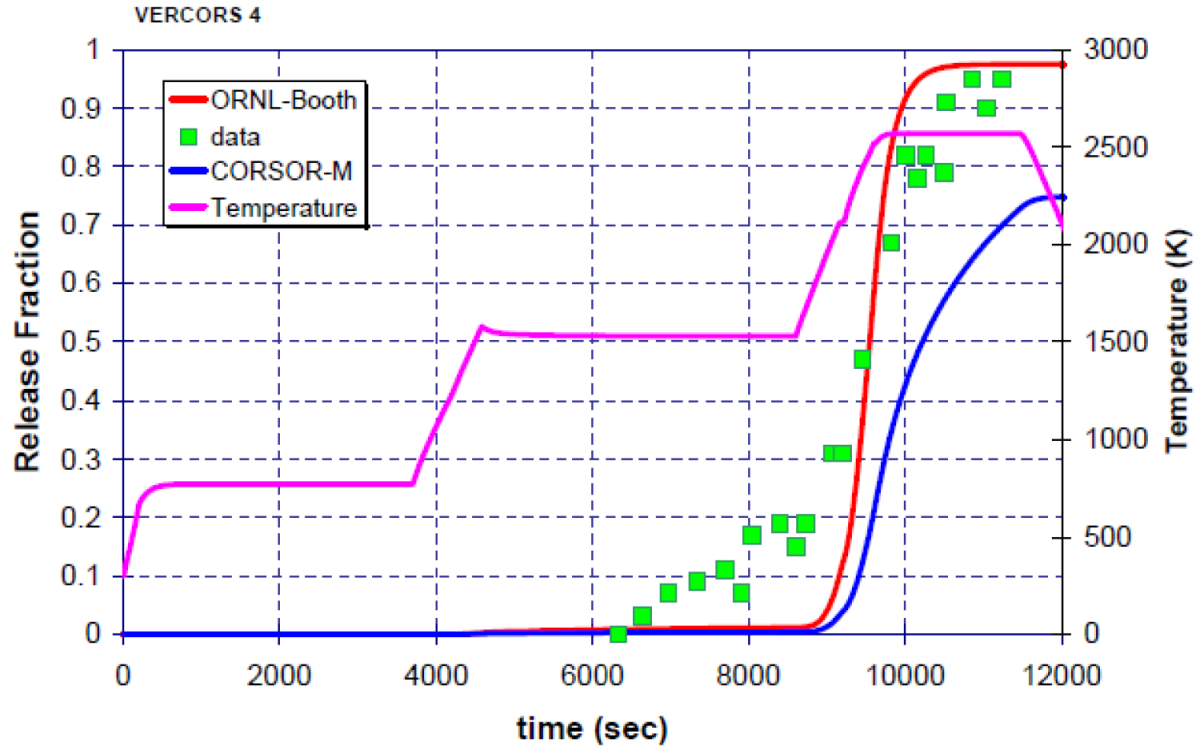

VERCORS-4 Other Classes



Te

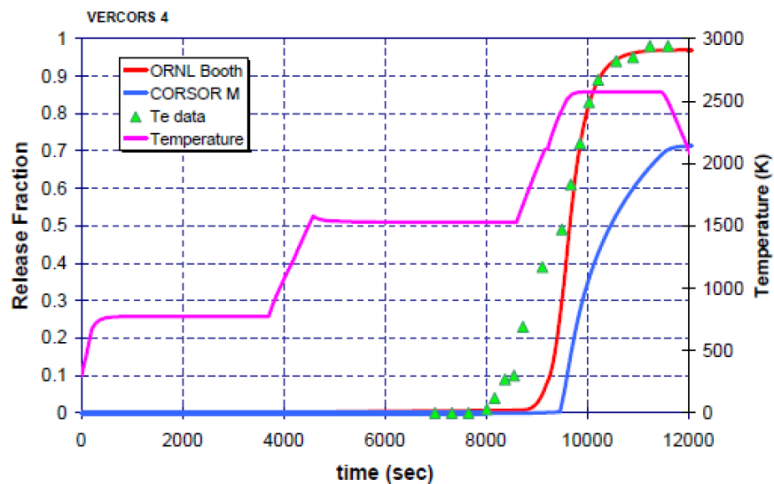

Ba

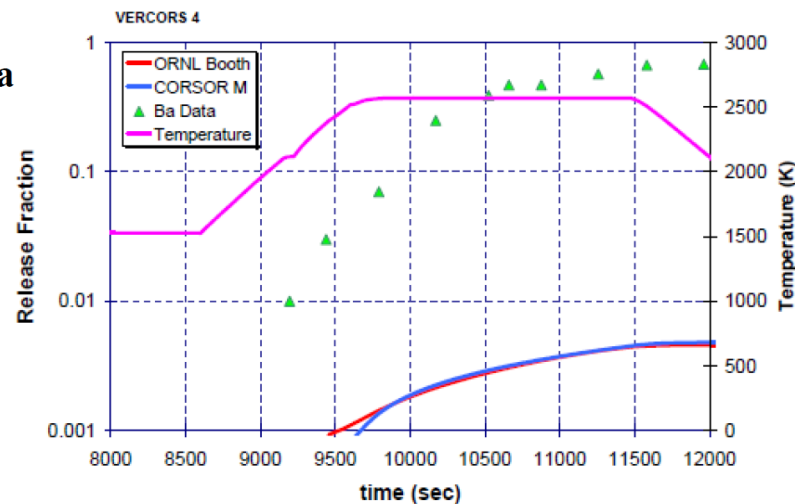

Mo

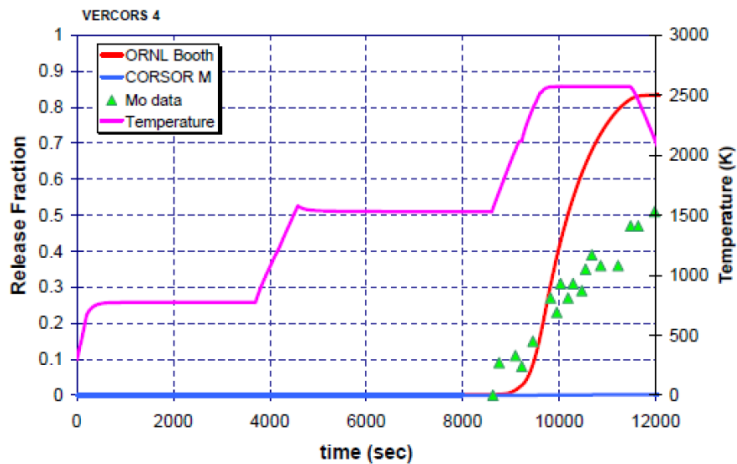

I

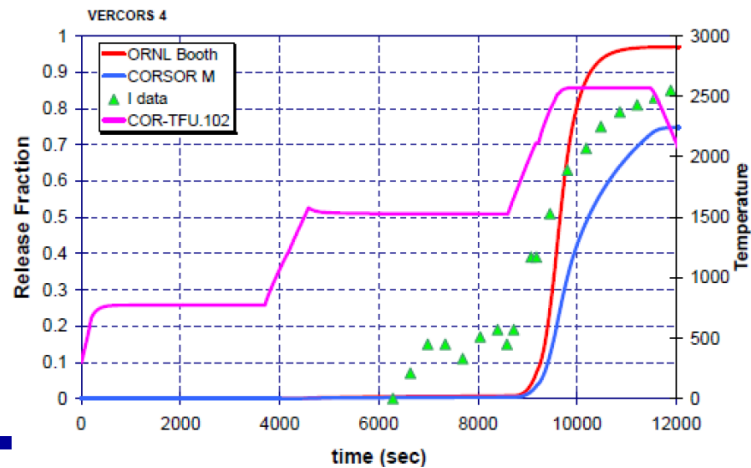

Generalized Release Model



An alternative offering flexibility and customizability

- A “burst” component, cumulative burst release fraction:

$$FB_{j,i} = a_burst_j (c_0 + c_1 * T_i + c_2 * T_i^2 + c_3 * T_i^3) \quad \text{Where}$$

T_i is the fuel temperature that existed during the time interval Dt_i
 c_0, c_1, c_2, c_3 are constant coefficients provided in user input
 a_j is a constant class dependent coefficient provided in user input.

- A “diffusion” component, cumulative diffusive release fraction:

$$FD_{j,i} = b_diff_j (FD_{j,i-1} + (1 - FB_{j,i-1} - FD_{j,i-1}) \cdot [1 - e^{-kd_{j,i} \Delta t_i}])$$

Where

$FD_{j,i}$ is the cumulative fraction of diffusive fission product released up to time t_i

B_diff_j is a constant class dependent coefficient provided in user input

$FD_{j,i-1}$ is the cumulative fraction of diffusive fission product released up to time t_{i-1}

FB_i is the cumulative fraction of burst fission product released up to time t_i

$[1 - e^{-kd_{j,i} \Delta t_i}]$ is the fractional release due to diffusion during the time interval Dt_i

$kd_{j,i}$ is the release rate coefficient for fission product class j calculated using the temperature, T_i , that existed during the time interval Dt_i

$$kd_{j,i} = A_j e^{-B_j / (RT_i)}$$

Where A_j and B_j are class dependent coefficients provided in user input.

Generalized Release Model



Total cumulative fission product release fraction at t_i for j is:

$$F_{j,i} = d_{total_j} \cdot (FB_{j,i} + FD_{j,i})$$

 **User supplied class-dependent multiplier**

Cumulative release cannot exceed amount available

$$FB_{j,i} = FB_{j,i-1} \text{ and } FD_{j,i} = FD_{j,i-1} \text{ when } FD_{j,i} \geq 1.0$$

Time derivative of cumulative burst release ≥ 0 , and if temperature decreases, cumulative burst remains constant

$$FB_{j,i} = FB_{j,i-1} \text{ when } T_{i-} \geq T_{B-max} \text{ or } T_{melting}$$

Cumulative burst release reaches maximum when temperature reaches the lower of T_{B-max} or $T_{melting}$

$$FB_{j,i} = FB_{j,i} \text{ when } T_i \geq T_{B-max} \text{ or } T_{melting}$$

TRISO Fuel Release



HTGR (PBR/FHR and PMR) fuel element release entails phenomena not occurring in LWRs

- Failure and release spread out over time
 - Low level operational release (circulating activity)
 - Longer accident release time scale
- Graphite dust present in primary

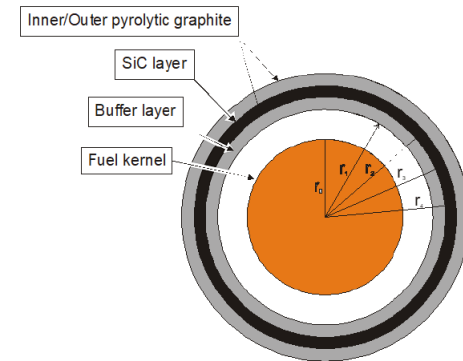

TRISO diffusional fission product release model considers

- Diffusion from kernel through to fuel element matrix and out
- Fission product recoil
- Tramp Uranium (contamination)
- TRISO particle failure (burst and subsequent diffusion)
- Time and temperature history of diffusion
- Graphite dust generation and transport (e.g. as aerosol)

TRISO Fuel Release



Intact TRISO Particles

- 1-D FV diffusion solver, multiple zones (materials)
- $D(T)$ in Arrhenius form

$$\frac{\partial C}{\partial t} = \frac{1}{r^n} \frac{\partial}{\partial r} \left(r^n D \frac{\partial C}{\partial r} \right) - \lambda C + \beta \quad D(T) = D_0 e^{-\frac{Q}{RT}}$$

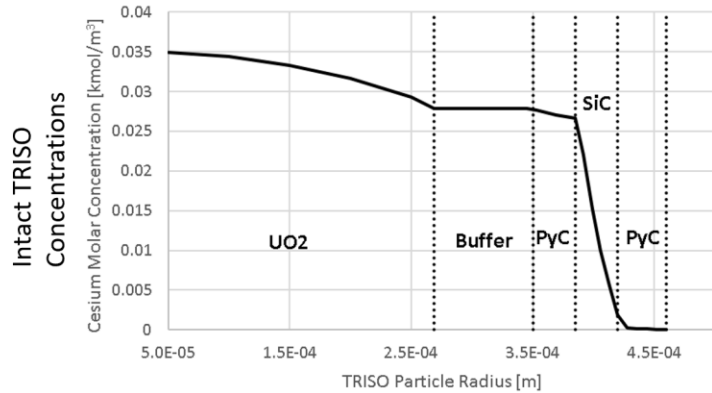
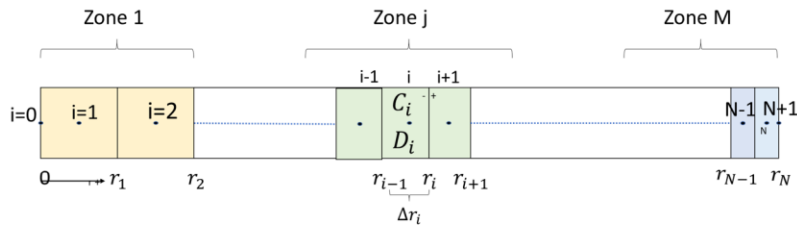

Diffusivity Data Availability

Radionuclide	UO ₂	UCO	PyC	Porous Carbon	SiC	Matrix Graphite	TRISO Overall	
Ag	Some	Not Investigated	Some	Not found	Extensive	Some	Extensive	
Cs	Some		Some		Extensive	Some	Some	
I	Some		Some		Some	Not found	Not found	Not found
Kr	Some		Some		Not found	Some	Some	
Sr	Some		Some		Extensive	Some	Some	
Xe	Some		Some		Some	Some	Not found	

Data used in the demo calculation [IAEA TECDOC-0978]

Layer	FP Species							
	Kr		Cs		Sr		Ag	
	D (m ² /s)	Q (J/mole)	D (m ² /s)	Q (J/mole)	D (m ² /s)	Q (J/mole)	D (m ² /s)	Q (J/mole)
Kernel (normal)	1.3E-12	126000.0	5.6-8	209000.0	2.2E-3	488000.0	6.75E-9	165000.0
Buffer	1.0E-8	0.0	1.0E-8	0.0	1.0E-8	0.0	1.0E-8	0.0
PyC	2.9E-8	291000.0	6.3E-8	222000.0	2.3E-6	197000.0	5.3E-9	154000.0
SiC	3.7E+1	657000.0	7.2E-14	125000.0	1.25E-9	205000.0	3.6E-9	215000.0
Matrix Carbon	6.0E-6	0.0	3.6E-4	189000.0	1.0E-2	303000.0	1.6E00	258000.0
Str. Carbon	6.0E-6	0.0	1.7E-6	149000.0	1.7E-2	268000.0	1.6E00	258000.0

Iodine assumed to behave like Kr

CORSOR-Booth LWR scaling used to estimate other radionuclides

TRISO Fuel Release

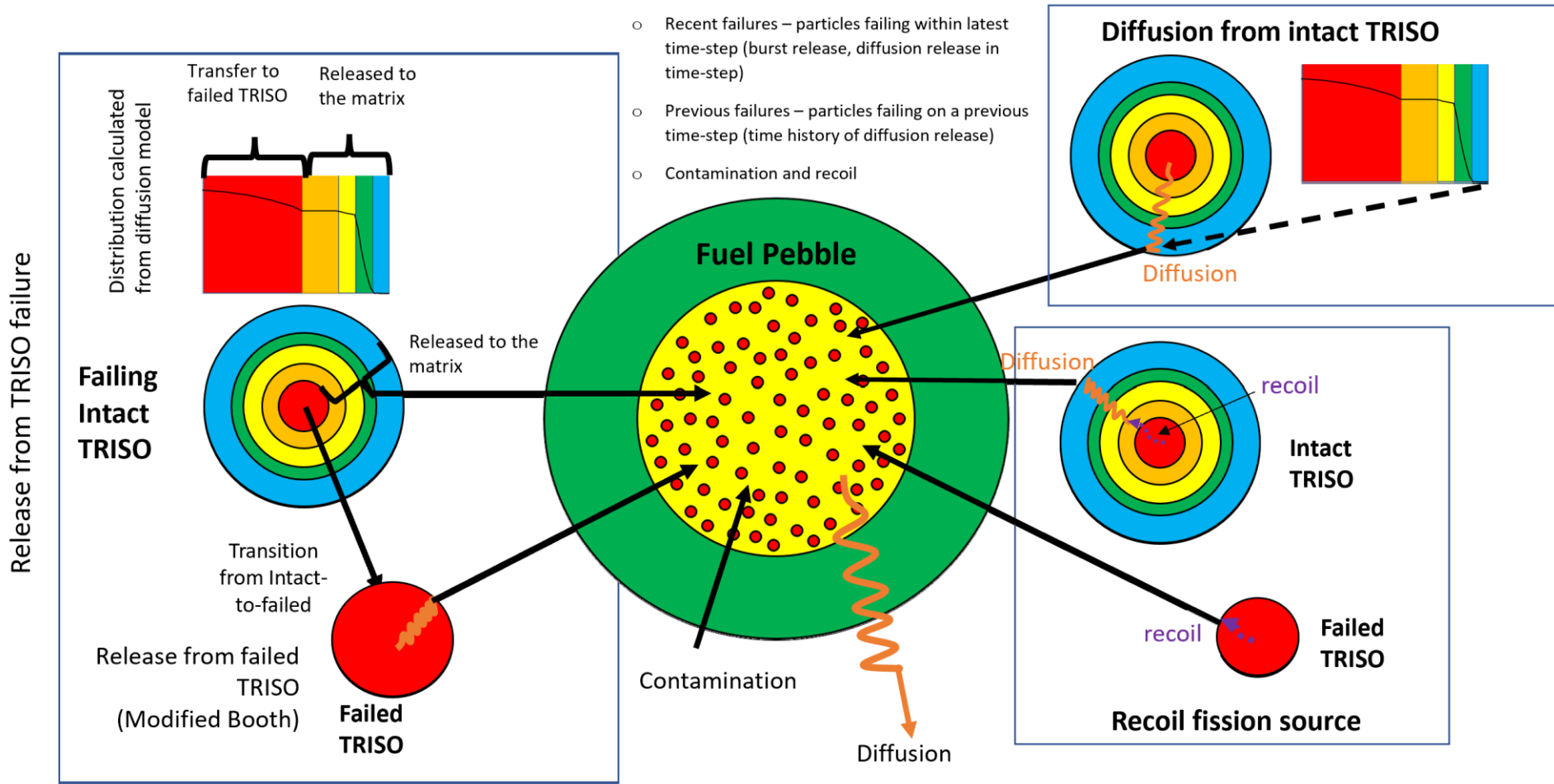

Metal Fuel Release

Begin: as-fabricated pin is clean/unburned/unswollen

Pre-transient: burned pin transforms as-fabricated pin

- Bond sodium contents and thickness/volume
- Pin gas plenum contents and volume
- Fuel porosity distribution, contents, volume
- One-time computation of redistributions

Transient: compute in-pin dynamics

- Fuel can melt, create cavities – possibly contiguous
- Fission gas (closed to open, solid fuel to molten)
- Fuel can release fission products to gap, plenum

Accident: pin failure then severe core degradation

- CL gap release, CL/CN candling, eventual collapse
- FU/CL collapse, PD/MP formation, subsequent relocation

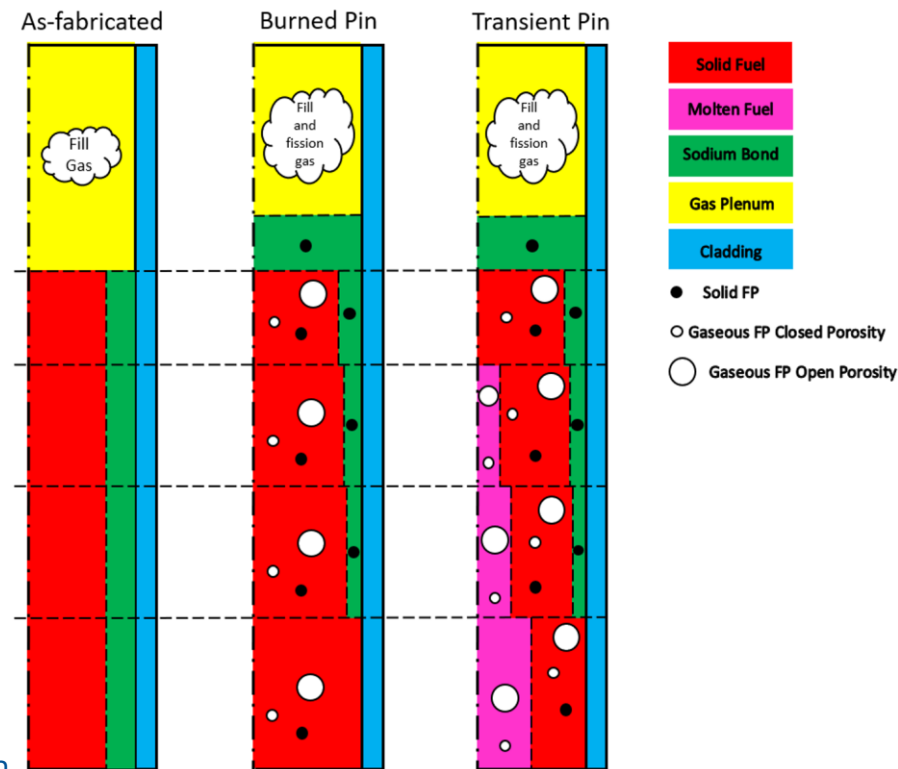

Ag-In-Cd Control Rod Release



FPT-1 post-test analysis demonstrated the importance of predicting structural aerosol releases from CR materials

MELCOR has 1 material (e.g. primary of NS component used for control rods) representing all three of Ag-In-Cd

- Material vapor pressure taken as the lowest of Ag, In, or Cd
- Material composition does not change when in reality Cd, In, and Ag would vaporize, respectively, and composition would change
- Vaporization model therefore entails some simplification

Mass diffusion in bulk gas controls vaporization

- No NS component cooling by vaporization
- No vapor condensation allowed

$$\dot{m}_v = h_m A_c M_{Ag} \left(\frac{P_v(T_c)}{RT_c} - \frac{P_{Ag}(T_b)}{RT_b} \right)$$

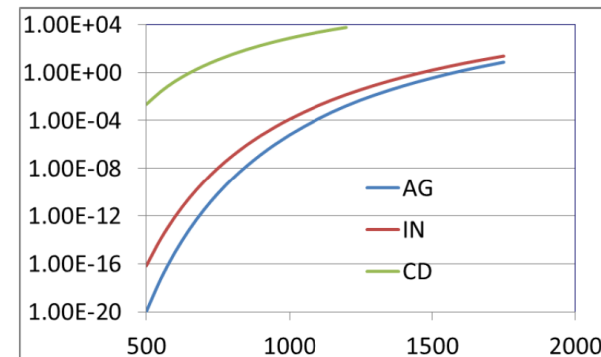

Ag-In-Cd Control Rod Release



COR_CR record to enable

COR_CR ACTC

User must specify 3 new RN classes (AG-CR, IN-CR, CD-CR)

- DCH_CL and DCH_EL
- Vapor pressure (SC7110)
- Diffusion (SC7111)
- Mol. Weights (SC7120)

(1) IAICON

Turns on the silver release model

(a) 0 or NACT

Model is not active. No additional fields are required.

(b) 1 or ACTC

Model is active, vaporization is allowed from candling material only

(c) 2 or ACTDC

Model is active, vaporization is allowed from both candling material and conglomerate

(type = integer / character*5, default = 0, units = none)

The following fields are required if and only if IAICON = ACTC or 1, ACTDC or 2. If they are not set, then the default values will be used:

(2) ARATIO

The area ratio of break area to control rod internal cross-sectional area. This cannot be greater than 1.

(type = real, default = 0.1, units = none)

(3) AKFRCT

The flow loss coefficient used in the release velocity calculation. If input, this will override the value calculated according to the formula given in the reference manual.

(type = real, default = $0.32 \cdot (1.0 - \text{ARATIO})$, units = none)

Summary



Reviewed CORSOR, CORSOR-M, CORSOR-Booth, and modified CORSOR-Booth models

Reviewed the generalized release model

Reviewed aspects of certain non-LWR specific release models

- TRISO fuel and fuel elements (diffusional fission product release)
- Metallic fuel as in SFRs

Reviewed structural release model for Ag-In-Cd in CRs

NOT mentioned...fission product release in CAV (VANESA)
