

The mu3e experiment

Frederik Wauters
Johannes Gutenberg University Mainz

CLFV & $\mu^+ \rightarrow e^+ e^+ e^-$

Charged Lepton Flavour Violation and the Standard Model

- ❑ Neutrino masses/oscillations have established LFV in SM+
 - ❑ **Charged** LFV has not yet been observed: beyond SM. But CLF is not a fundamental SM symmetry
 - ❑ Leptons are a clean probe, i.e. free of SM background
 - ❑ Muons hit the sweet spot between sensitivity and availability.
- Note there are also $\tau \rightarrow e\gamma$, $\tau \rightarrow \mu\gamma$, $\tau \rightarrow \mu\mu\mu$ searches at e.g. Belle II

- ❑ Three golden muon channels:

❑ $\mu^+ \rightarrow e^+ \gamma$	MEG $< 4 \cdot 10^{-13}$	⇒	MEGII $< 5 \cdot 10^{-14}$
❑ $\mu^+ \rightarrow e^+ e^+ e^-$	SINDRUM $< 1 \cdot 10^{-12}$	⇒	Mu3e $< 2 \cdot 10^{-15}$
❑ $\mu^- N \rightarrow e^- N$	SUNDRUMII $< 7 \cdot 10^{-13}$	⇒	Mu2e, COMET, DeeMee $< 10^{-16}$

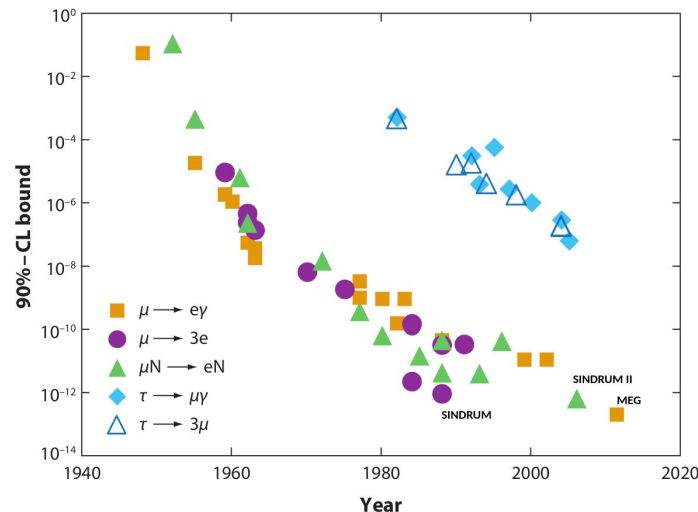
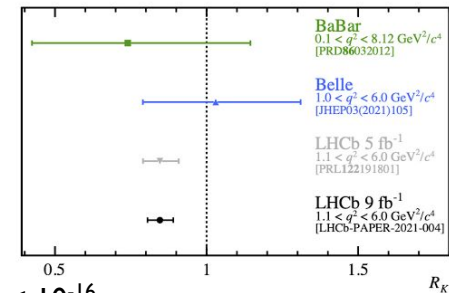
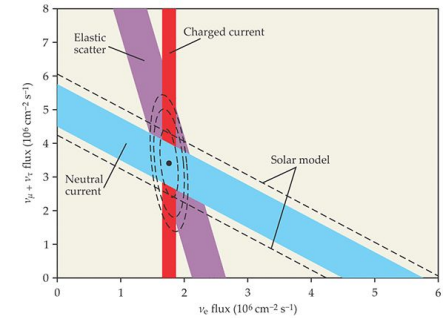

CLFV & $\mu^+ \rightarrow e^+ e^+ e^-$

Charged Lepton Flavour Violation and the Standard Model

- ❑ Neutrino masses/oscillations have established LFV in SM+
 - ❑ **Charged** LFV has not yet been observed: beyond SM. But CLF is not a fundamental SM symmetry
 - ❑ Leptons are a clean probe, i.e. free of SM background
 - ❑ Muons hit the sweet spot between sensitivity and availability.
- Note there are also $\tau \rightarrow e\gamma$, $\tau \rightarrow \mu\gamma$, $\tau \rightarrow \mu\mu\mu$ searches at e.g. Belle II
- ❑ Three golden muon channels:

- ❑ $\mu^+ \rightarrow e^+ \gamma$ MEG $< 4 \cdot 10^{-13}$ \Rightarrow MEGII $< 5 \cdot 10^{-14}$
- ❑ $\mu^+ \rightarrow e^+ e^+ e^-$ SINDRUM $< 1 \cdot 10^{-12}$ \Rightarrow Mu3e $< 2 \cdot 10^{-15}$
- ❑ $\mu^- N \rightarrow e^- N$ SINDRUMII $< 7 \cdot 10^{-13}$ \Rightarrow Mu2e, COMET, DeeMee $< 10^{-16}$

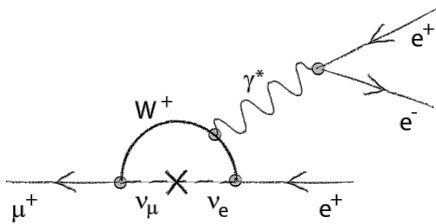
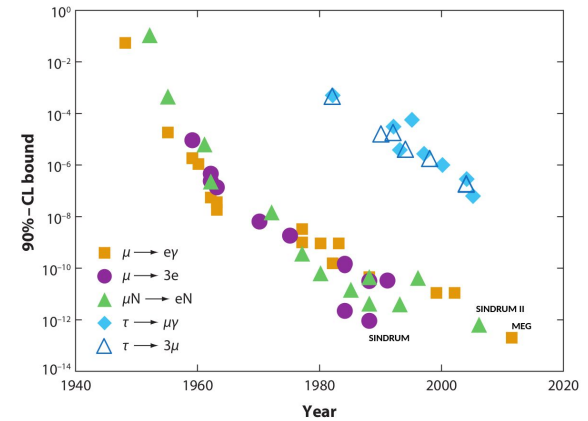

$BR(SM) < 10^{-54}$

Zoo of possible tree and loop level BSM contributions

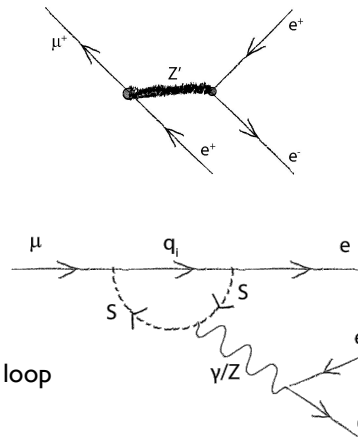

Access to >1000 TeV

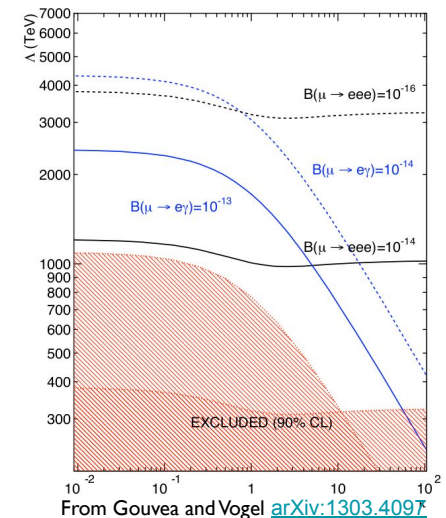

Kuno et al. [arXiv:hep-ph/990926](https://arxiv.org/abs/1909.0926)
Crevellin et al. [arXiv:1702.03020](https://arxiv.org/abs/1702.03020)

$\mu^+ \rightarrow e^+e^+e^-$ & the Mu3e experiment

Detecting $\mu^+ \rightarrow e^+e^+e^-$ for muon decay at rest

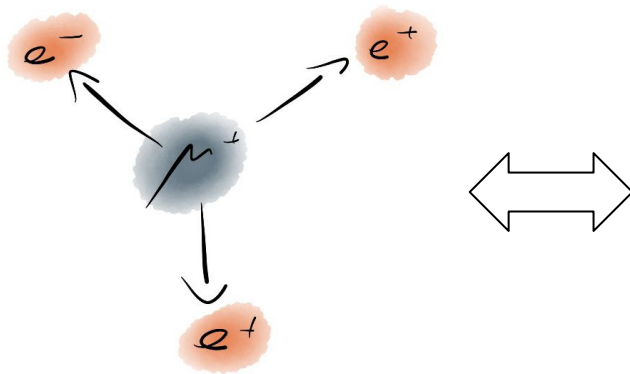

- Common vertex
- Time coincident
- $\sum E = m_\mu$
- $\sum \mathbf{p} = 0$

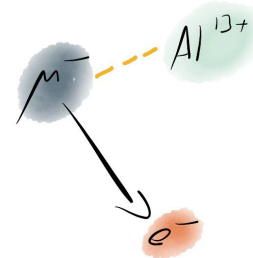

- Mono-energetic e^-
- No coincidence

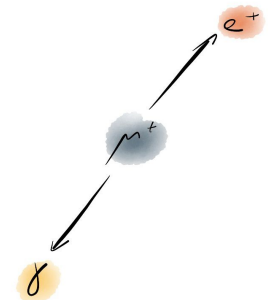

- Mono-energetic e^+ and γ
- back-back coincidence

$\mu^+ \rightarrow e^+e^+e^-$ & the Mu3e experiment

Detecting $\mu^+ \rightarrow e^+e^+e^-$ for muon decay at rest

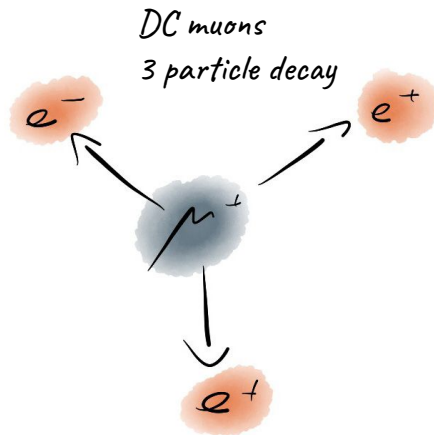

- Common vertex
- Time coincident
- $\sum E = m_\mu$
- $\sum \mathbf{p} = 0$

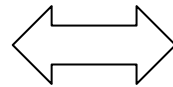

*Pulsed muons
Only one particle*

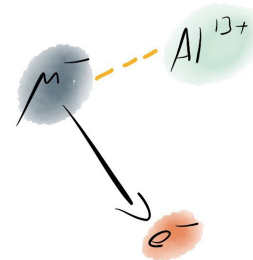

- Mono-energetic e^-
- No coincidence

*DC muons
Clear signal*

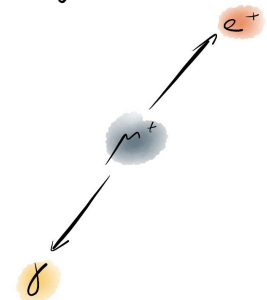

- Mono-energetic e^+ and γ
- back-back coincidence

$\mu^+ \rightarrow e^+ e^+ e^-$ & the Mu3e experiment

Detecting $\mu^+ \rightarrow e^+ e^+ e^-$ for muon decay at rest: Backgrounds

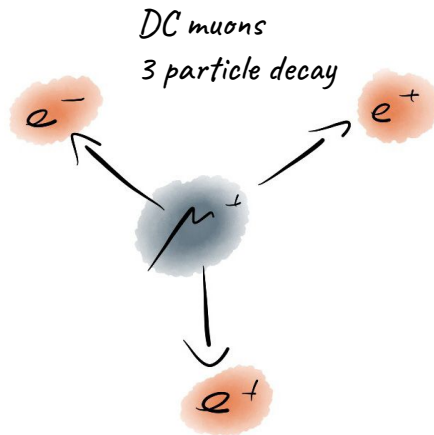

- Common vertex
- Time coincident
- $\sum E = m_\mu$
- $\sum \mathbf{p} = 0$

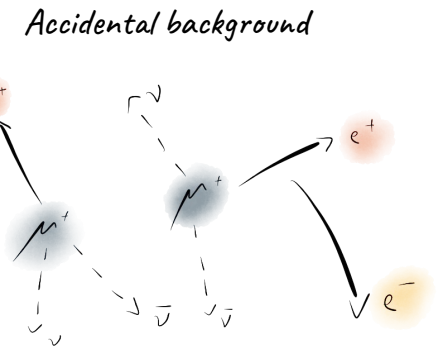
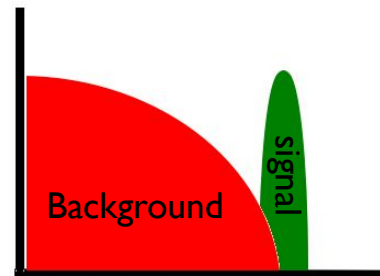
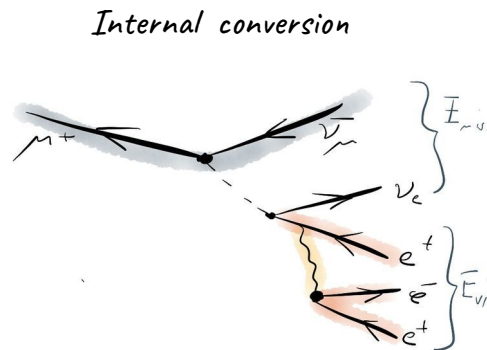

Michel decay positrons plus electron from:

- Bhabha scattering
- Photon conversion
- Mis reconstruction

Our detector needs:

- Excellent momentum resolution
- Good time and vertex resolution
- High rate capability

Mu3e conceptual design



- ❑ 2.3 mA 600 MeV proton beam from HIPA at PSI
- ❑ $10^8 \mu^+/s$ (DC) at the $\pi E5$ area
- ❑ Stopped on a thin Mylar target

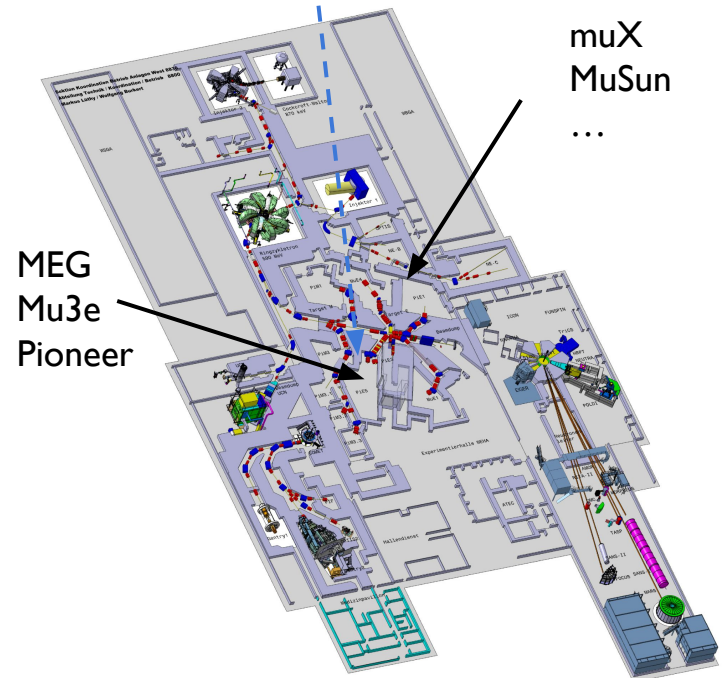

Mu3e conceptual design

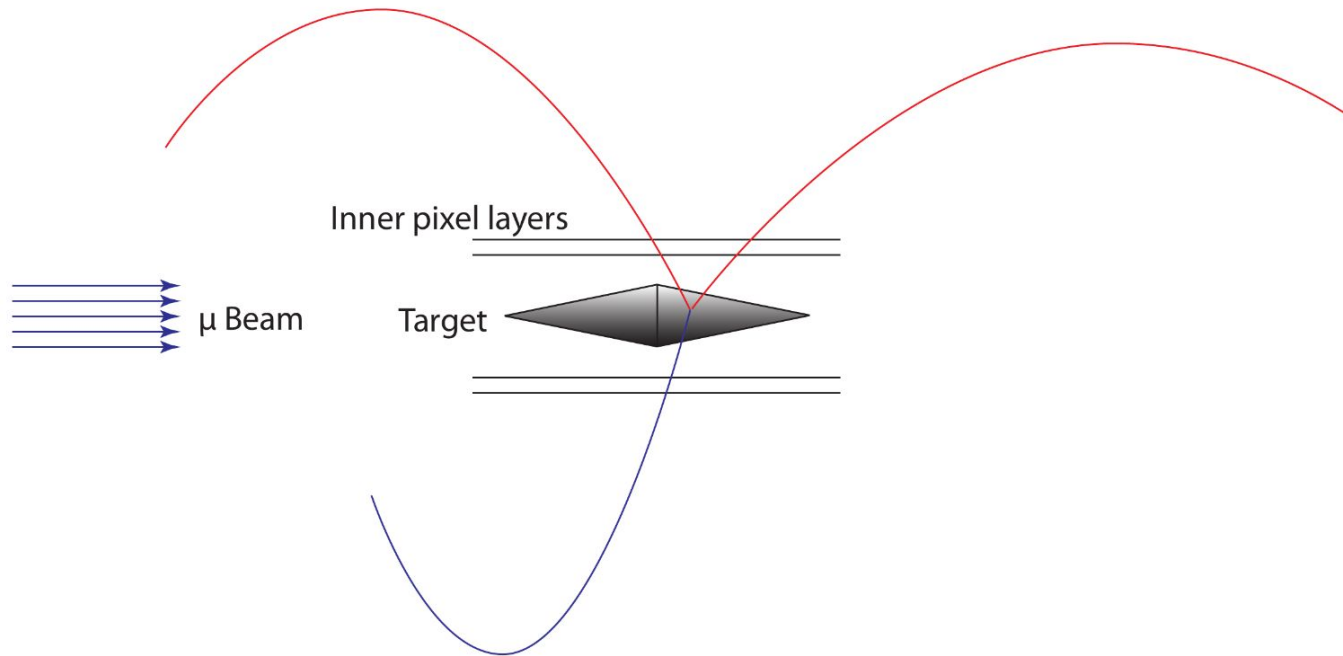

- ❑ 2 layer vertex detector
- ❑ 1T uniform magnetic field
- ❑ 2 e^+ and e^- helical tracks

Mu3e conceptual design

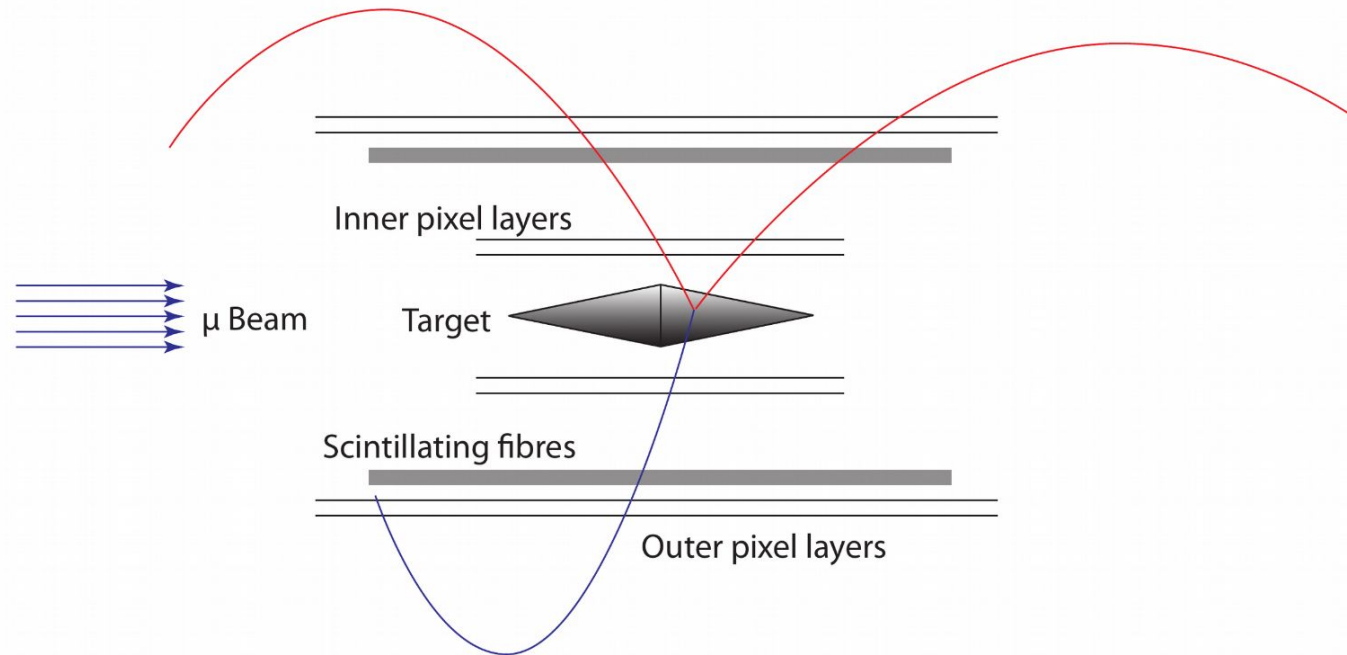

- ❑ 2 outer pixel layers \rightarrow 4 hits to *start* the track
- ❑ Fibre detector for the track direction, i.e. differentiate e^+ from e^-

Mu3e conceptual design

- ❑ Recurl tracking station to accept half turn track for optimal momentum resolution
- ❑ Tile detector for optimal timing (< 100 ps)

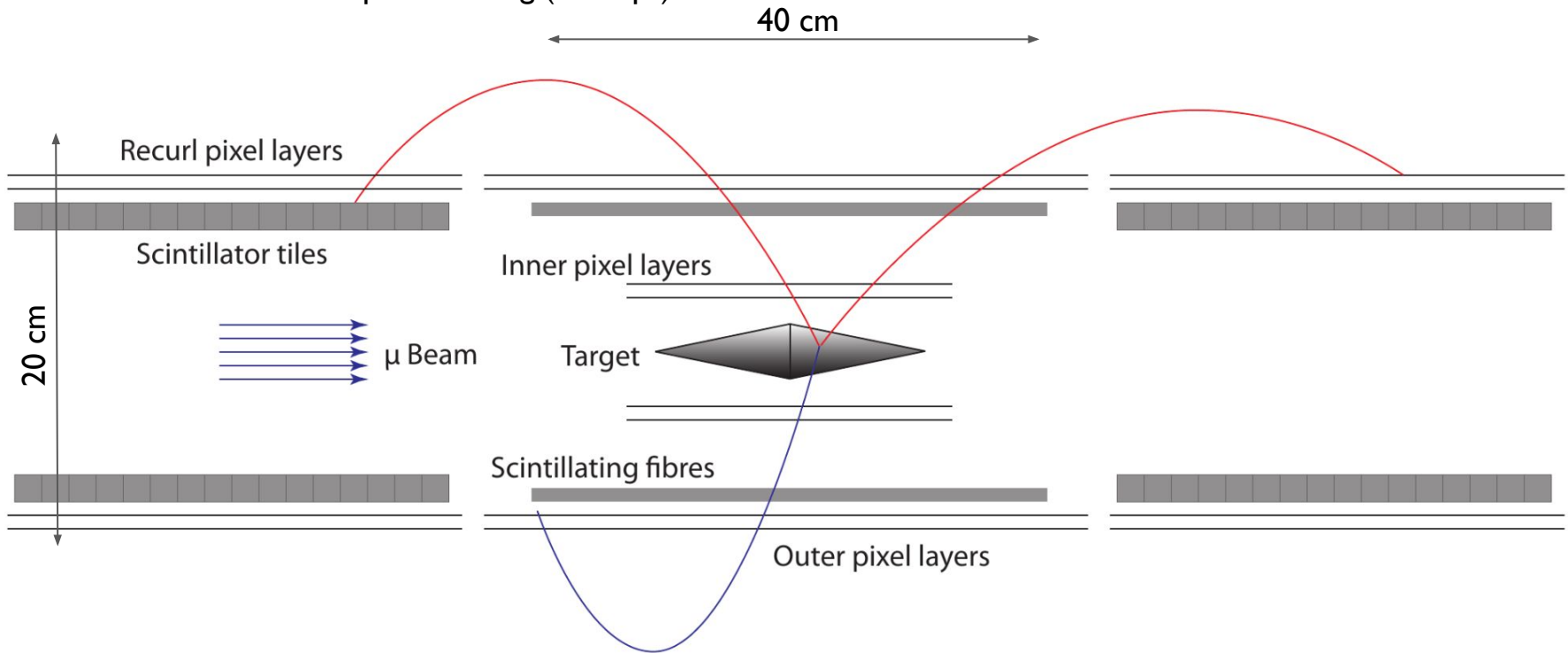

Mu3e conceptual design

- ❑ Recurl tracking station to accept half turn track for optimal momentum resolution
- ❑ Tile detector for optimal timing (< 100 ps)

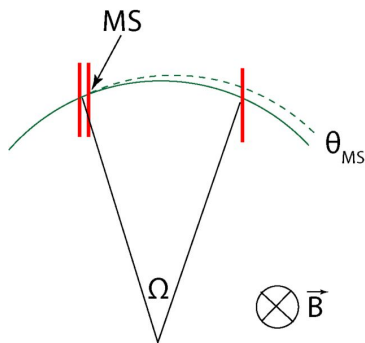
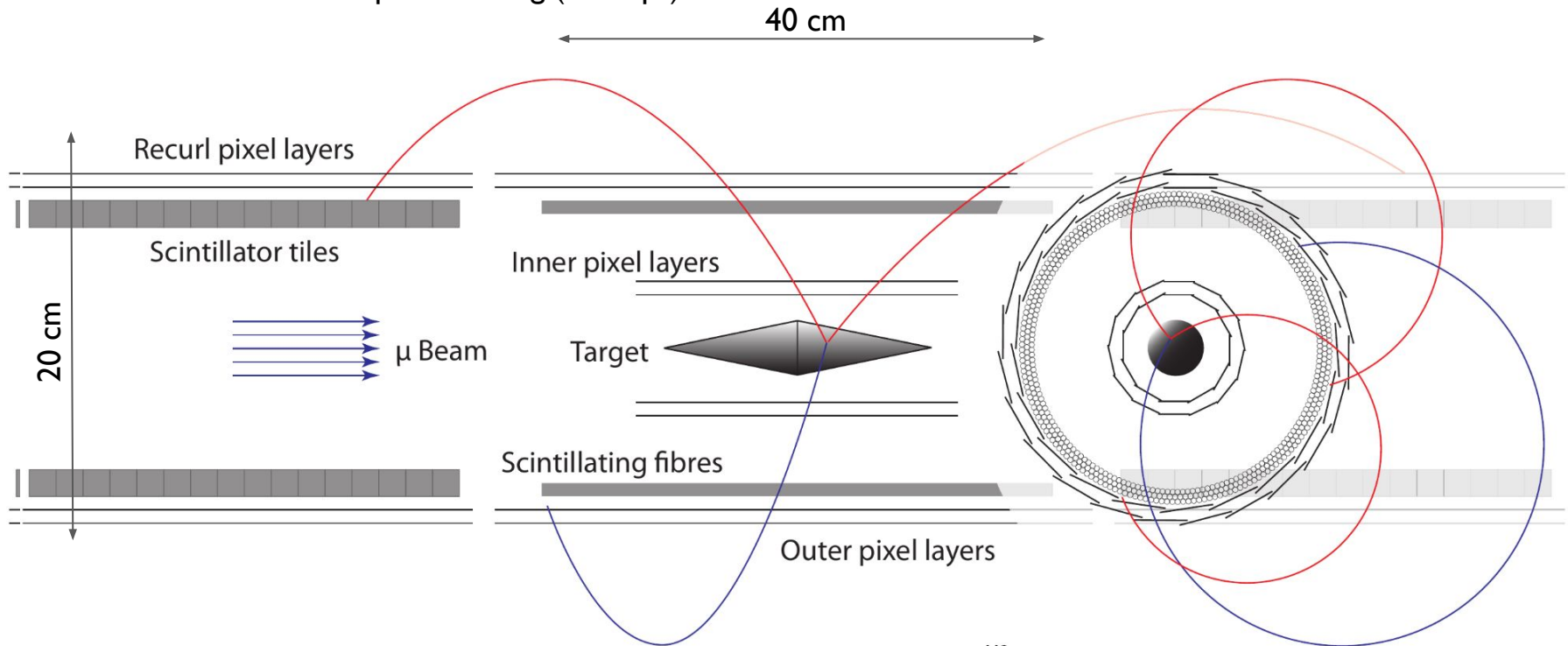

In the MS dominated regime, a half-turn spectrometer provides optimal momentum resolution

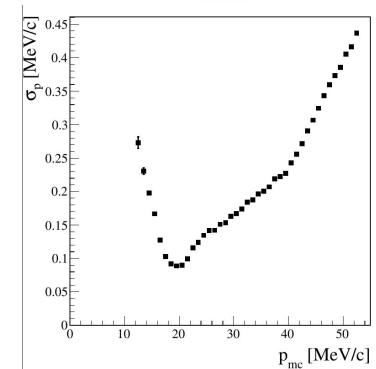
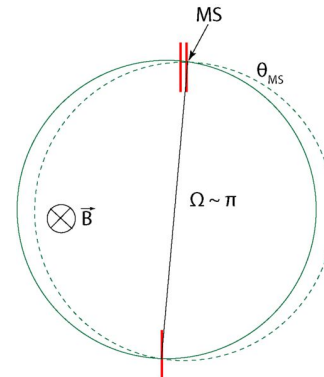

Mu3e Detectors

Lightweight pixel tracker build from High Voltage Monolithic Active Pixel Sensors (HV-MAPS) called **MuPix**

A decade of detector development and test beams

- ❑ Commercial CMOS process
- ❑ Fast Charge collection
- ❑ Integrated analogues and digital RO
- ❑ Can be thinned to 50 μm

Concept

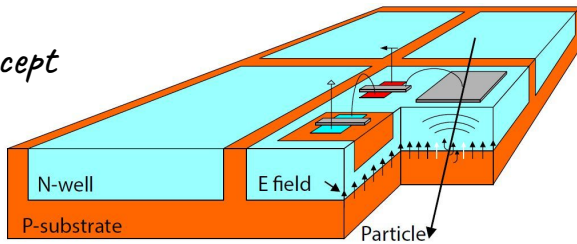

Prototyping MuPix ... \rightarrow ?

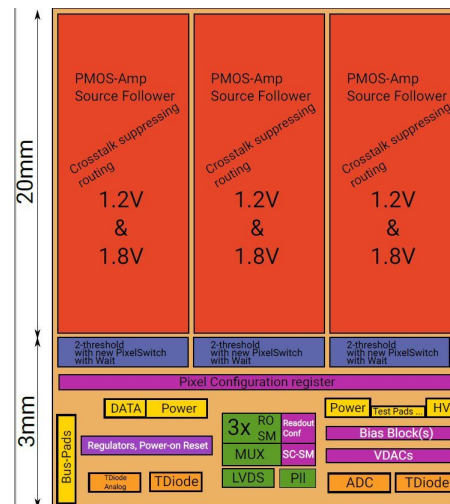
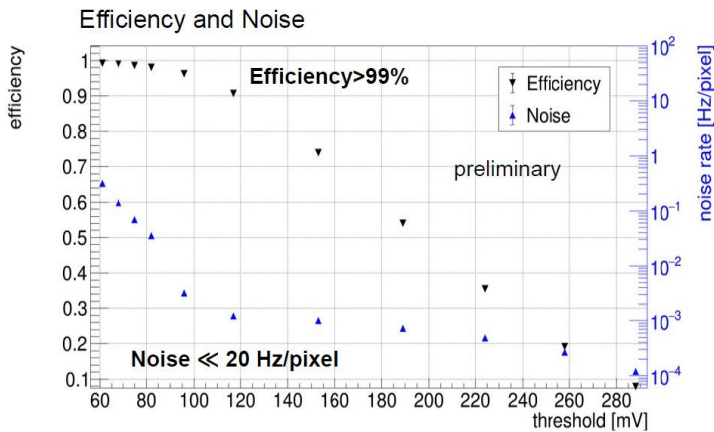
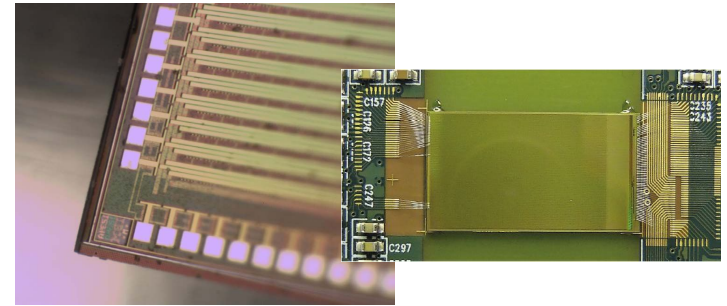

Full Chip

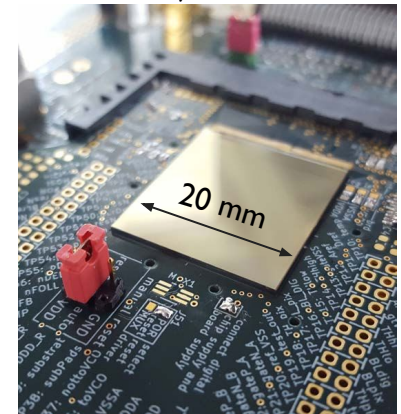

Mu3e Detectors

Lightweight pixel tracker build from High Voltage Monolithic Active Pixel Sensors (HV-MAPS) called **MuPix**

Ladders from 50 μm of Si, 25 μm of Alu/Kapton flex, and 25 μm of kapton support.
 → ca. 0.1% of a radiation length!

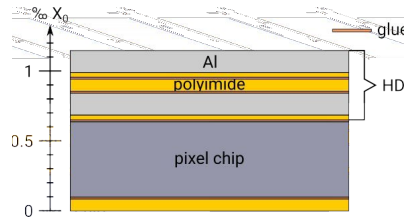
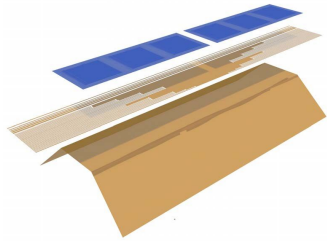

The is a compact but large pixel tracker!

- ❑ 2 vertex layers
- ❑ 3 * 2 outer layers
- ❑ 174 ladders
- ❑ 2844 2x2 cm² MuPiX chips
- ❑ 3060 1.25 Gb/s data links
- ❑ 50 g/s, 10m/s 5kW gaseous helium cooling

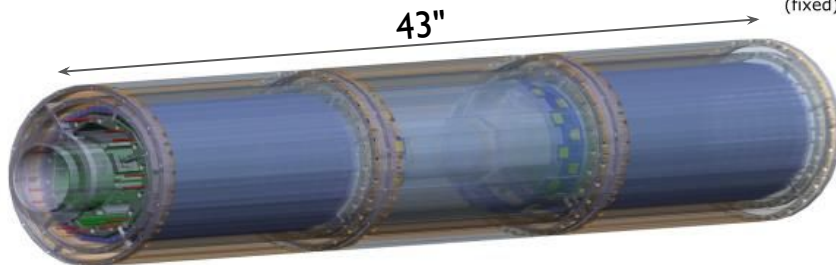
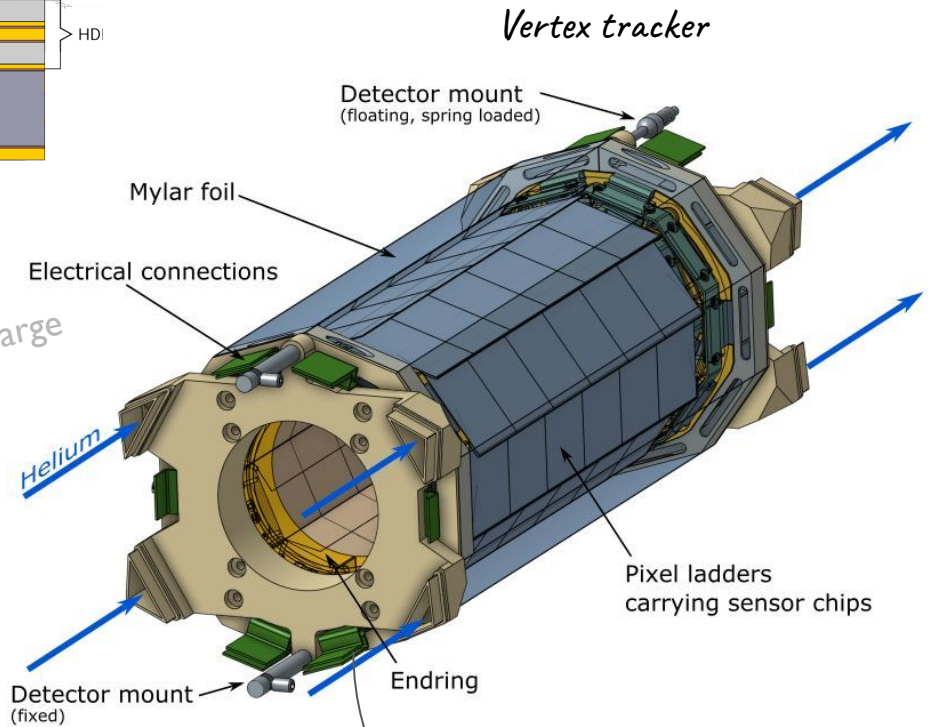

+ HV & power

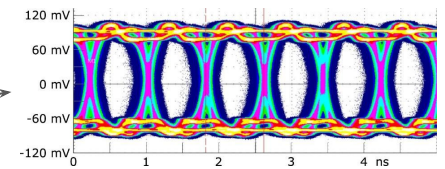

Mu3e Detectors

Timing detectors

- ❑ 3 layer / 12 ribbons scintillating fibre detector surrounding the vertex detector
- ❑ Highly granular tile detector under the recoil stations

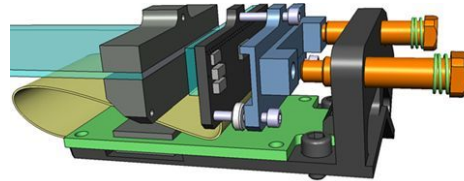
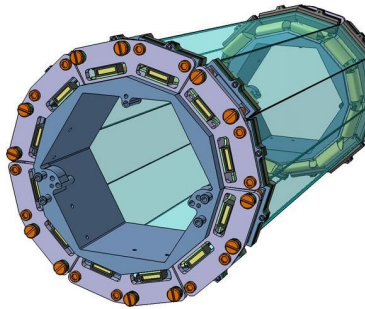

All fibre and pixel modules are spring loaded to compensate for thermal expansions.

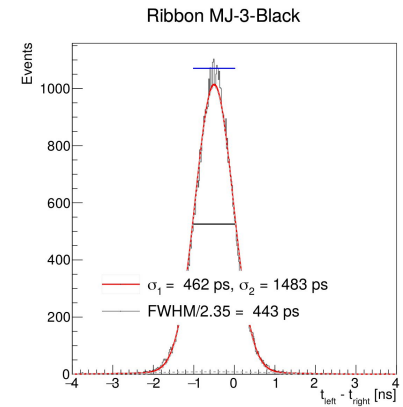
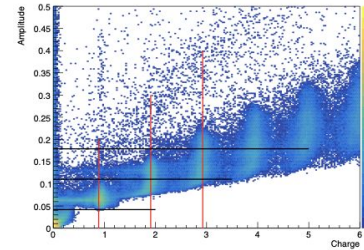

6272 tiles with plenty of light give us ca. 70 ps time resolution

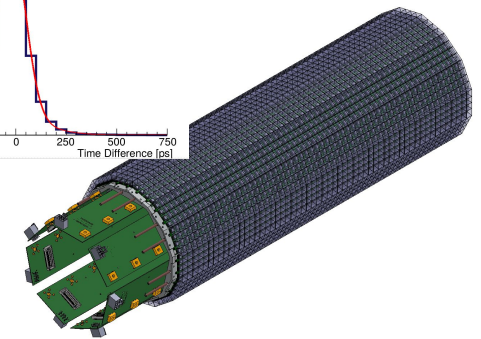
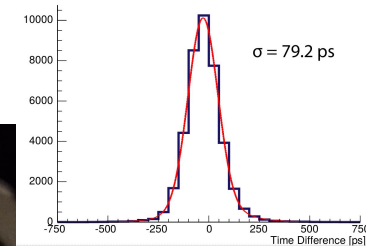

Mu3e Detectors

Timing detectors

- ❑ 3 layer / 12 ribbons scintillating fibre detector surrounding the vertex detector
- ❑ Highly granular tile detector under the recur stations

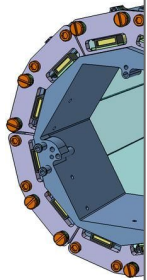

6272 tiles

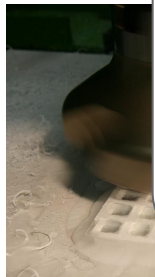

MuTrig: A custom 32 (SiPM) channel RO chip with a single 1.25 Gb/s data link

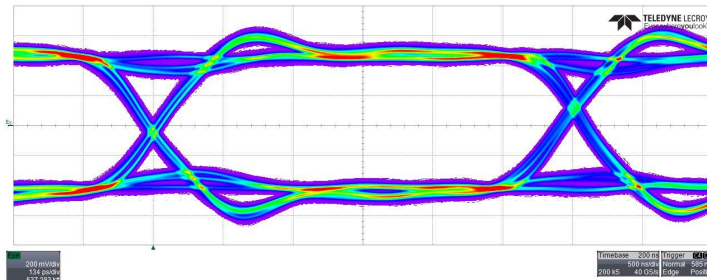
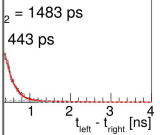
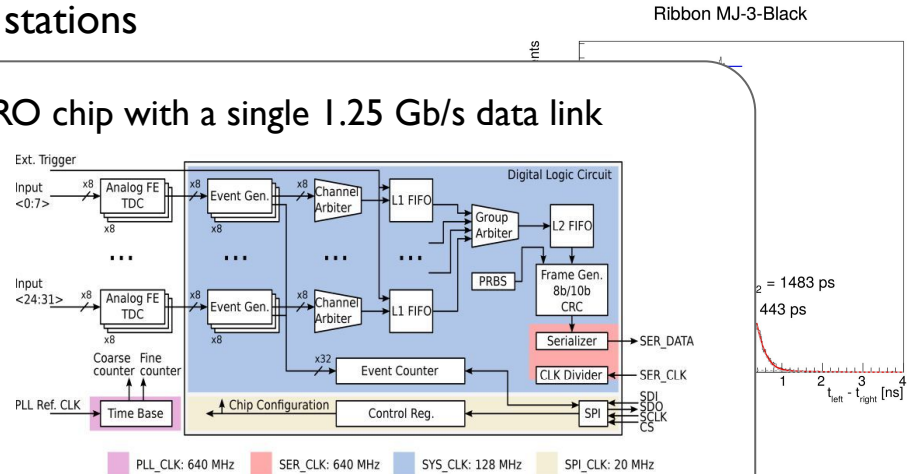
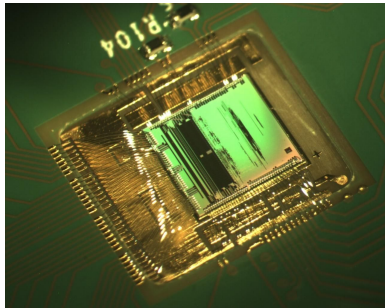
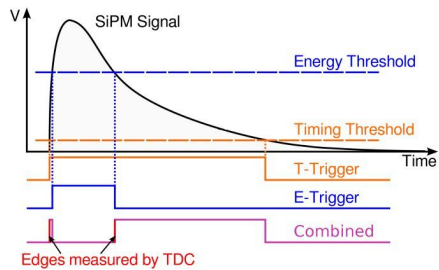

Mu3e DAQ

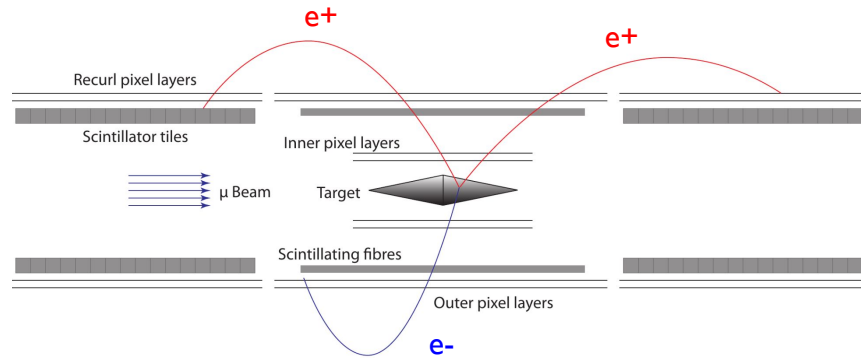

Reminder: the Mu3e event topology does not allow for a RO trigger, every Michel electron could also be part of a $\mu^+ \rightarrow e^+ e^+ e^-$ event. Only the kinematics of the combined final state positrons/electron gives us an event selection criteria.

Mu3e = lightweight and fast Michel electron tracker + high throughput online reconstruction & selection DAQ system

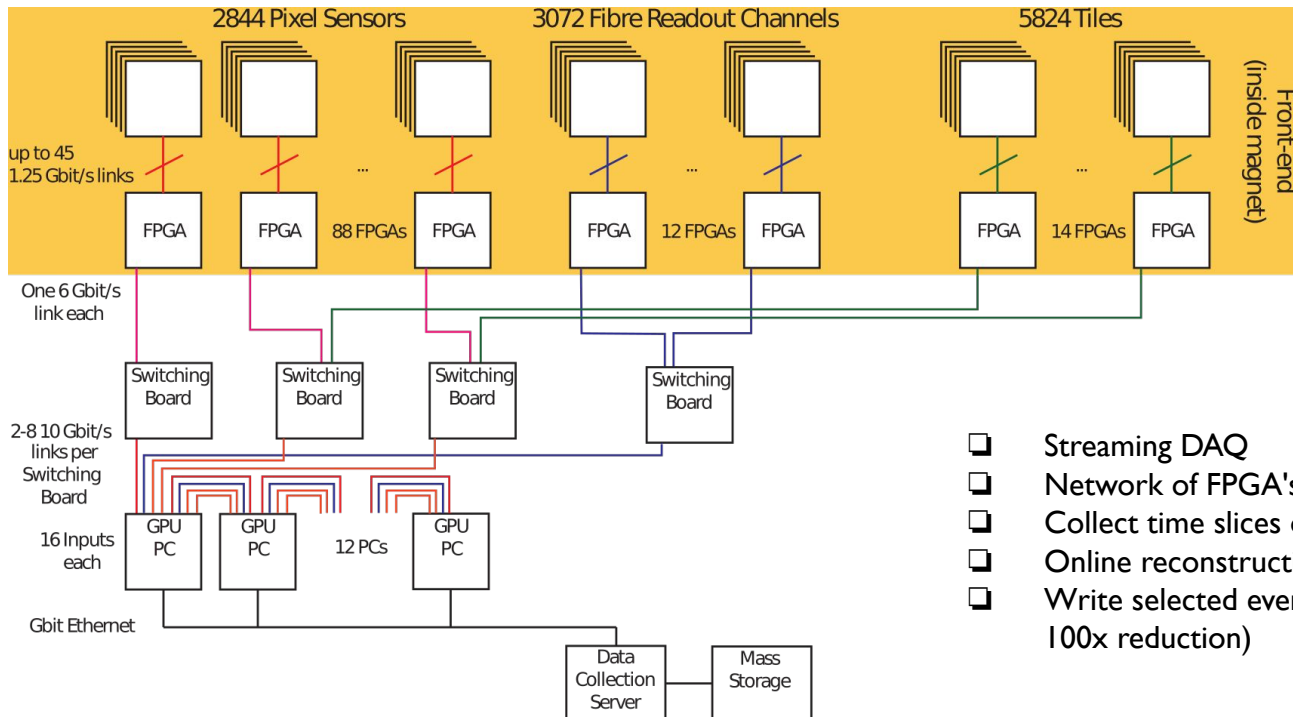

- ❑ Streaming DAQ
- ❑ Network of FPGA's and optical connections
- ❑ Collect time slices of the full detector on a single PC
- ❑ Online reconstruction and event selection on a GPUs
- ❑ Write selected events to disk at max 100 MB/s (up to 100x reduction)

Mu3e DAQ

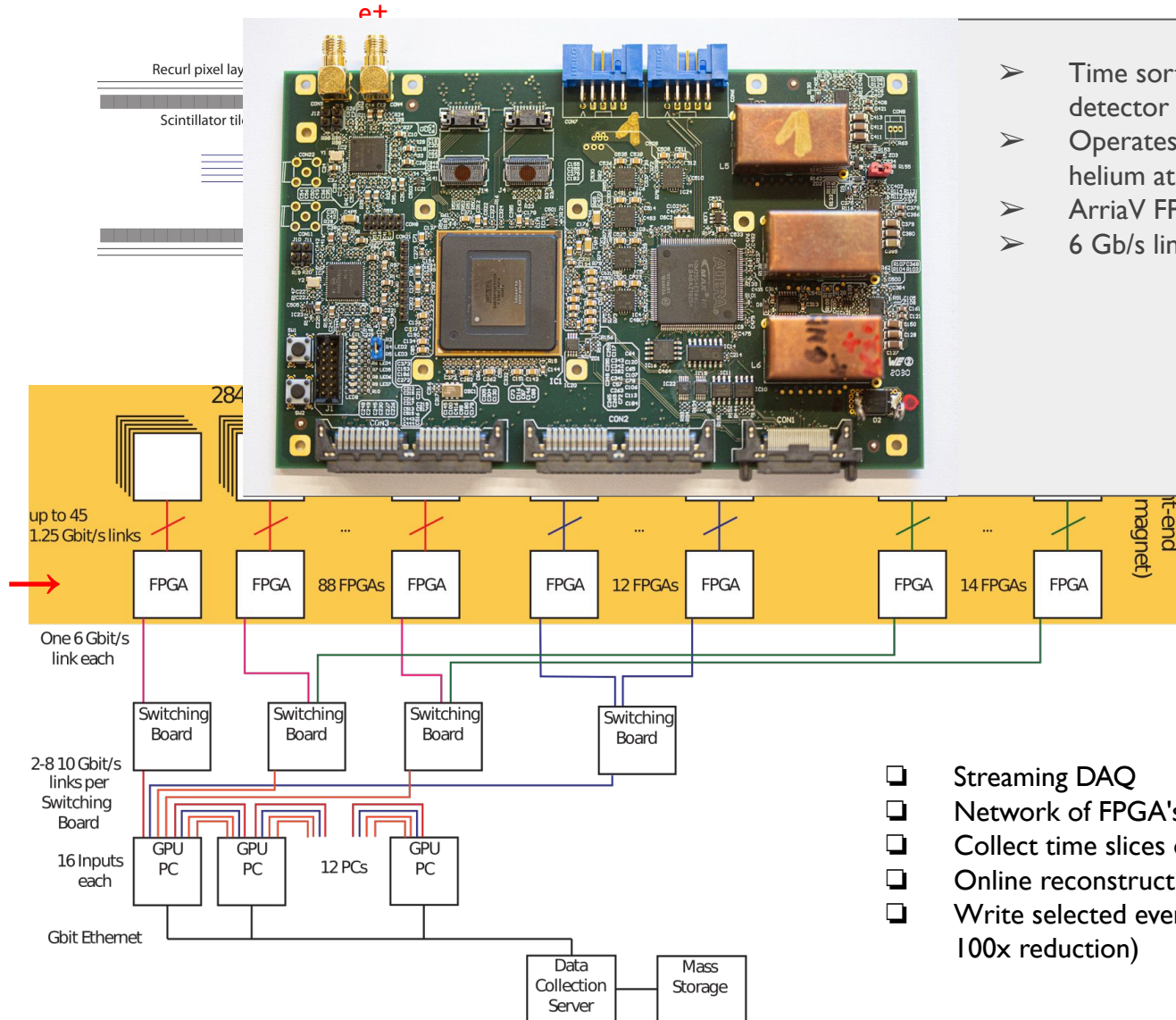

- Time sorting 45x1 MUX of the detector serial data
- Operates in magnetic field and helium atmosphere
- ArriaV FPGA
- 6 Gb/s link to the outside world

low for a RO
e part of a
combined final
criteria.

- ❑ Streaming DAQ
- ❑ Network of FPGA's and optical connections
- ❑ Collect time slices of the full detector on a single PC
- ❑ Online reconstruction and event on a GPUs
- ❑ Write selected events to disk at max 100 MB/s (up to 100x reduction)

Mu3e DAQ

et

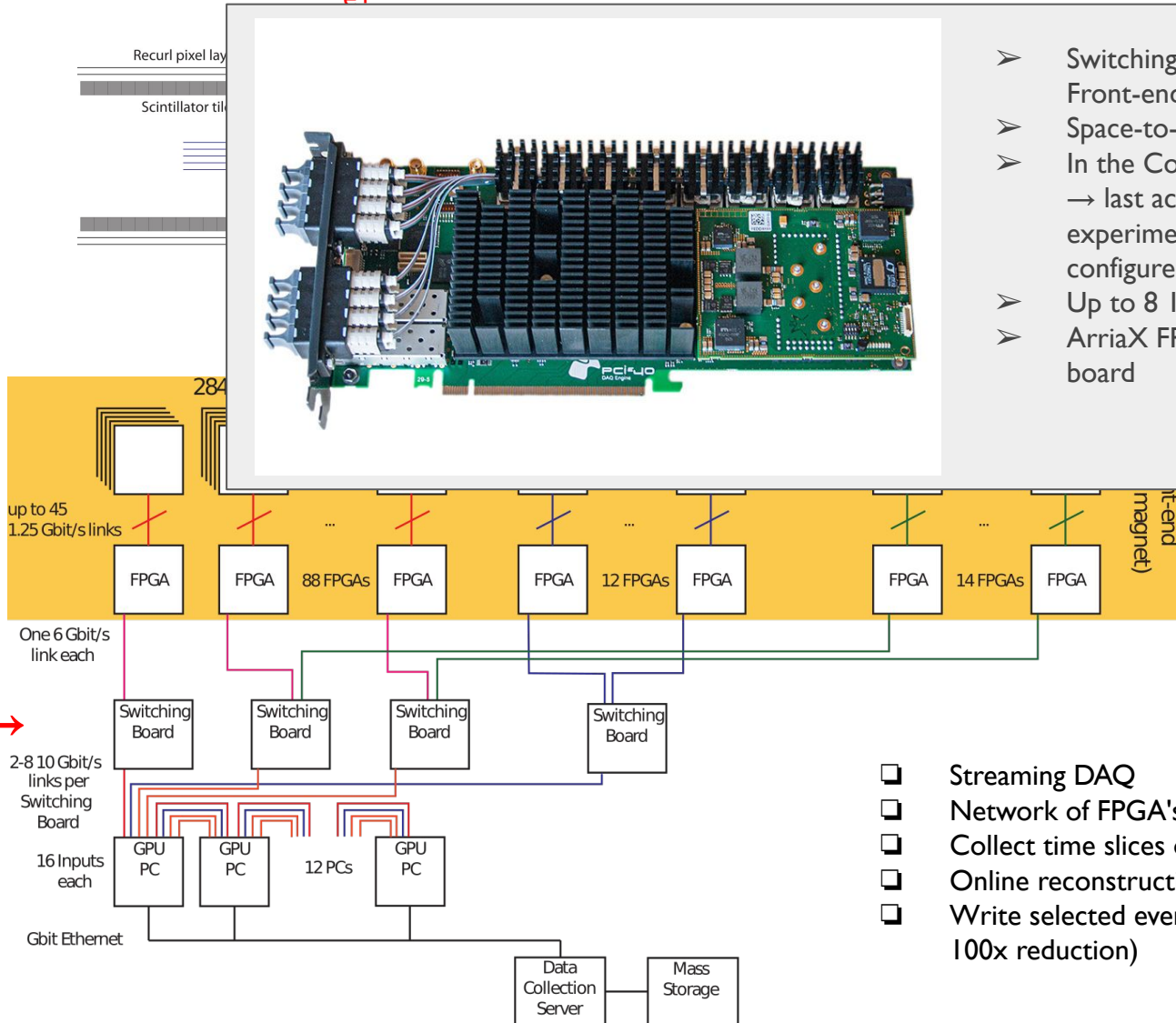

- Switching boards merging up to 37 Front-end board links
- Space-to-time slice transformation
- In the Counting house/inside a PC → last access point of the experiment through which e.g. we configure all the ASICs
- Up to 8 10Gb/s output links
- ArriaX FPGA on LHCb custom board

low for a RO
e part of a
combined final
criteria.

- ❑ Streaming DAQ
- ❑ Network of FPGA's and optical connections
- ❑ Collect time slices of the full detector on a single PC
- ❑ Online reconstruction and event on a GPUs
- ❑ Write selected events to disk at max 100 MB/s (up to 100x reduction)

Mu3e DAQ

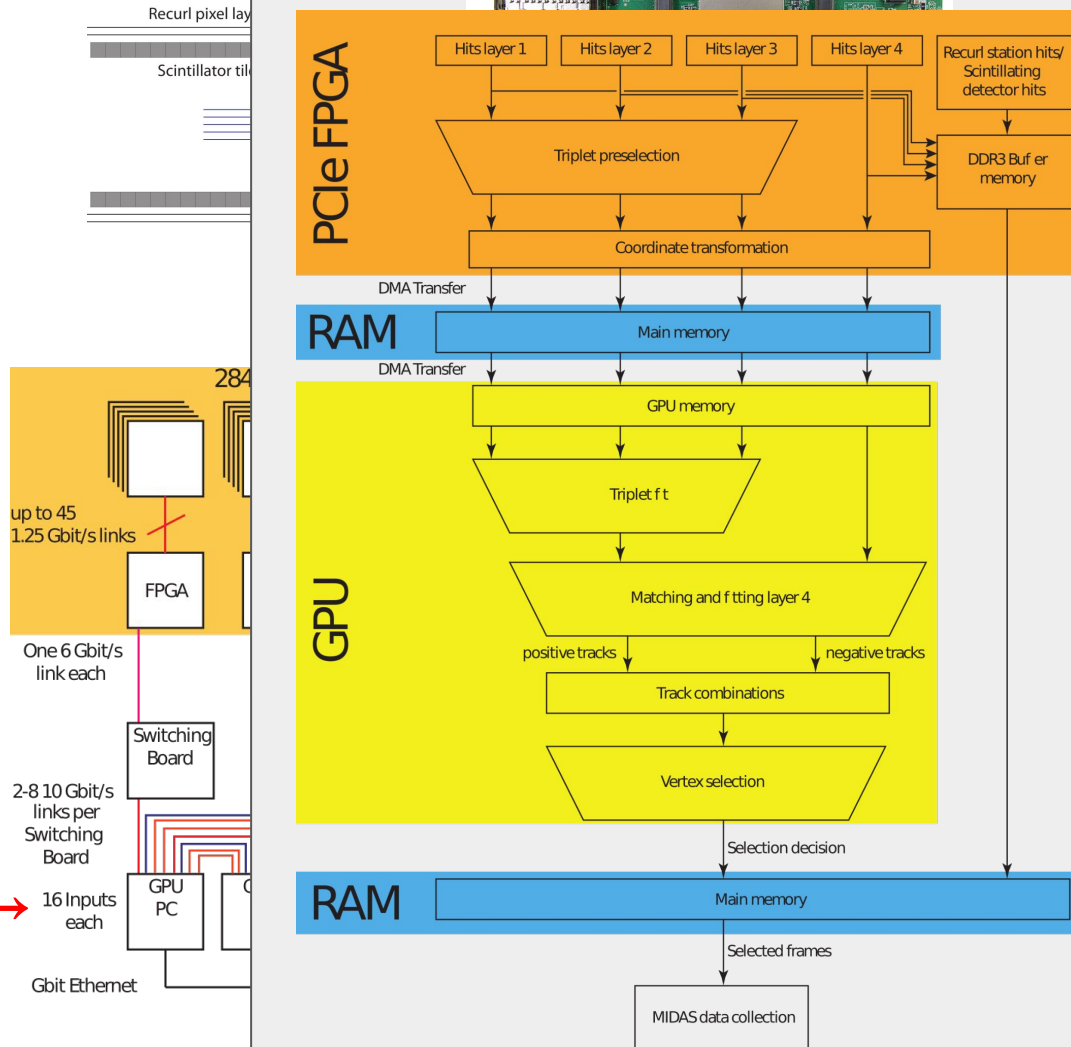

- Buffer all incoming data in DDR3 memory
- DMA of central tracker data to selection PC
- Run online event selection on GPU
- Over 10^9 track fits/s achieved per GPU achieved, we can handle $10^8 \mu/s$
- Selected events to disk



low for a RO
part of a
combined final
criteria.

PC
up to

Mu3e sensitivity

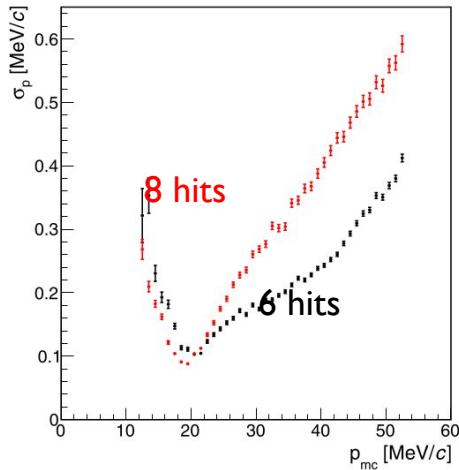

Based on full Monte Carlo simulation of the experiment, and an analytical track fitter <https://arxiv.org/abs/1606.04990>:

The Mu3e Phase I detector can achieve a $2 \cdot 10^{-15}$ SES on $\mu^+ \rightarrow e^+ e^+ e^-$

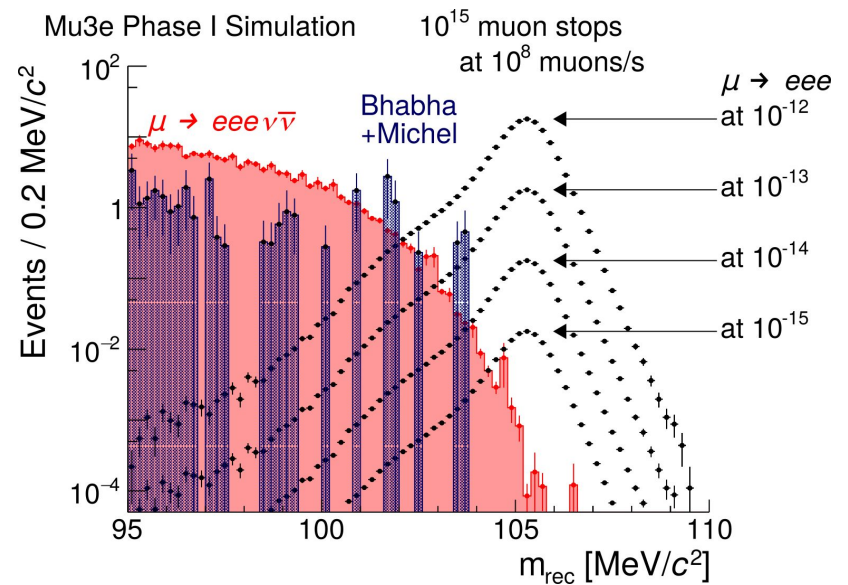
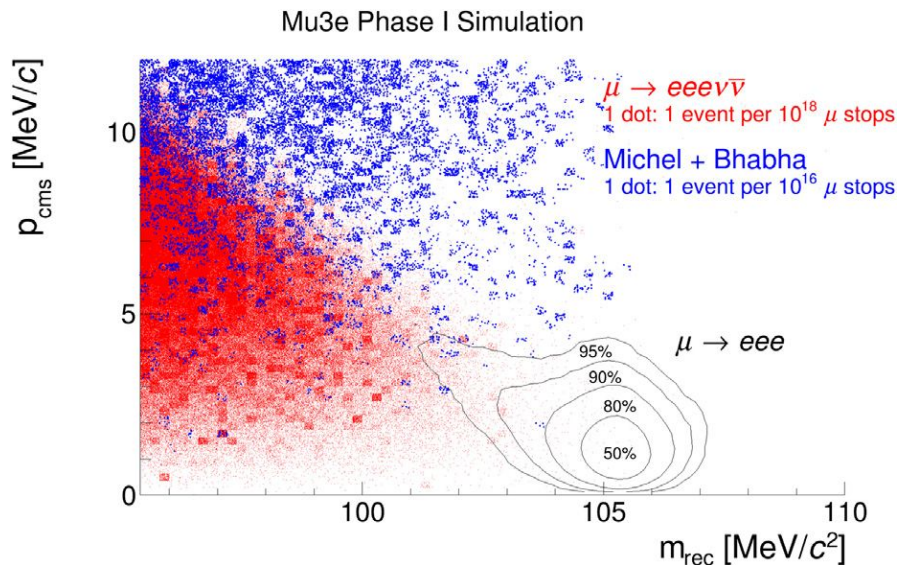

Mu3e sensitivity

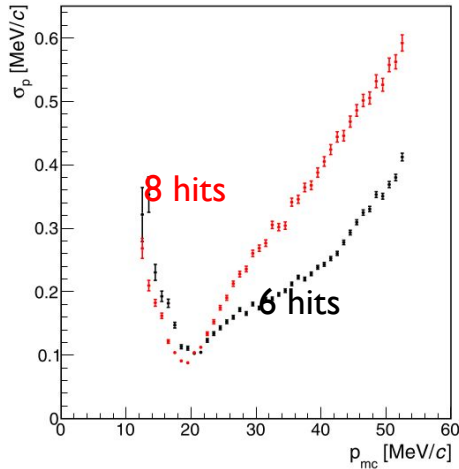

Based on full Monte Carlo simulation of the experiment, and an analytical track fitter <https://arxiv.org/abs/1606.04990>:

The Mu3e Phase I detector can achieve a $2 \cdot 10^{-15}$ SES on $\mu^+ \rightarrow e^+ e^+ e^-$

THE END?

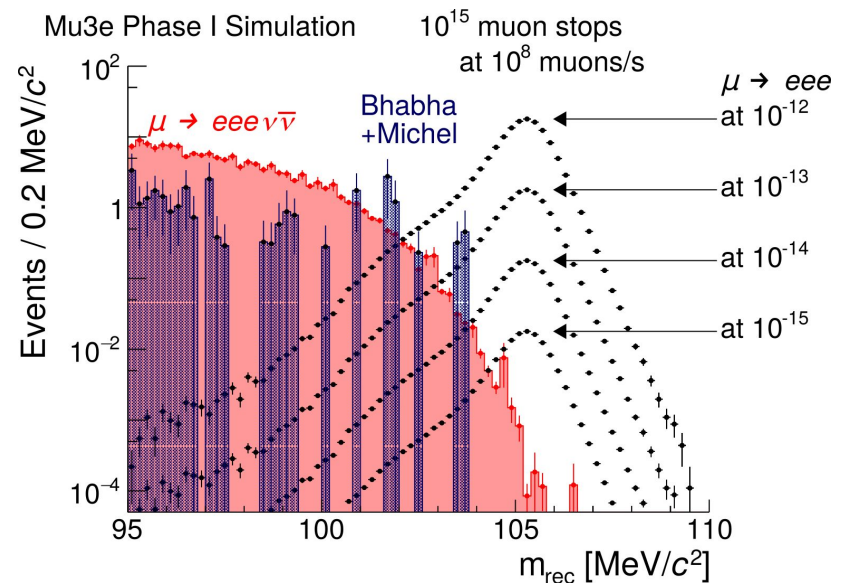
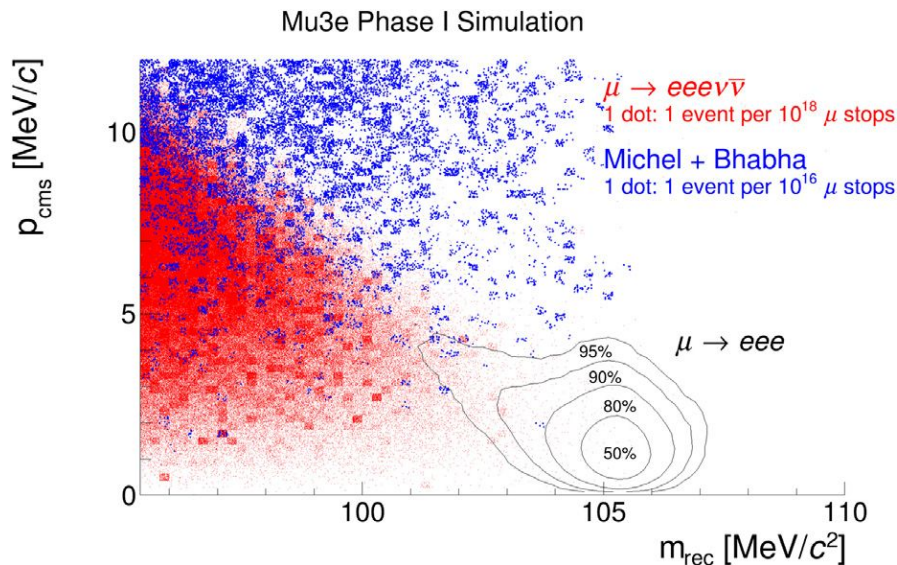

Mu3e detector construction & commissioning

All sensors work to specs

→ We have to build a very compact/complicated detector (+ services + DAQ)

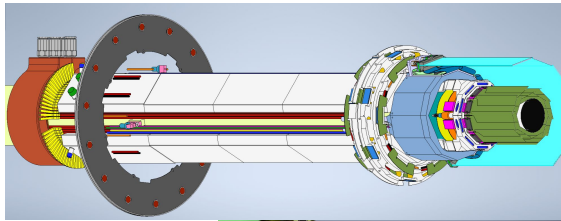

Detailed CAD

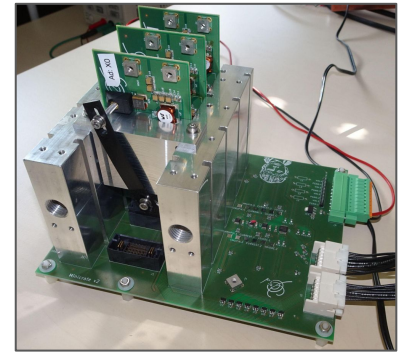
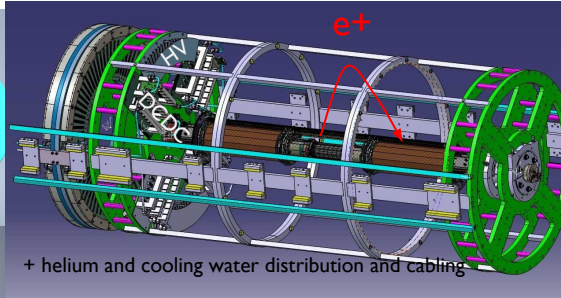
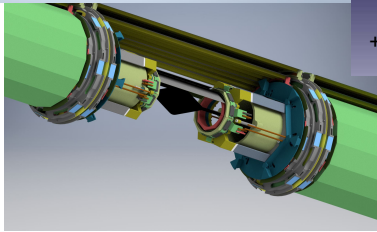

Custom DC-DC converters

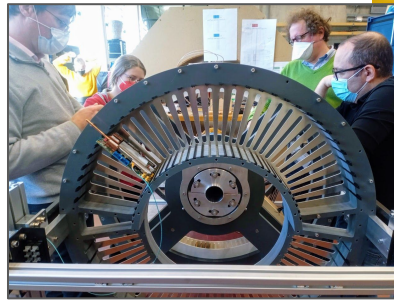

Mockup Mu3e in Heidelberg

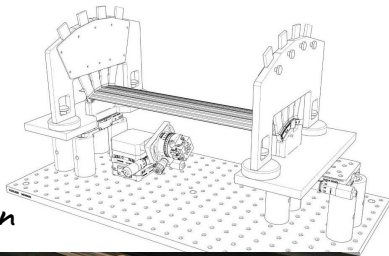
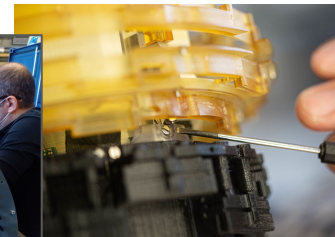

Tooling design

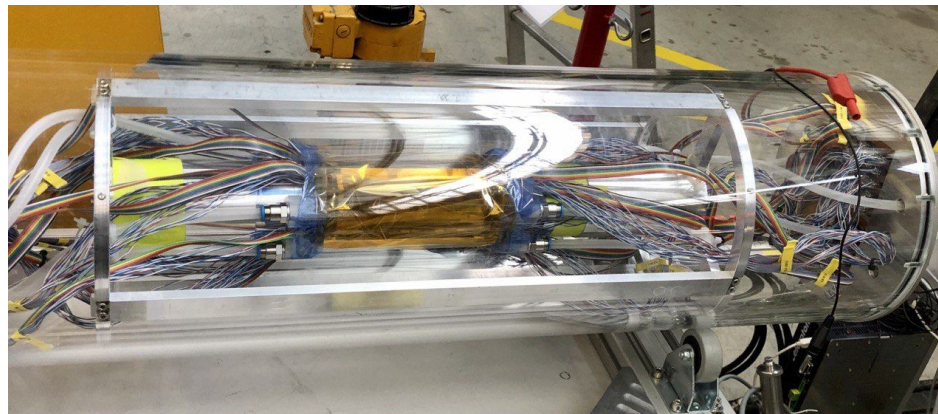
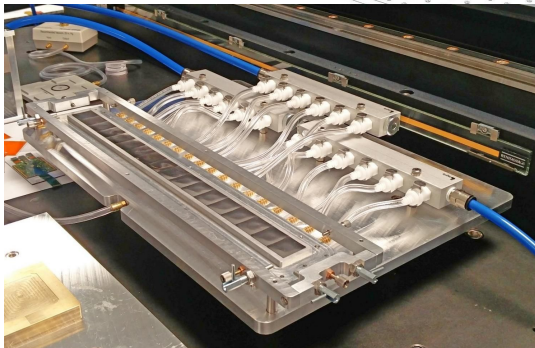

Thermo-mechanical mockup

Mu3e detector construction & commissioning

First we need a magnet and a beam line



Magnet parameter	Value
nominal field	1.0T
warm bore diameter	1.0m
warm bore length	2.7 m
field inhomogeneity $\Delta B/B$	$\leq 10^{-3}$
field stability $\Delta B/B$ (100 days)	$\leq 10^{-4}$
field measurement accuracy $\Delta B/B$	$\leq 2.0 \cdot 10^{-4}$
outer dimensions: length	≤ 3.2 m
width	≤ 2.0 m
height	≤ 3.5 m

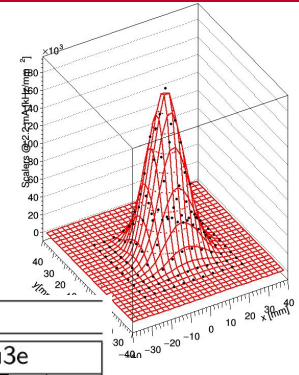
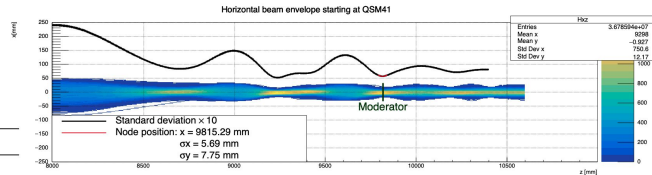

Beam Commissioning Comparison

Rates	Collimator	QSM41	Mu3e
2021	$2.11 \cdot 10^8 \mu^+/\text{s}$	$1.2 \cdot 10^8 \mu^+/\text{s}$	$4.76 \cdot 10^7 \mu^+/\text{s}$
2022	$2.47 \cdot 10^8 \mu^+/\text{s}$	$1.8 \cdot 10^8 \mu^+/\text{s}$	$7.46 \cdot 10^7 \mu^+/\text{s}$

Table: All rates are normalised to 2.4 mA.

30T magnet arrives at PSI



We are at the *Compact muon beamline* because we have to share $\pi E5$ with the MEG experiment

Mu3e detector construction & commissioning

We need services such as gaseous helium cooling, liquid cooling, power, high-voltage, ...

Novel 50 g/s, 5 kW helium cooling system

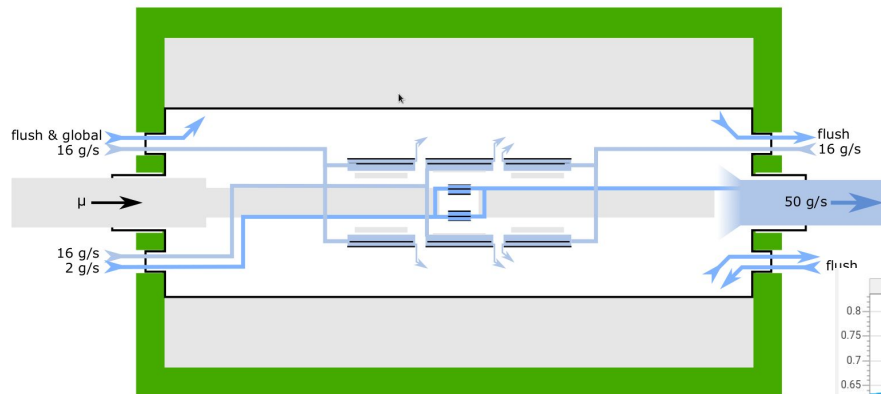
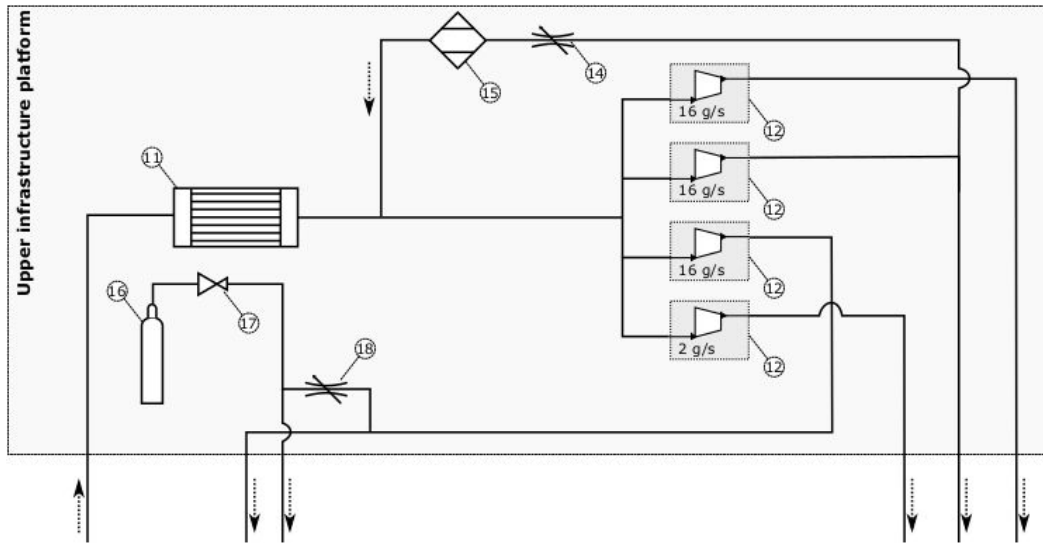

Custom HV boards

+ Liquid cooling under design. $SipM < -10C$

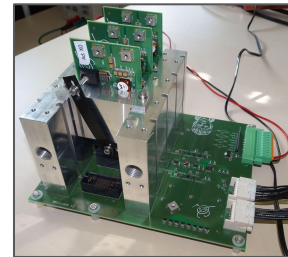

Custom DCDC boards

- 30A
- Magnetic field

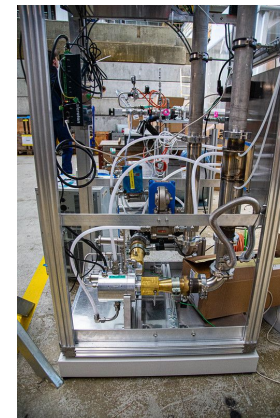

operated 2/g system with vertex detector for 3 months

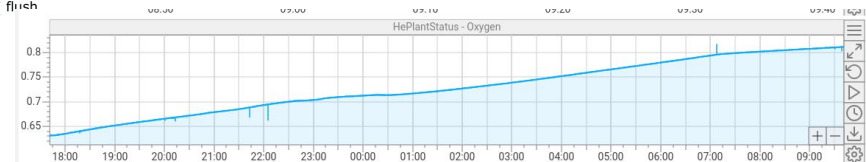

Mu3e detector construction & commissioning

Demonstrator vertex & SciFi detector: 2021 and 2020 commissioning runs

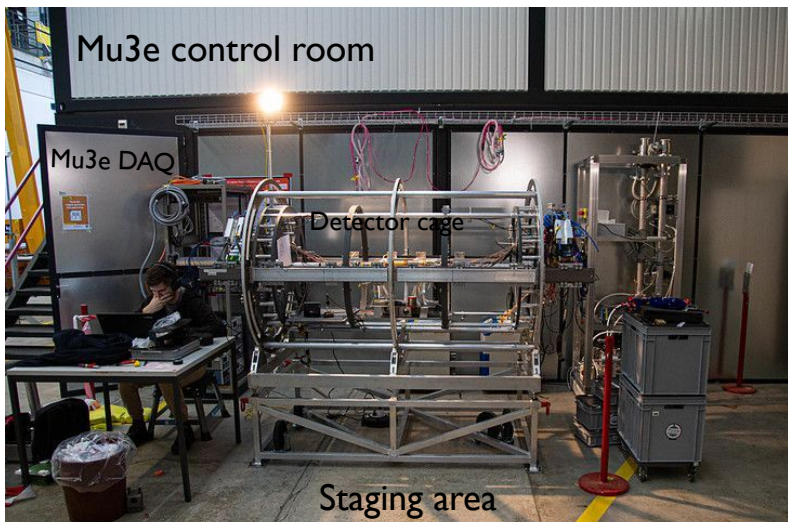
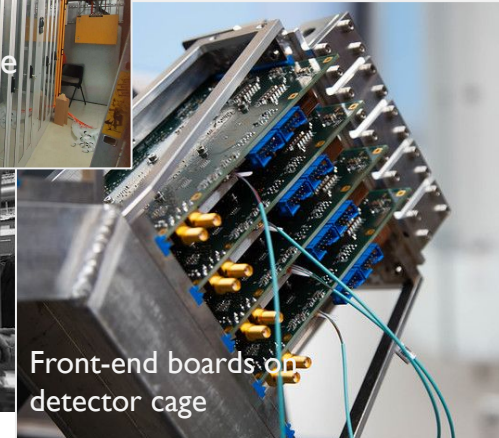

Mu3e detector construction & commissioning

Demonstrator vertex & SciFi detector: 2021 and 2020 commissioning runs

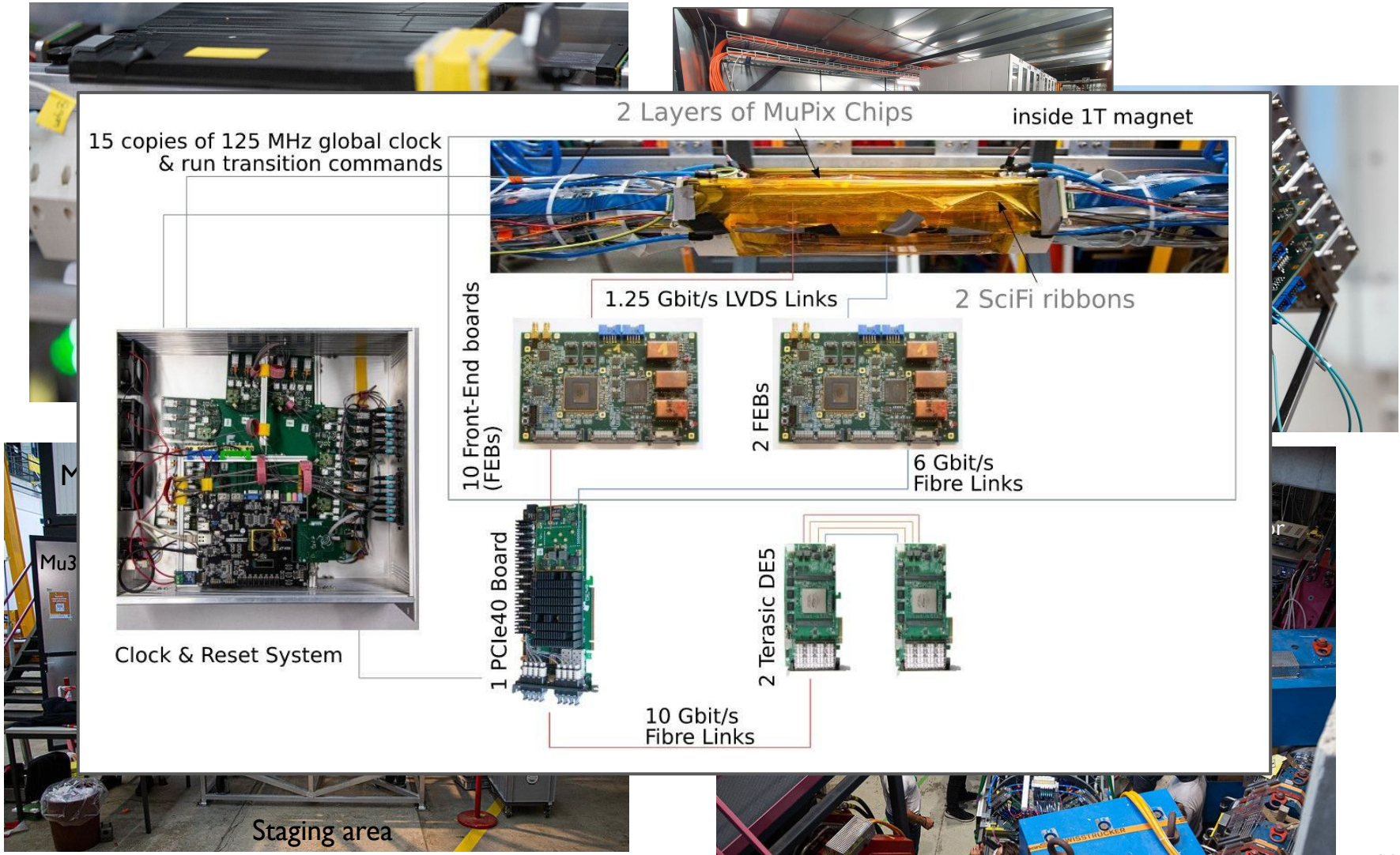

Mu3e detector construction & commissioning

Demonstrator vertex & SciFi detector: 2021 and 2020 commissioning runs

Synch SciFi and Pixel detector, QC test, Cosmic tracks detection, DAQ integration

First beam on target, first recurl positrons detected in magnet

Cosmic track

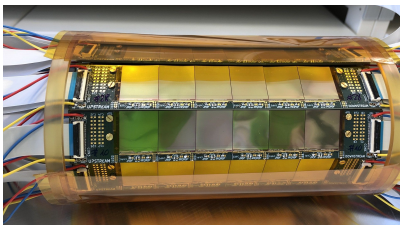
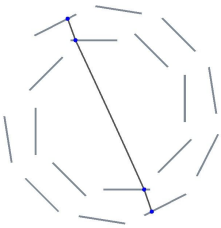
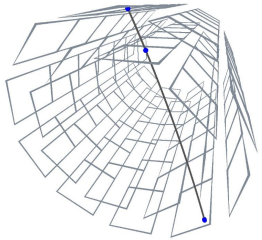

Pixel-SciFi coincidences

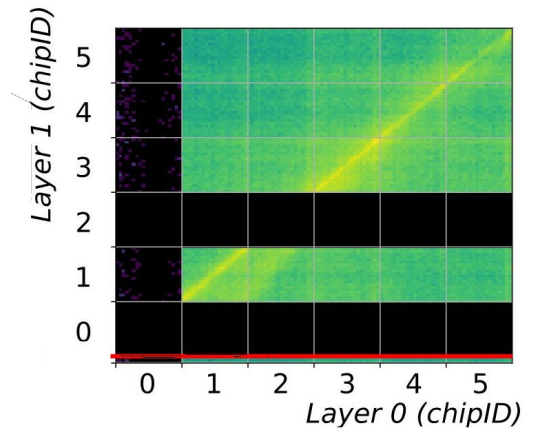
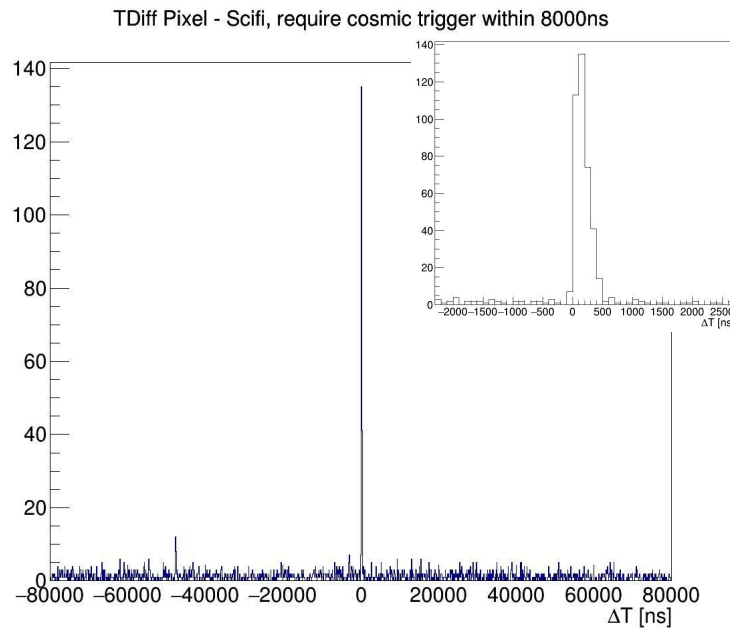

Strong correlation between layer 0 & 1 fuzziness because of recurlers

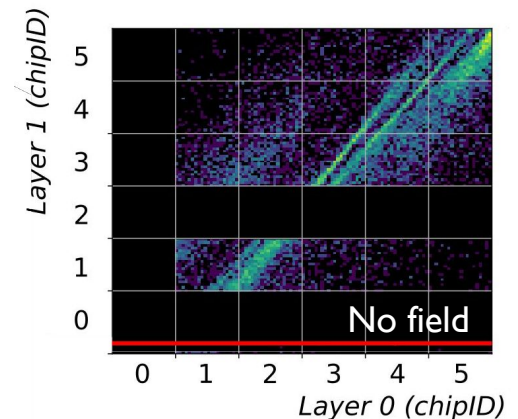

So what's next?

- ❑ Final pixel modules:
 - ❑ Alu-Kapton flex
 - ❑ MuPix 11 chip

*Being wafer-tested,
dices, and thinned*



- ❑ Final timing detectors
 - ❑ MuTrig 3 chip end of summer
 - ❑ RO modules being produced
- ❑ Services installation
 - ❑ DC-DC modules under production
 - ❑ He system 2g/s → 50 g/s
 - ❑ Electronics cooling < 0C detector cooling

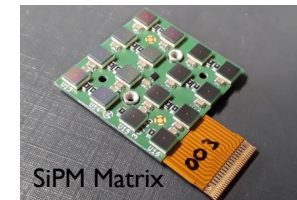
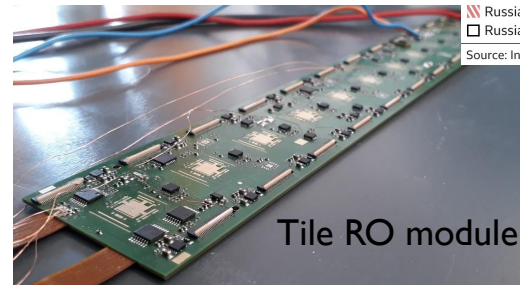

Areas of Russian military control in Ukraine

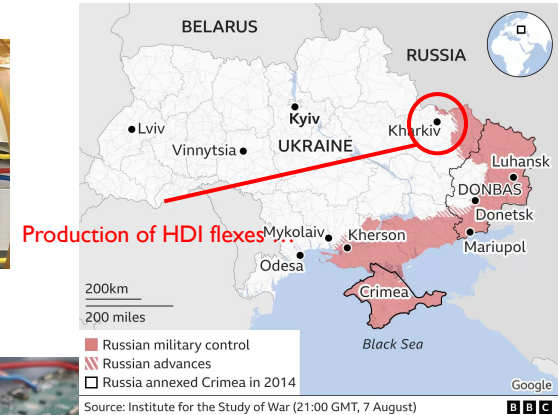

- ❑ Build the Phase I Mu3e detector in steps in our staging area (2022/2023)
- ❑ Full Commissioning in 2024
- ❑ Physics data taking in 2025-2026 of the Mu3e Phase I experiment, reaching SES of $2 \cdot 10^{-15}$ on $\mu^+ \rightarrow e^+ e^+ e^-$

Nuclear Inst. and Methods in Physics Research, A 1014 (2021) 165679



Contents lists available at ScienceDirect
Nuclear Inst. and Methods in Physics Research, A

journal homepage: www.elsevier.com/locate/nima



So what's next?

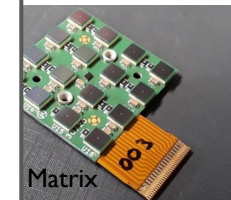
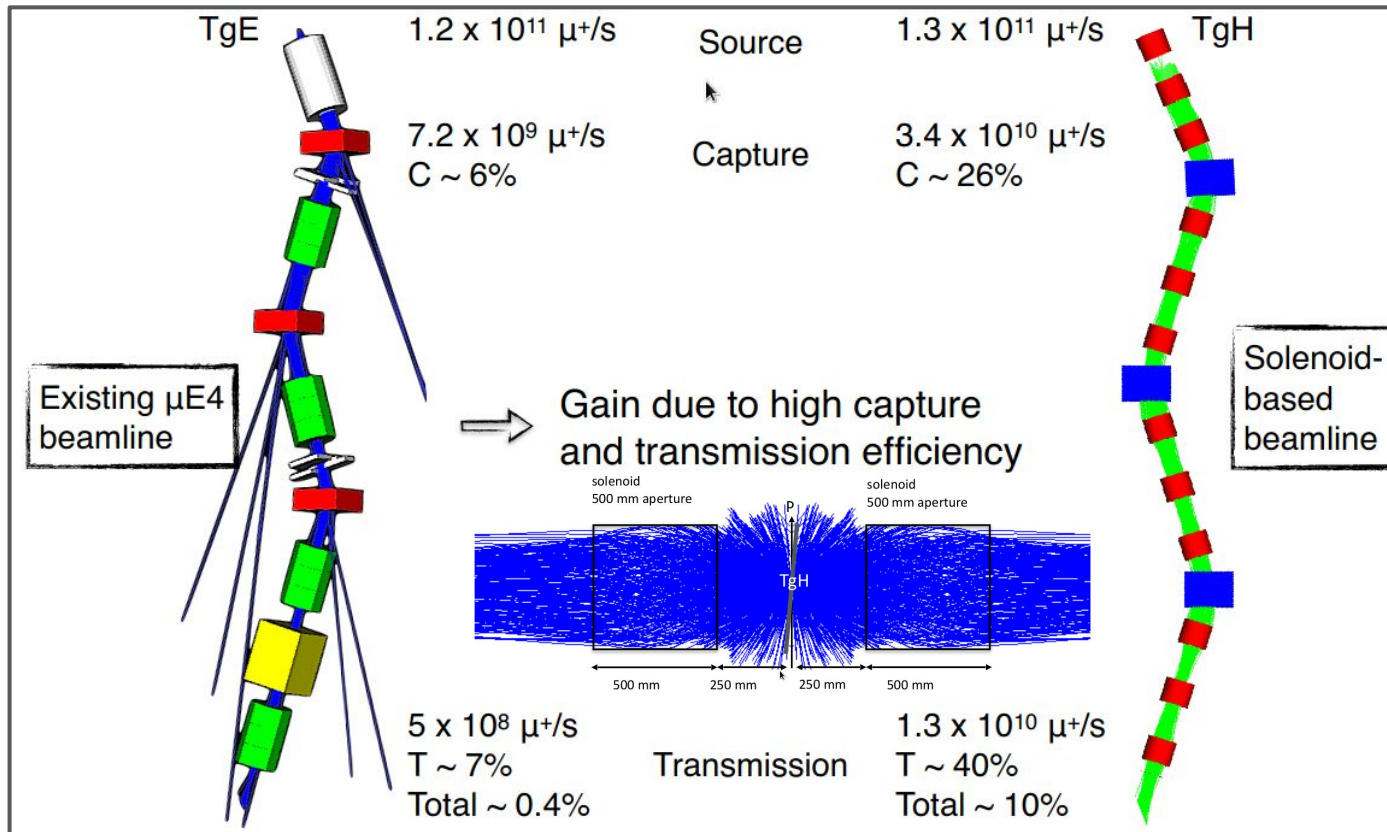

- ❑ Full Commissioning in 2024
- ❑ Physics data taking in 2025-2026 of the Mu3e Phase I experiment, reaching SES of $2 \cdot 10^{-15}$ on $\mu^+ \rightarrow e^+ e^+ e^-$
- ❑ HiMB upgrade in 2027-2028, start preparing Mu3e Phase II aiming for $1 \cdot 10^{-16}$

Nuclear Inst. and Methods in Physics Research, A 1014 (2021) 165679



Contents lists available at ScienceDirect

Nuclear Inst. and Methods in Physics Research, A

journal homepage: www.elsevier.com/locate/nima



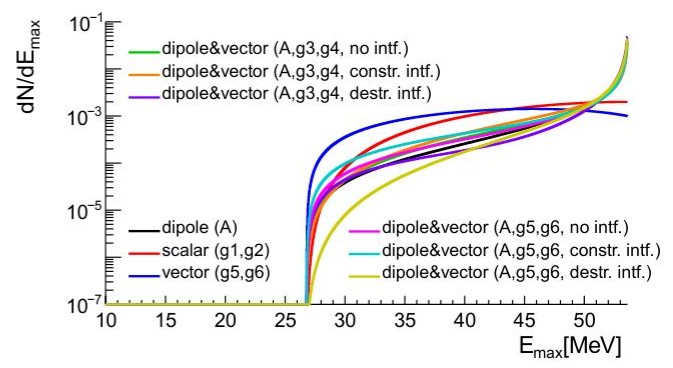
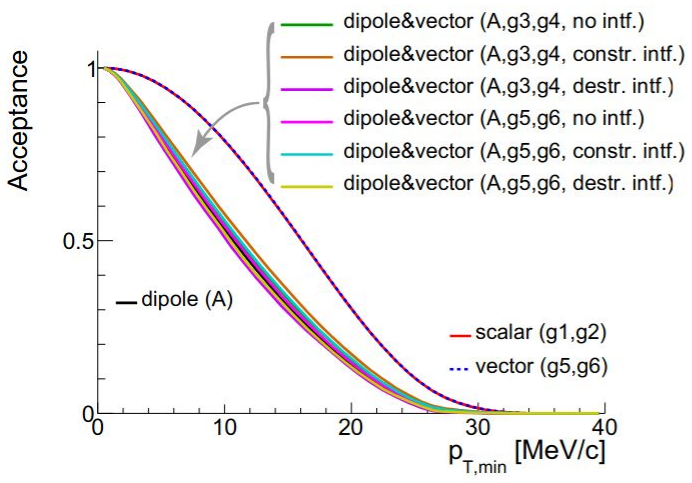
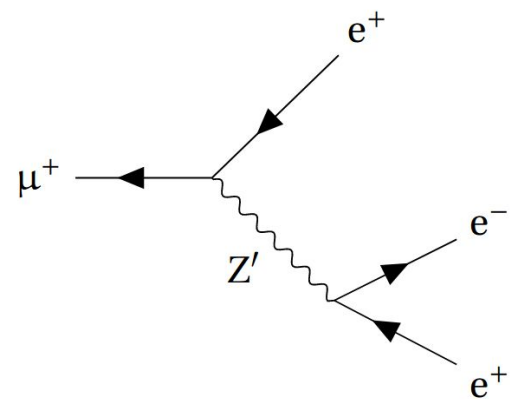
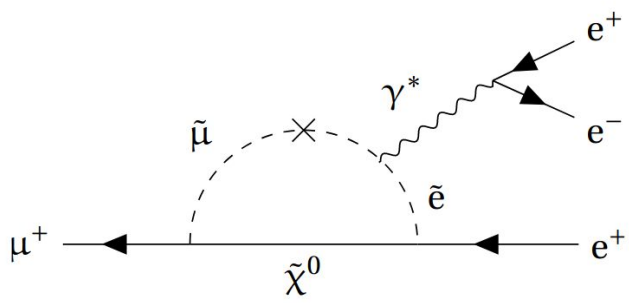
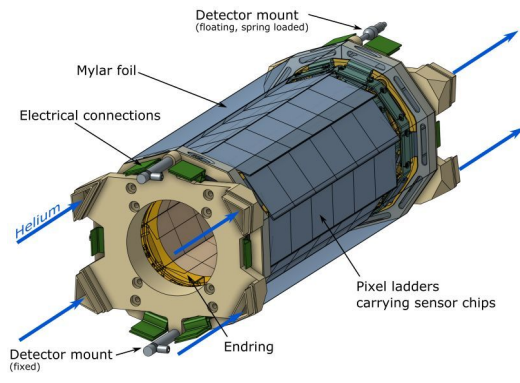
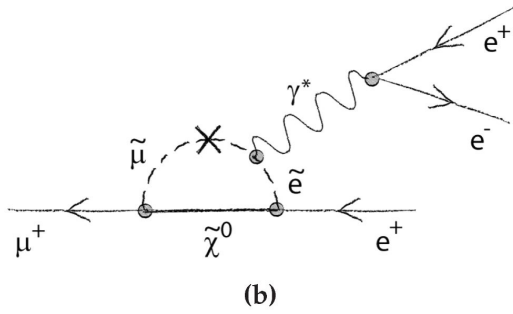
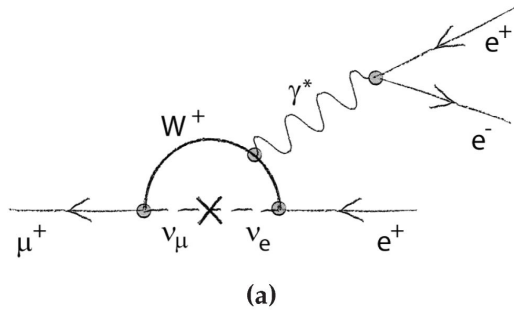

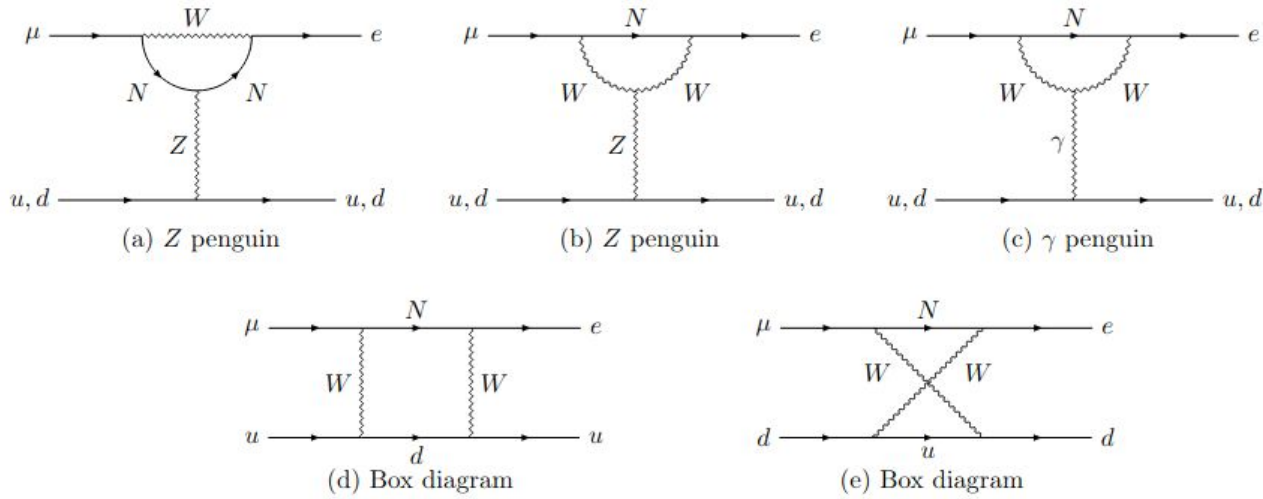

FIG. 1. One-loop diagrams contributing to the $\mu \rightarrow e$ conversion process, including 2 HNL “penguin” diagrams (a). Diagrams containing HNLs that dress external lines are not shown (see [24, 68–71] for the full list of such diagrams).

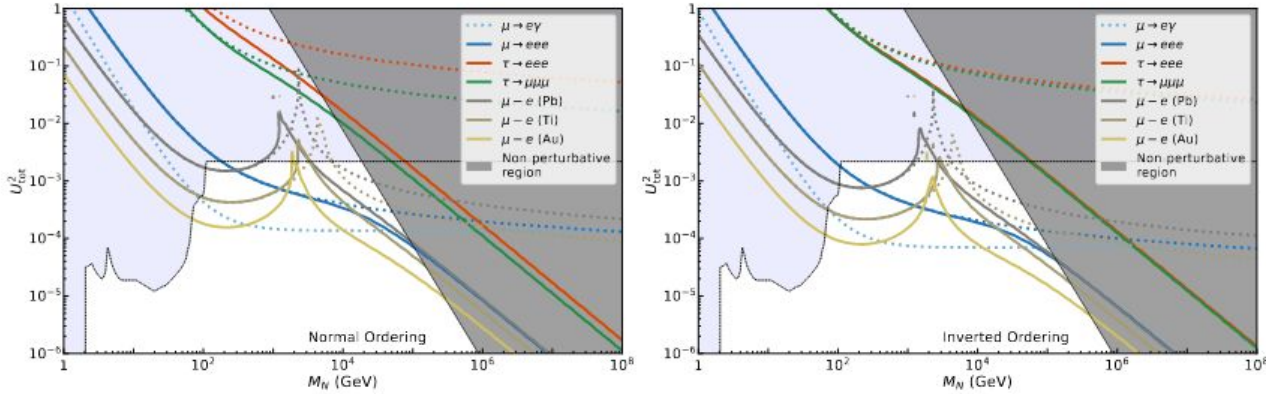
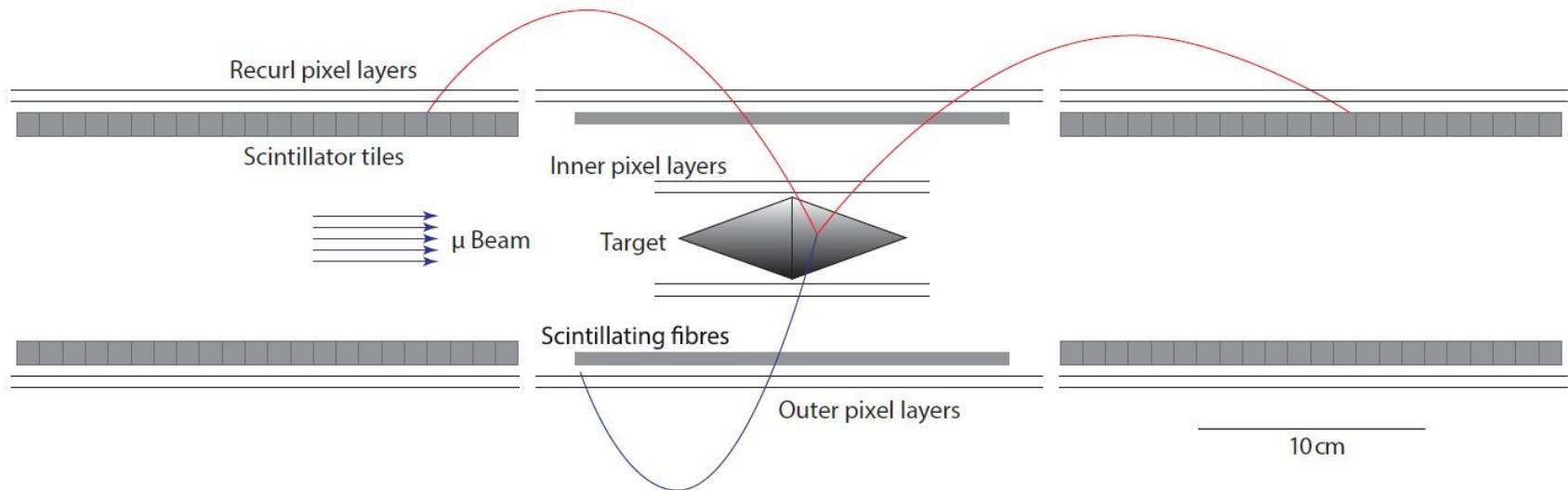
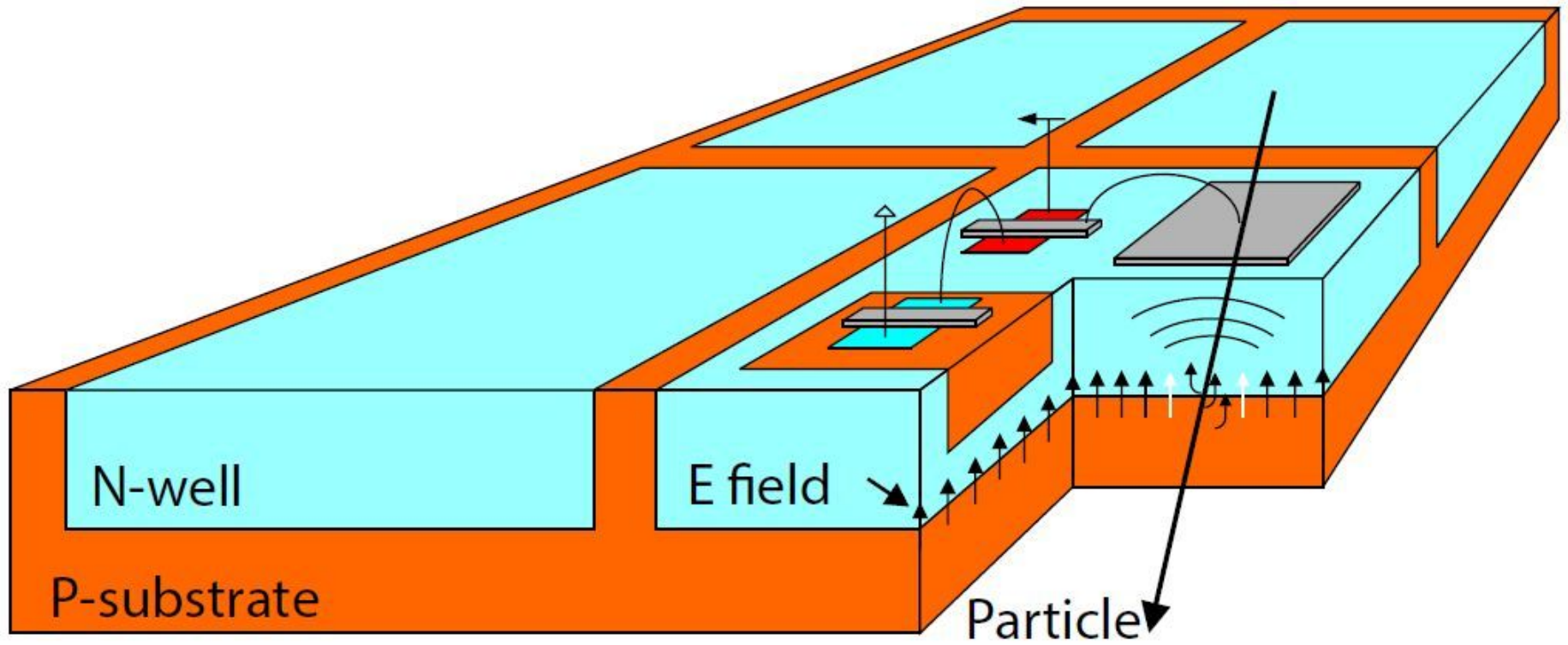
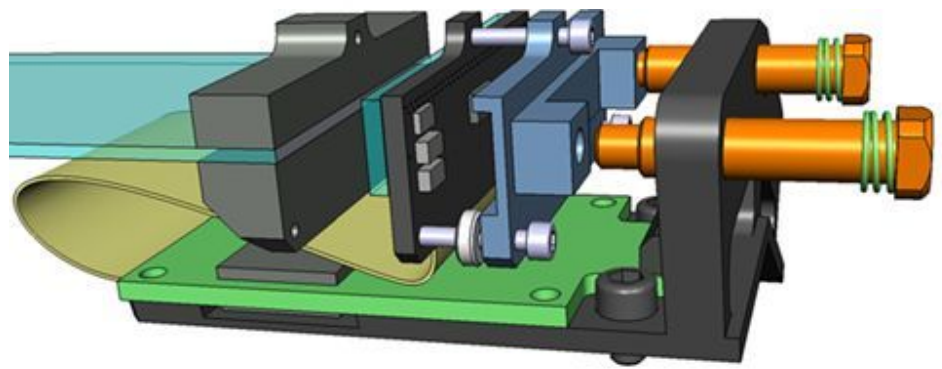
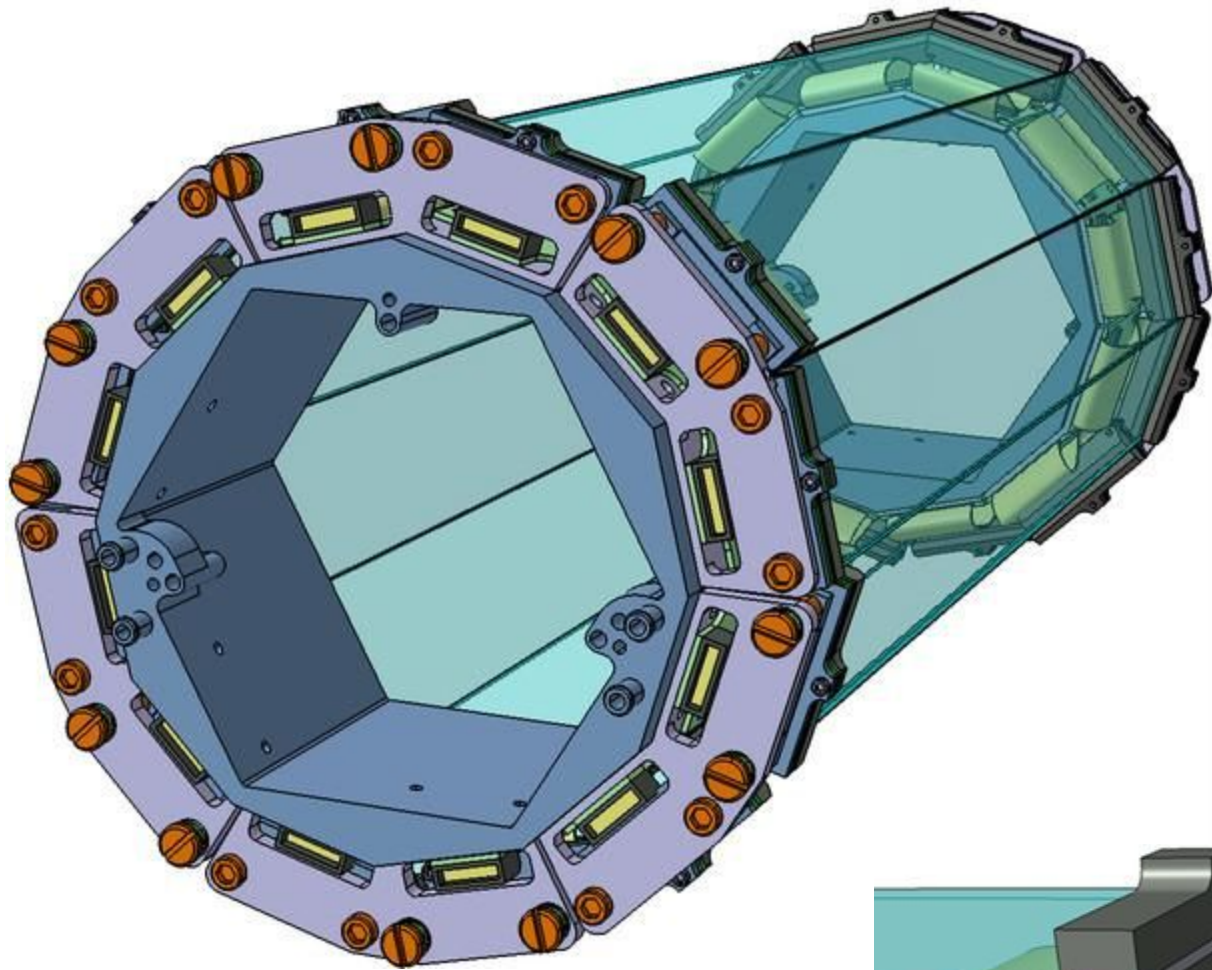
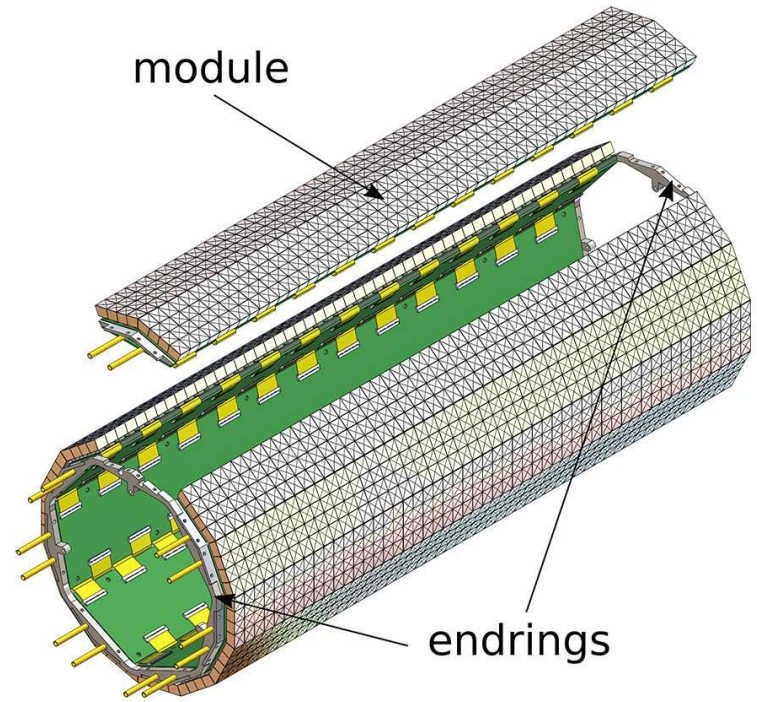
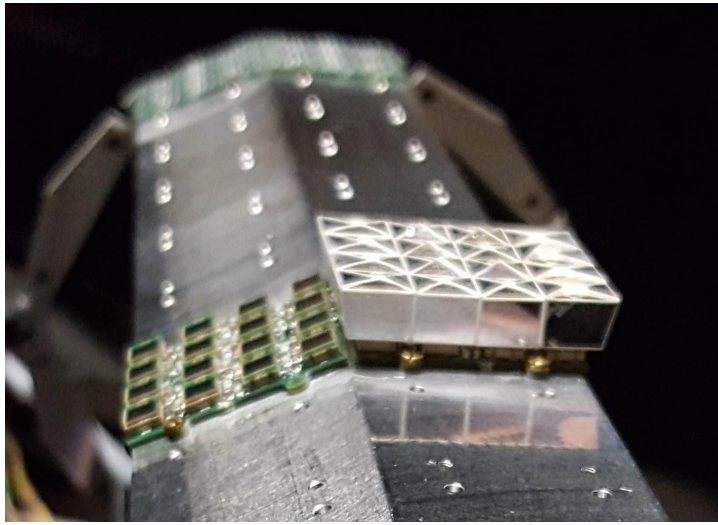

FIG. 2. Improved experimental limits on HNLs coupling from charged lepton flavor violation processes (solid lines). The strongest bound comes from the $\mu \rightarrow e$ conversion in gold [72]. Blue shaded region: previous constraints, not including cLFV. Gray shaded region: non-perturbative regime (see text for details). Dotted lines: previous cLFV constrains from the works [56, 59, 60, 67, 73]. Results are expressed in terms of U_{tot}^2 for flavor ratios (4), see text for details.

<https://arxiv.org/abs/2206.04540>







Gouvea and Vogel [arXiv:1303.4097](https://arxiv.org/abs/1303.4097)

Kuno Muon decay SM and BSM [arXiv:hep-ph/9909265](https://arxiv.org/abs/hep-ph/9909265)

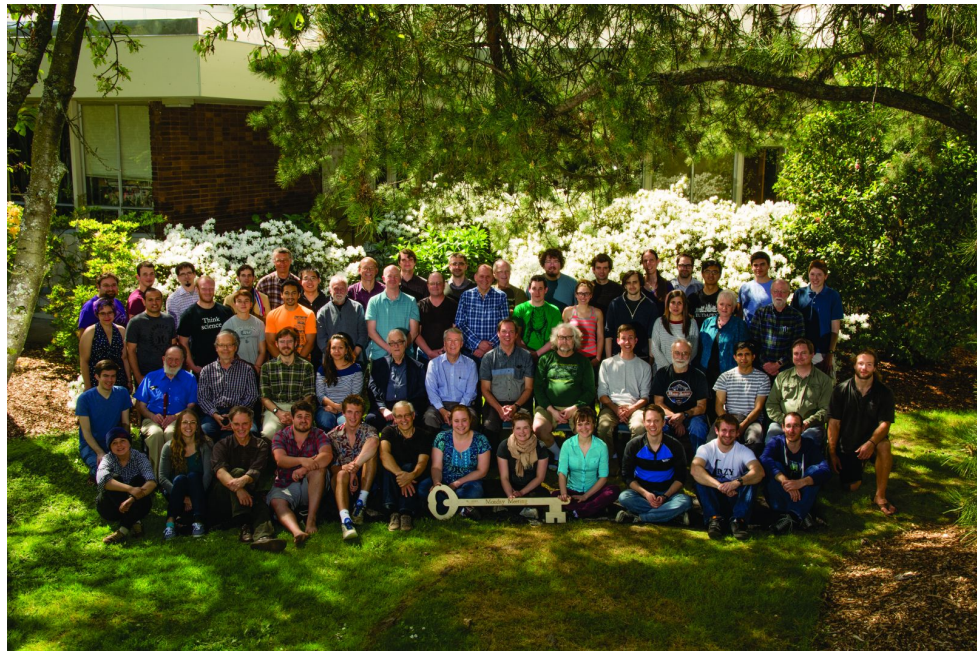

<https://www.youtube.com/watch?v=IlC8ioxToZg>

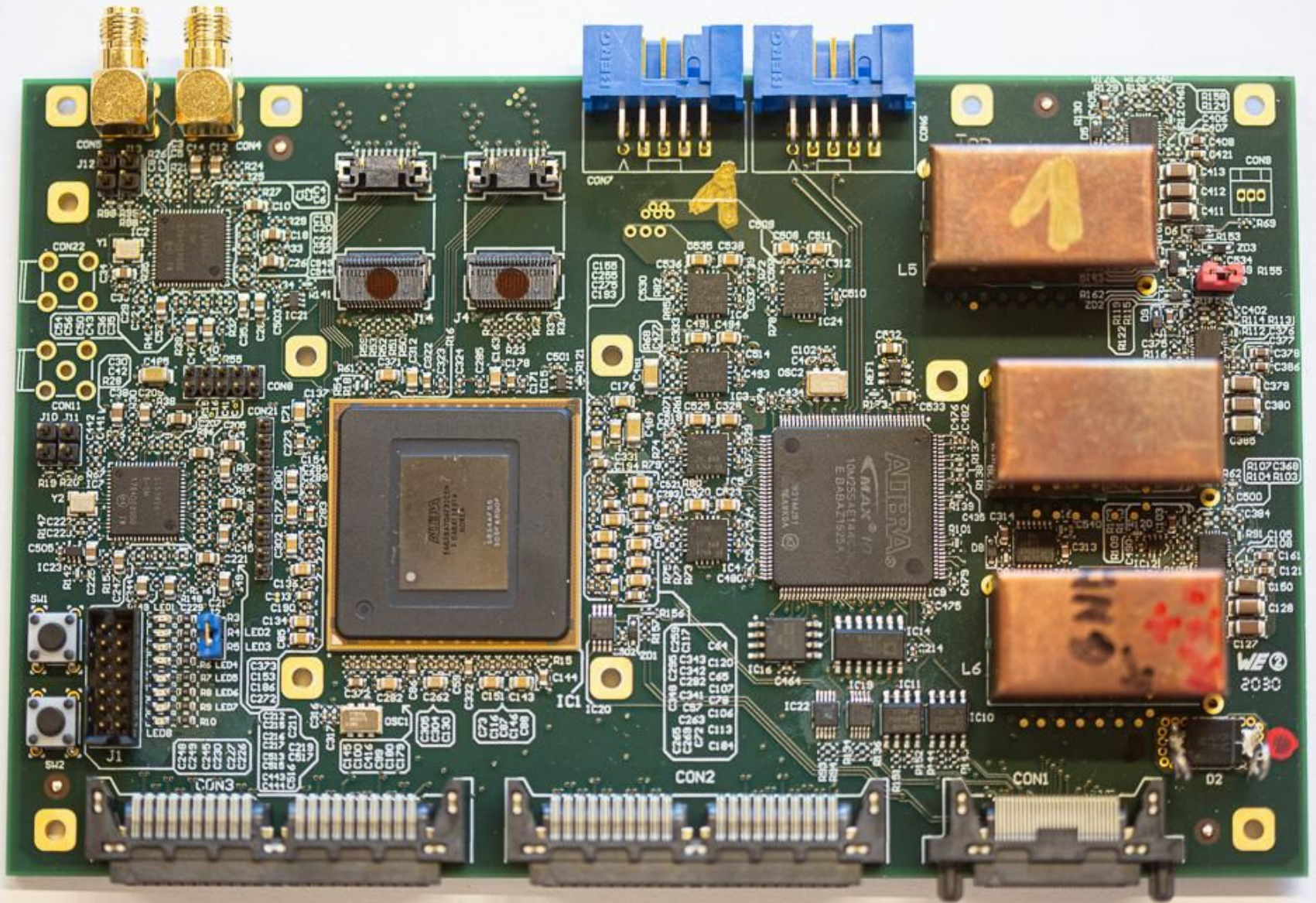

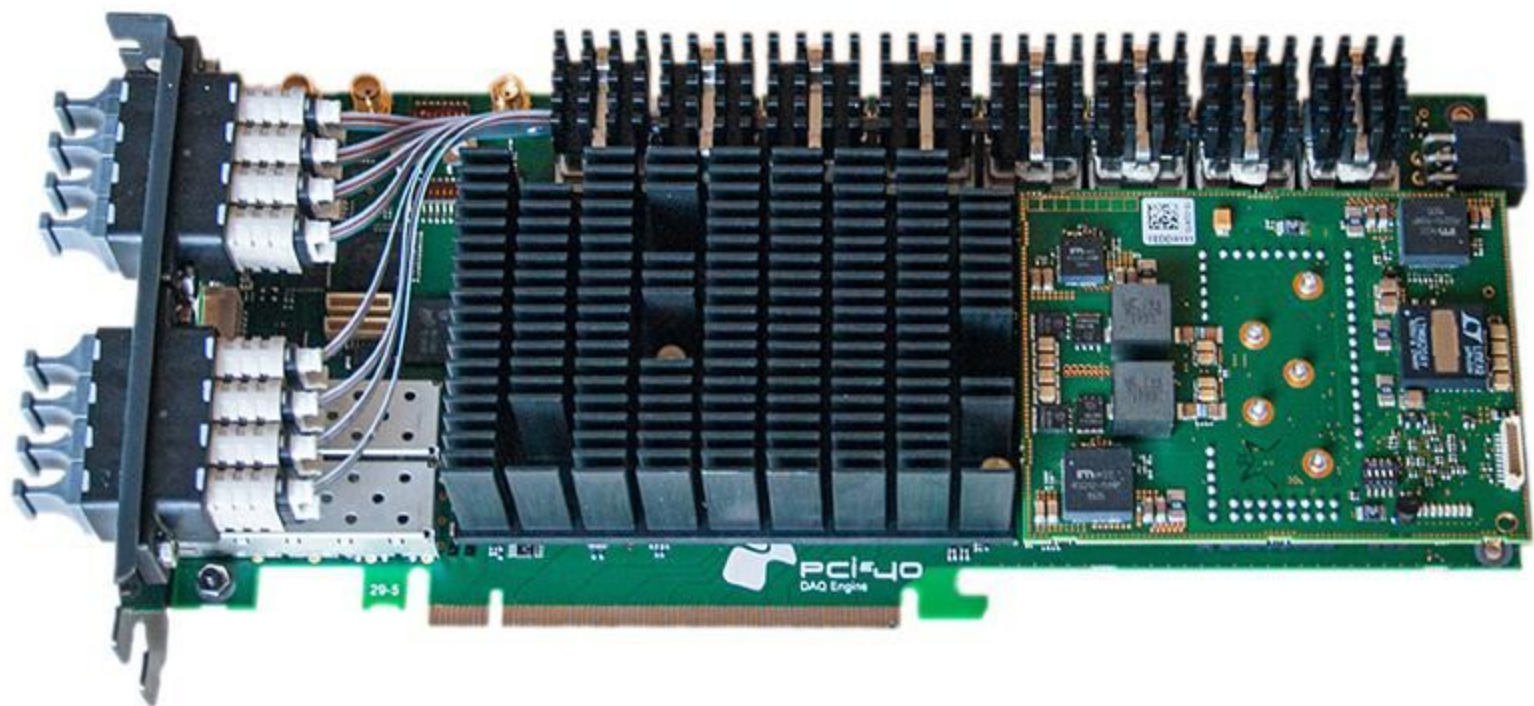

20mm

3mm

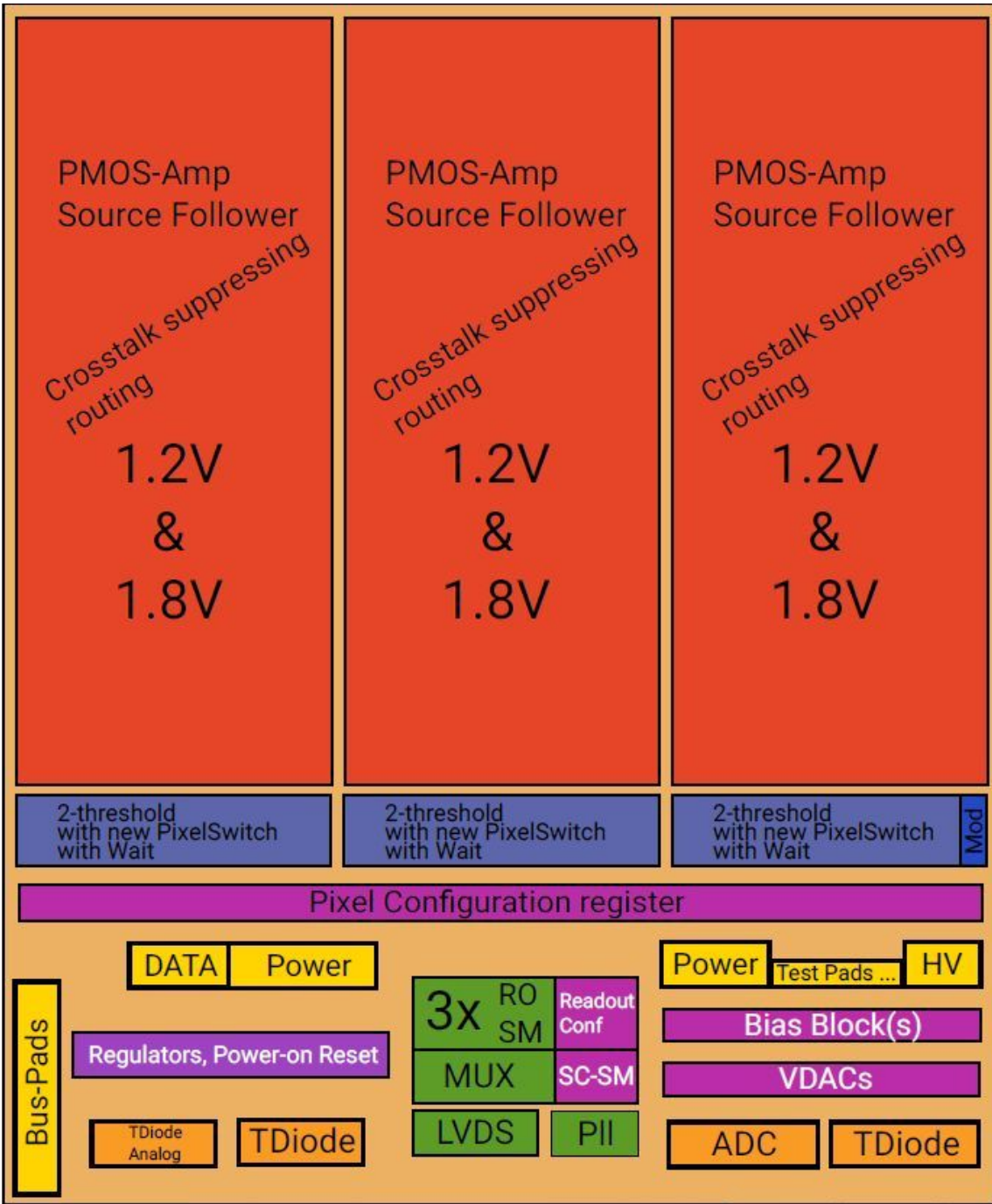

High Rate & Continuous Readout

MuPix

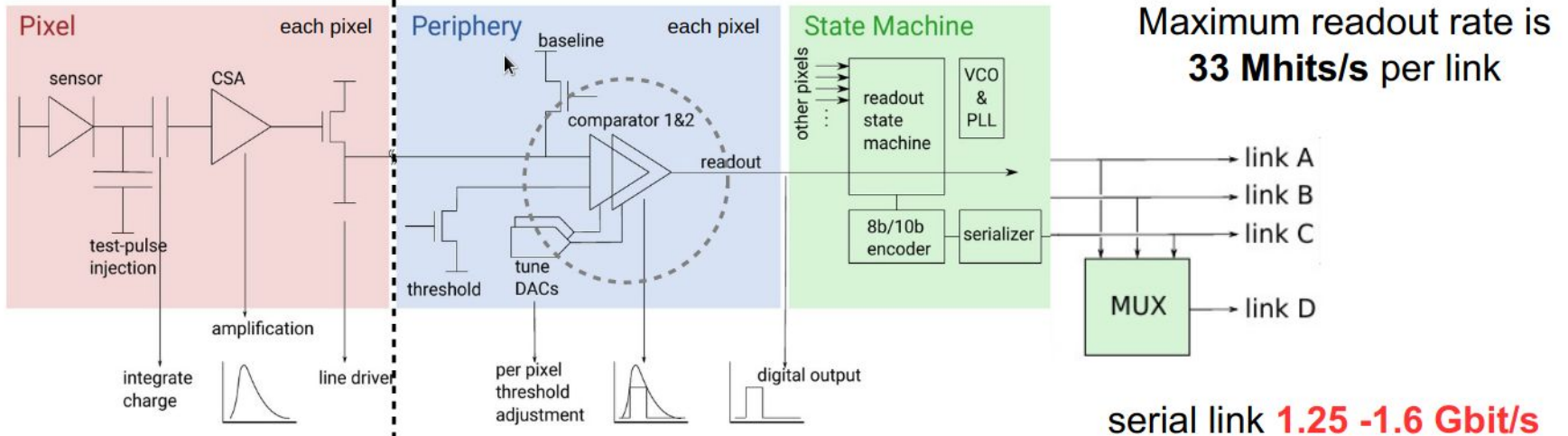

serial link **1.25 -1.6 Gbit/s**

MuPix8 sensor



periphery & SM

eye diagram

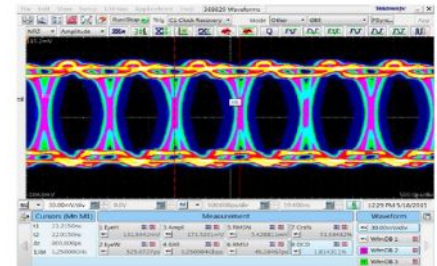

MuPix series is the first monolithic pixel sensor with continuous sampling and readout!

Possible Contributions to CLFV

Supersymmetry

rate $\sim 10^{-15}$

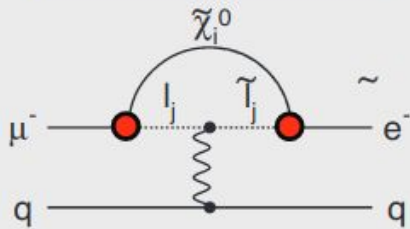

Compositeness

$\Lambda_c \sim 3000 \text{ TeV}$

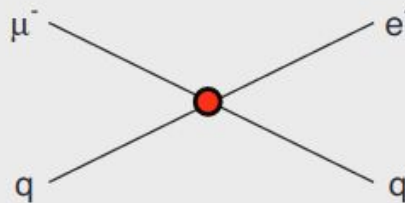

Leptoquark

$M_{LQ} = 3000 (\lambda_{\mu d} \lambda_{ed})^{1/2} \text{ TeV}/c^2$

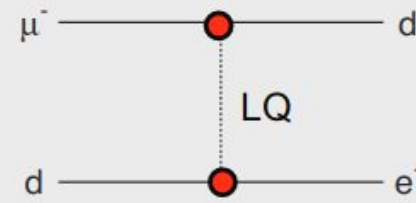

Heavy Neutrinos

$|U_{\mu N} U_{eN}|^2 \sim 8 \times 10^{-13}$

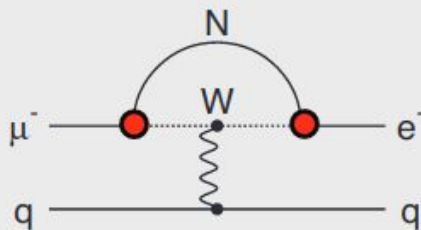

Second Higgs Doublet

$g(H_{\mu e}) \sim 10^{-4} g(H_{\mu\mu})$

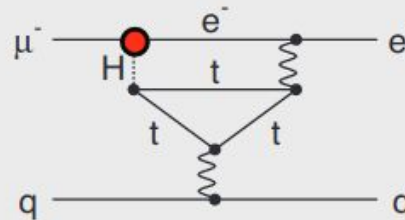

Heavy Z' Anomal. Z Coupling

$M_{Z'} = 3000 \text{ TeV}/c^2$

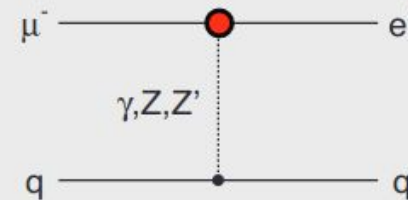

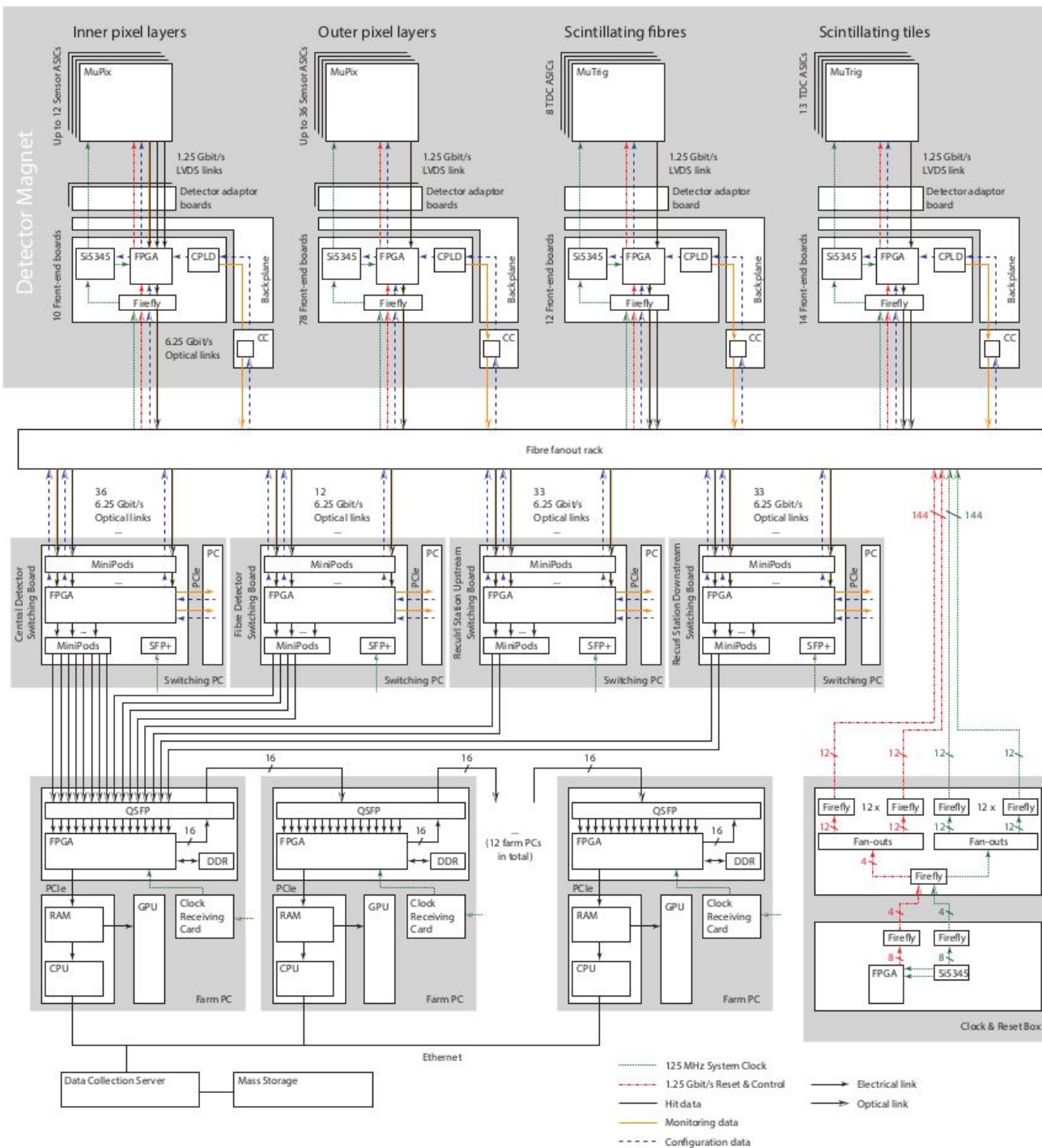

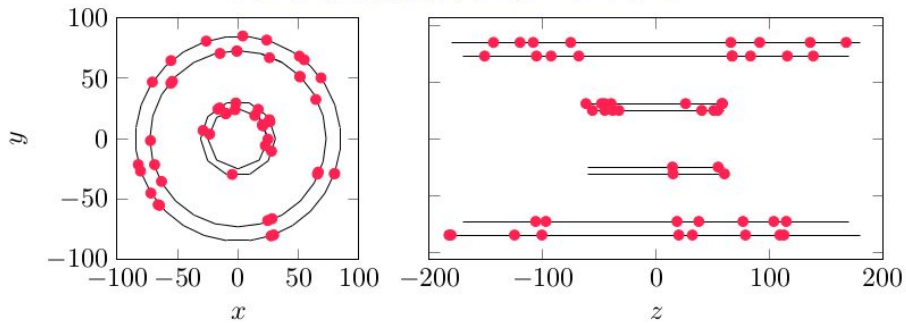
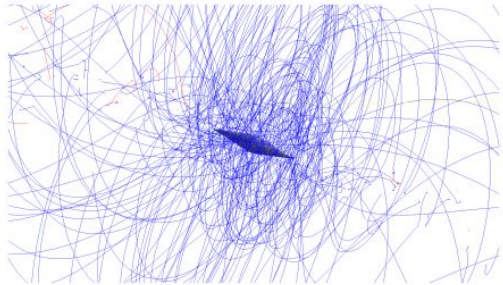

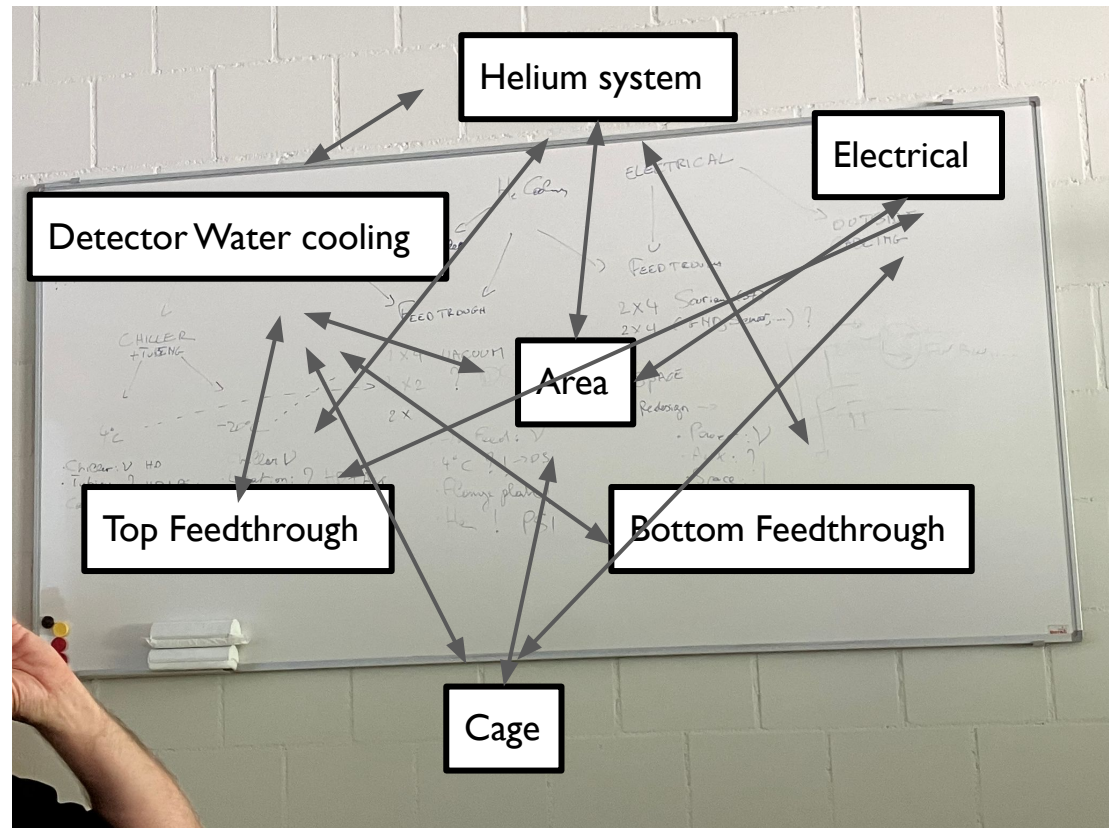

x3

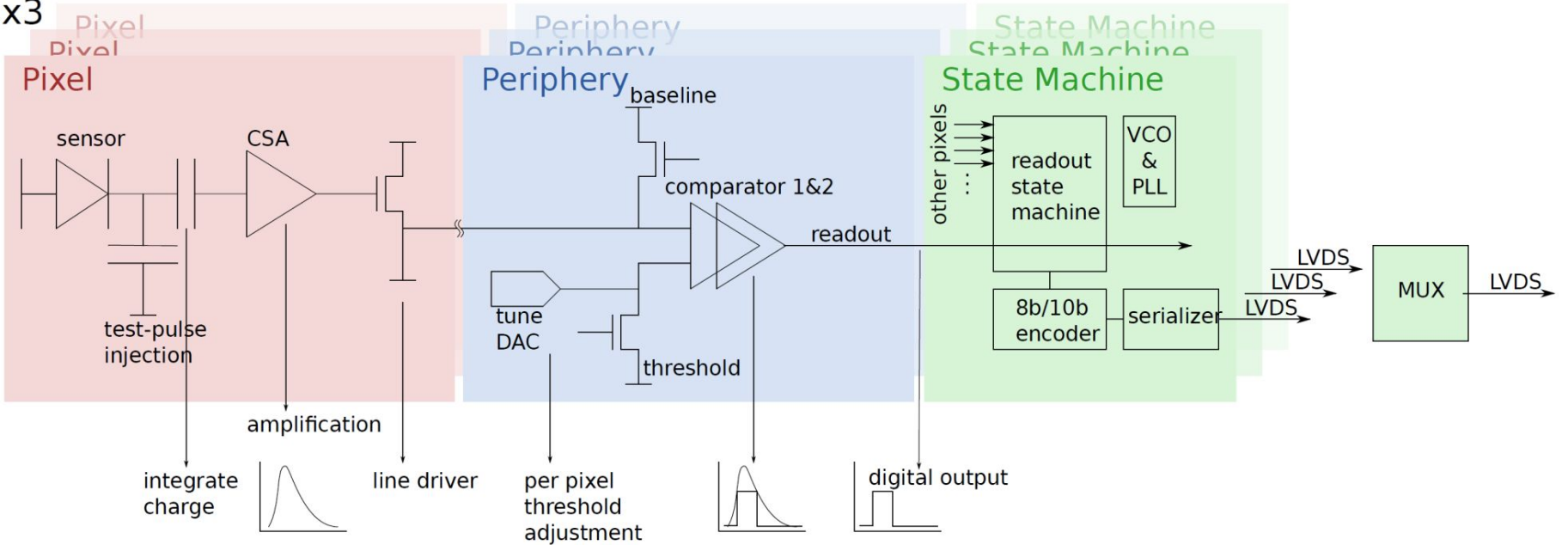

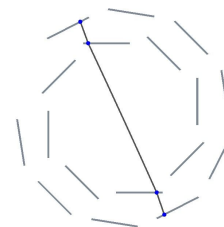
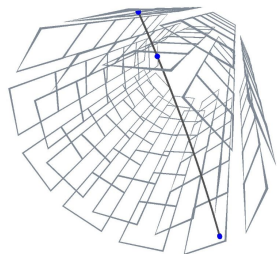

TDiff Pixel - Scifi, require cosmic trigger within 8000ns

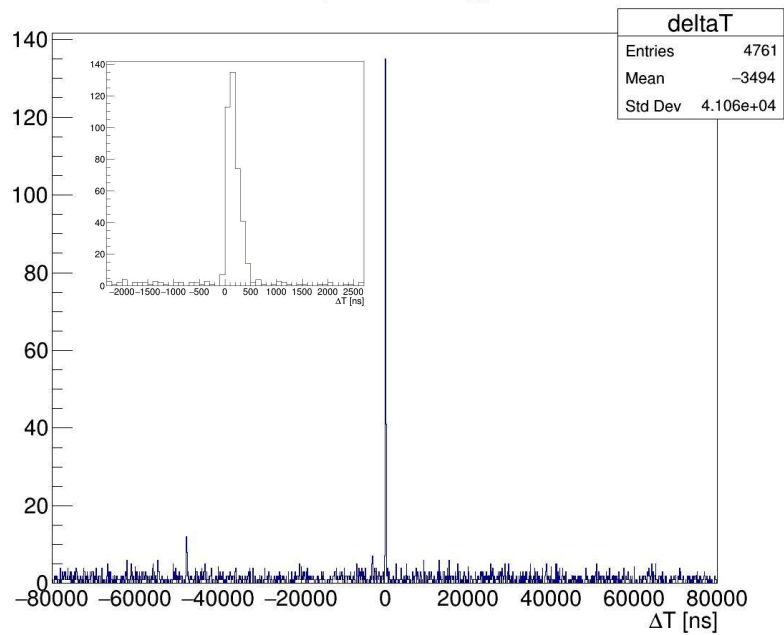

15 copies of 125 MHz global clock & run transition commands

2 Layers of MuPix Chips

inside 1T magnet

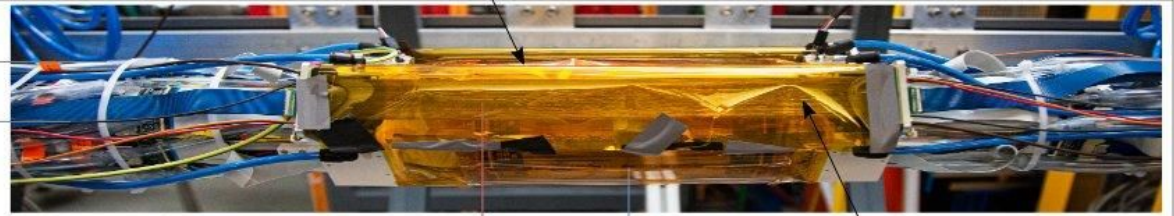

1.25 Gbit/s LVDS Links

2 SciFi ribbons

10 Front-End boards (FEBs)



2 FEBs



6 Gbit/s Fibre Links



Clock & Reset System

1 PCIe40 Board



2 Terasic DE5



10 Gbit/s Fibre Links

Mu3e detector construction & commissioning

We have to build a very compact/complicated detector (+ services + DAQ)

